



Magnetic safety switches RE2 Sensor & actuator

RE21-SA05



Model Name > [RE21-SA05](#)
Part No. > [1059507](#)



At a glance

- Response range of up to 9 mm
- 2 or 3 contacts
- Up to performance level PL e / Cat. 4 (EN ISO 13849)
- Sensors with plug connector or connected cable
- LED status indicator (RE27)
- Flexi Loop-compatible M12 plug connector (depending on variant)

Your benefits

- Long service life due to durable and low-maintenance design
- Just one safety switch in conjunction with a suitable safety module makes it possible to solve applications up to PL e and Cat. 4 (EN ISO 13849)
- High level of machine availability due to high tolerances for door misalignment
- The devices are easy to clean, making them suitable for contaminated areas or environments with strict hygiene standards
- Fast diagnostics via LED status indicator (RE27)
- Flexi Loop now enables a safe series connection with enhanced diagnostics capabilities and minimal wiring effort.

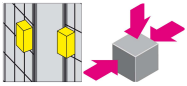

Technical data

Sensor principle:	Magnetic
Category:	Up to category 4 (EN ISO 13849) ¹⁾
Performance level:	Up to PL e (EN ISO 13849) ²⁾
B10d parameter:	2*1E 07 switching cycles, with small load
Housing material:	Glass-fiber reinforced PPS
Enclosure rating:	IP 67 (IEC 60529)
Ambient operating temperature:	-20 °C ... +60 °C
Number of actuation directions:	3
Connection type:	Cable
Flexi Loop-compatible plug connector:	-
Cable length:	5 m
Number of N/C contacts:	1
Number of N/O contacts:	1
Number of signaling contacts:	0
Safe switch on distance Sao:	6 mm
Status display:	-

Design:

Rectangular

Dimensions:

25 mm x 88 mm x 13 mm

Weight:

0.3 kg

1) 2) In combination with a suitable safe evaluation unit

Response range

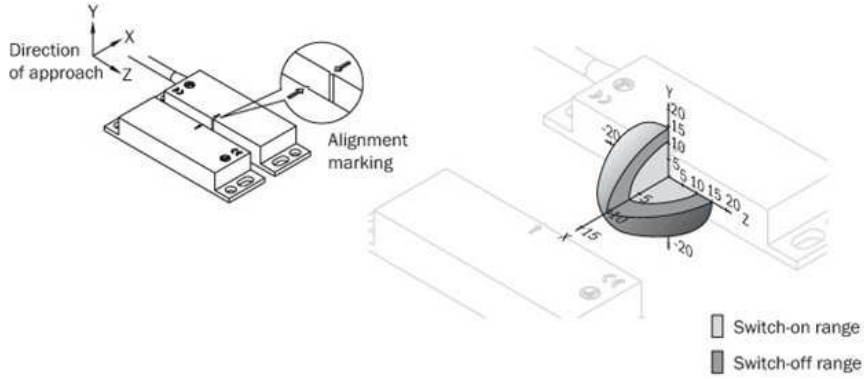

Dimensional drawing

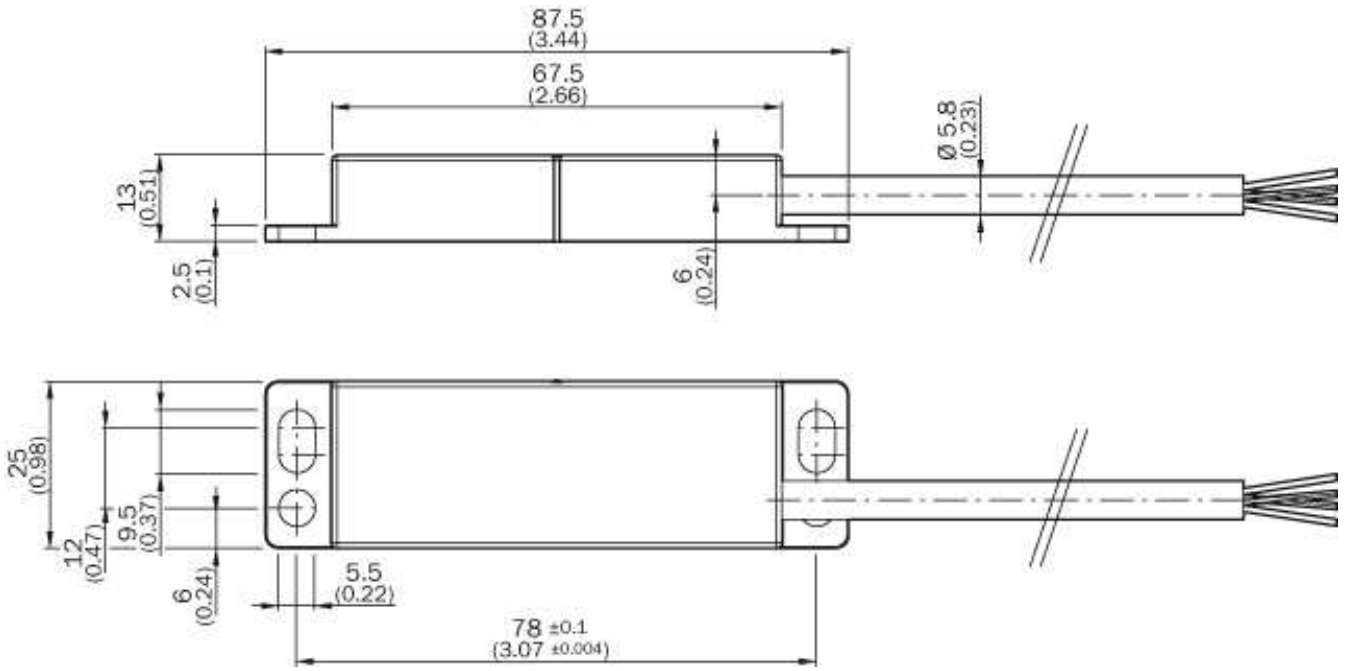

Connection diagram



1 BN	N/O contact
2 WH	N/O contact
3 BU	N/C contact
4 BK	N/C contact

Australia

Phone +61 3 9457 0600
1800 33 48 02 – tollfree
E-Mail sales@sick.com.au

Belgium/Luxembourg

Phone +32 (0)2 466 55 66
E-Mail info@sick.be

Brasil

Phone +55 11 3215-4900
E-Mail marketing@sick.com.br

Canada

Phone +1 905 771 14 44
E-Mail information@sick.com

Česká republika

Phone +420 2 57 91 18 50
E-Mail sick@sick.cz

China

Phone +86 4000 121 000
E-Mail info.china@sick.net.cn
Phone +852-2153 6300
E-Mail ghk@sick.com.hk

Danmark

Phone +45 45 82 64 00
E-Mail sick@sick.dk

Deutschland

Phone +49 211 5301-301
E-Mail info@sick.de

España

Phone +34 93 480 31 00
E-Mail info@sick.es

France

Phone +33 1 64 62 35 00
E-Mail info@sick.fr

Great Britain

Phone +44 (0)1727 831121
E-Mail info@sick.co.uk

India

Phone +91-22-4033 8333
E-Mail info@sick-india.com

Israel

Phone +972-4-6881000
E-Mail info@sick-sensors.com

Italia

Phone +39 02 27 43 41
E-Mail info@sick.it

Japan

Phone +81 (0)3 5309 2112
E-Mail support@sick.jp

Magyarország

Phone +36 1 371 2680
E-Mail office@sick.hu

Nederland

Phone +31 (0)30 229 25 44
E-Mail info@sick.nl

Norge

Phone +47 67 81 50 00
E-Mail sick@sick.no

Österreich

Phone +43 (0)22 36 62 28 8-0
E-Mail office@sick.at

Polska

Phone +48 22 837 40 50
E-Mail info@sick.pl

România

Phone +40 356 171 120
E-Mail office@sick.ro

Russia

Phone +7-495-775-05-30
E-Mail info@sick.ru

Schweiz

Phone +41 41 619 29 39
E-Mail contact@sick.ch

Singapore

Phone +65 6744 3732
E-Mail sales.gsg@sick.com

Slovenija

Phone +386 (0)1-47 69 990
E-Mail office@sick.si

South Africa

Phone +27 11 472 3733
E-Mail info@sickautomation.co.za

South Korea

Phone +82 2 786 6321/4
E-Mail info@sickkorea.net

Suomi

Phone +358-9-25 15 800
E-Mail sick@sick.fi

Sverige

Phone +46 10 110 10 00
E-Mail info@sick.se

Taiwan

Phone +886 2 2375-6288
E-Mail sales@sick.com.tw

Türkiye

Phone +90 (216) 528 50 00
E-Mail info@sick.com.tr

United Arab Emirates

Phone +971 (0) 4 88 65 878
E-Mail info@sick.ae

USA/México

Phone +1(952) 941-6780
1 (800) 325-7425 – tollfree
E-Mail info@sickusa.com

More representatives and agencies
at www.sick.com