



Magnetic Cylinder Sensors Sensors for C-slot cylinders

MZC1-2V2PS-KU0



Model Name > [MZC1-2V2PS-KU0](#)
Part No. > [1059738](#)



At a glance

- Fits into all commonly used cylinders, linear slides and grippers with C-slots, such as, Festo or SMC
- Complete range with PNP / NPN, PUR and PVC cable , M8 and M12 connector
- Combined Allen and flathead installation screw
- Very short sensor housing, making it easier to install on short stroke cylinders
- LED function indicator
- IP 67 / IP 68 / IP 69K enclosure rating (depending on type)

Your benefits

- Reduced maintenance cost as the sensor keeps its position under shock and vibration and does not move out
- Increased machine throughput thanks to SICK' s proprietary GMR technology (giant magneto resistive) as well as the SICK-ASIC (application specific integrated circuit) that ensure precise one-time switching while eliminating false signals
- Flexible installation via Allen wrench or flathead screwdriver
- Time saving single-hand mounting with ¼-turn installation.
- Convenient installation and sensor replacement due to drop-in installation - installer does not need to disassemble the cylinder from the machine for sensor replacement.
- Extremely rugged VISTAL-housing - rated for IP67 respectively IP 68 and IP 69K, enlarging sensor life time



Features

Switching frequency typ.:	1,000 Hz
Output type:	PNP
Output function:	NO
Electrical wiring:	DC 3-wire
Cylinder type:	C-slot
Cylinder types with adapter:	SMC rail cylinder CDQ2 SMC rail cylinder ECDQ2
Housing length:	23.7 mm

According to EN 60529 (IP67/IP68); According to DIN 40050 (IP69K);

Mechanics/electronics

Connection type:	Cable, 3-wire, 2 m
Supply voltage:	10 V DC ... 30 V DC
Power consumption:	$\leq 8 \text{ mA}$ ¹⁾
Voltage drop:	$\leq 2.5 \text{ V}$
Output current I _a :	$\leq 100 \text{ mA}$
EMC:	According to EN 60947-5-2
Cable material:	PUR
Conductor cross-section:	0.09 mm ²
Reverse polarity protection:	✓
Short-circuit protection:	✓
Housing material:	Plastic
Power-up pulse protection:	-
Repeatability:	$\leq 0.1 \text{ mT}$ ²⁾
Overrun distance typ.:	4 mm
Shock and vibration resistance:	30 g, 11 ms/10 ... 55 Hz, 1 mm
Ambient operating temperature:	-30 °C ... 80 °C
Protection class:	III
Hysteresis typ.:	$\leq 0.8 \text{ mT}$
Magnetic field sensitivity, typ.:	2.2 mT

¹⁾ Without load ²⁾ U_b and T_a constant

Dimensional drawing

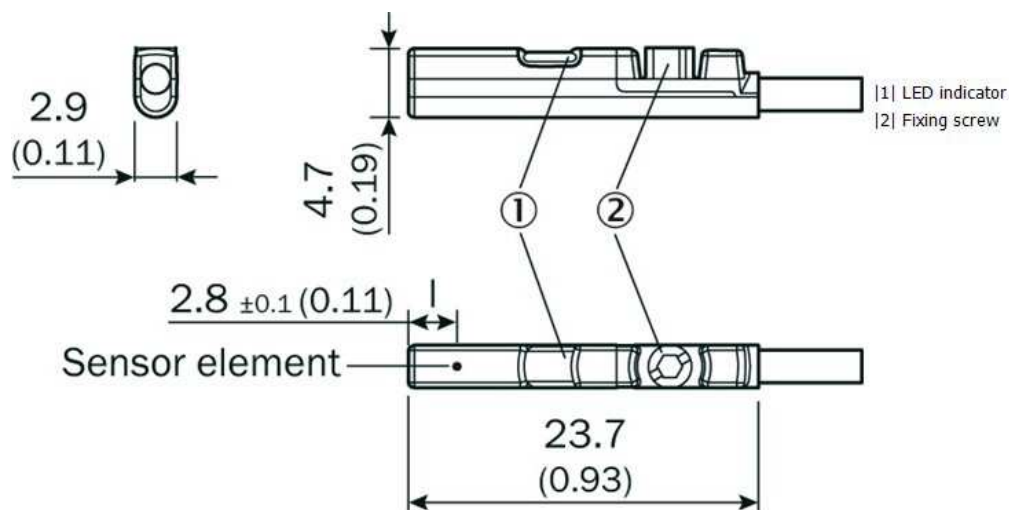

Connection diagram

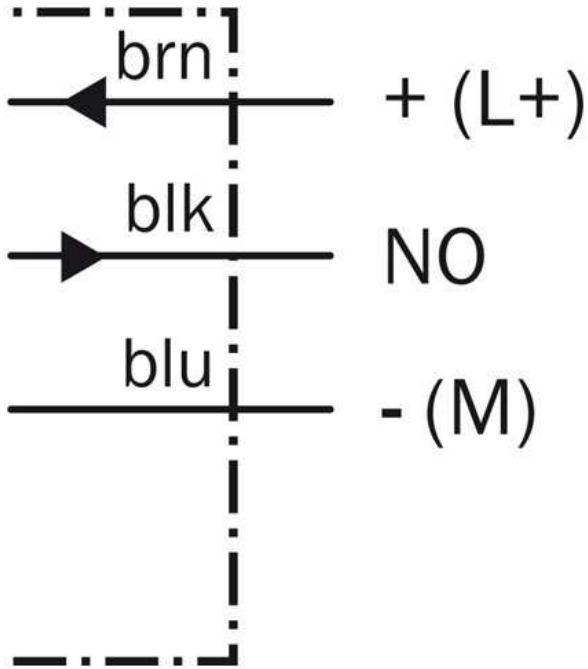

Connection type

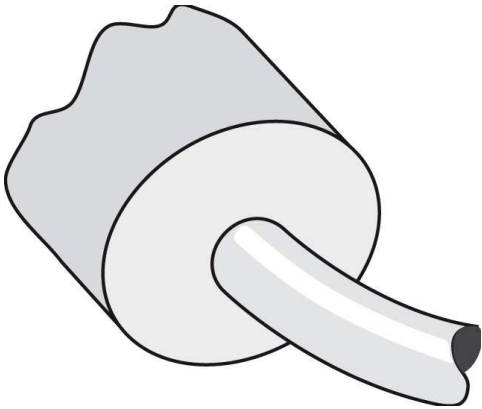

Australia

Phone +61 3 9457 0600
1800 33 48 02 – tollfree
E-Mail sales@sick.com.au

Belgium/Luxembourg

Phone +32 (0)2 466 55 66
E-Mail info@sick.be

Brasil

Phone +55 11 3215-4900
E-Mail marketing@sick.com.br

Canada

Phone +1 905 771 14 44
E-Mail information@sick.com

Česká republika

Phone +420 2 57 91 18 50
E-Mail sick@sick.cz

China

Phone +86 4000 121 000
E-Mail info.china@sick.net.cn
Phone +852-2153 6300
E-Mail ghk@sick.com.hk

Danmark

Phone +45 45 82 64 00
E-Mail sick@sick.dk

Deutschland

Phone +49 211 5301-301
E-Mail info@sick.de

España

Phone +34 93 480 31 00
E-Mail info@sick.es

France

Phone +33 1 64 62 35 00
E-Mail info@sick.fr

Great Britain

Phone +44 (0)1727 831121
E-Mail info@sick.co.uk

India

Phone +91-22-4033 8333
E-Mail info@sick-india.com

Israel

Phone +972-4-6881000
E-Mail info@sick-sensors.com

Italia

Phone +39 02 27 43 41
E-Mail info@sick.it

Japan

Phone +81 (0)3 5309 2112
E-Mail support@sick.jp

Magyarország

Phone +36 1 371 2680
E-Mail office@sick.hu

Nederland

Phone +31 (0)30 229 25 44
E-Mail info@sick.nl

Norge

Phone +47 67 81 50 00
E-Mail sick@sick.no

Österreich

Phone +43 (0)22 36 62 28 8-0
E-Mail office@sick.at

Polska

Phone +48 22 837 40 50
E-Mail info@sick.pl

România

Phone +40 356 171 120
E-Mail office@sick.ro

Russia

Phone +7-495-775-05-30
E-Mail info@sick.ru

Schweiz

Phone +41 41 619 29 39
E-Mail contact@sick.ch

Singapore

Phone +65 6744 3732
E-Mail sales.gsg@sick.com

Slovenija

Phone +386 (0)1-47 69 990
E-Mail office@sick.si

South Africa

Phone +27 11 472 3733
E-Mail info@sickautomation.co.za

South Korea

Phone +82 2 786 6321/4
E-Mail info@sickkorea.net

Suomi

Phone +358-9-25 15 800
E-Mail sick@sick.fi

Sverige

Phone +46 10 110 10 00
E-Mail info@sick.se

Taiwan

Phone +886 2 2375-6288
E-Mail sales@sick.com.tw

Türkiye

Phone +90 (216) 528 50 00
E-Mail info@sick.com.tr

United Arab Emirates

Phone +971 (0) 4 88 65 878
E-Mail info@sick.ae

USA/México

Phone +1(952) 941-6780
1 (800) 325-7425 – tollfree
E-Mail info@sickusa.com

More representatives and agencies
at www.sick.com