



Long range distance sensors Dx100, DL100

DL100-13AA2101



Model Name > **DL100-13AA2101**
Part No. > **1059969**



Illustration may differ

At a glance

- Measuring range up to 220 m (dependent on type)
- Numerous fieldbus interfaces
- Pre-failure notification and diagnostic data available
- Display with intuitive menu structure and clearly visible status LEDs
- Small, rugged metal housing
- 3-axis alignment bracket with quick-lock system as accessory available
- Elongated holes for zero point adjustment when replacing devices

Your benefits

- 100,000 hours of laser service life ensures that the sensor will have a long, useful life with maximum reliability
- Versions with integrated heating enable reliable use at ambient temperatures at up to -40°C. The TPCC cooling housing, available as an option, enables use at up to +75°C
- The numerous interfaces offer a high degree of flexibility as well as rapid communication for maximum productivity
- Pre-failure notification and diagnostic data for maximum plant availability
- Small, rugged metal housing with SpeedCon™ compatible connectors ensures smooth handling - even in confined spaces
- Alignment bracket with quick lock system ensures fast alignment and easy device replacement, reducing maintenance and mounting costs

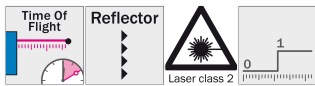

Performance

Measurement range:	0.15 m ... 220 m, On reflective tape "Diamond Grade"
Resolution:	0.1 mm, 0.125 mm, 1 mm, 10 mm, 100 mm
Repeatability ¹⁾ :	2.5 mm (at dead time 10 ms), 1.25 mm (at dead time 30 ms)
Accuracy ²⁾ :	± 5 mm
Light source ³⁾ :	Laser, red
Typ. light spot size (distance):	5 mm (+ 2 mm x distance in m)
Internal measurement cycle:	1 ms
Max. movement speed:	30 m/s
Laser class:	2 (EN 60825-1/CDRH)
Output time:	Synchronous to PLC request (dependent on interfaces)

¹⁾ Statistical error 1 σ, environmental conditions constant, depending on operating mode ²⁾ From 150 mm ... 180 mm measuring range the accuracy can reach ± 4 mm

³⁾ Average service life of 100,000 h at T_A = +25 °C

Interfaces

Data interface:	SSI
Output type ¹⁾ :	B (push/pull) MF1, MF2
Multifunctional input (MF) ²⁾ :	1 x MF1

¹⁾ HIGH > V_S - 3 V / LOW < 2 V ²⁾ HIGH > 12 V / LOW < 3 V

Mechanics/electronics

Supply voltage V _s :	DC 18 V ... 30 V, limit values
Ripple ¹⁾ :	5 V _{pp}
Initialization time ²⁾ :	Typ. 1.5 s
Indication:	6 digit 5 x 7 dot matrix display, LEDs
Weight ³⁾ :	Ca. 800 g ... 1,600 g
Output current I _A ⁴⁾ :	≤ 100 mA
Power consumption:	At 24 V DC < 250 mA
Connection type:	Male connector, M12, SPEEDCON™ compatible
Housing material:	Aluminum/zinc die-cast
Modulation frequency:	Fix

¹⁾ May not fall short of or exceed V_S tolerances ²⁾ After loss of reflector < 40 ms ³⁾ Without mounting bracket: approx. 800 g, with mounting bracket: approx. 1,600 g

⁴⁾ Short circuit/overload protected. Max. 100 nF/20 mH

Ambient data

Enclosure rating:	IP 65
Protection class:	III
Effect of air pressure:	0.3 ppm/hPa
Effect of air temperature:	1 ppm/K
Temperature drift:	Typ. 0.1 mm/K
Ambient temperature ¹⁾ :	Operation: -20 ... +55 °C Operation with cooling case: -20 ... +75 °C Storage: -40 ... +75 °C
Mechanical load:	Noise: EN 600 68-2-64 Shock: EN 600 68-2-27 Sine: EN 600 68-2-6
Electromagnetic compatibility (EMC) ²⁾ :	EN 61000-6-2/EN 61000-6-4

¹⁾ Temperatures < -10 °C require warm-up time of typ. 7 minutes. ²⁾ This is a Class A device. This device can cause radio interference in living quarters.

Dimensional drawing

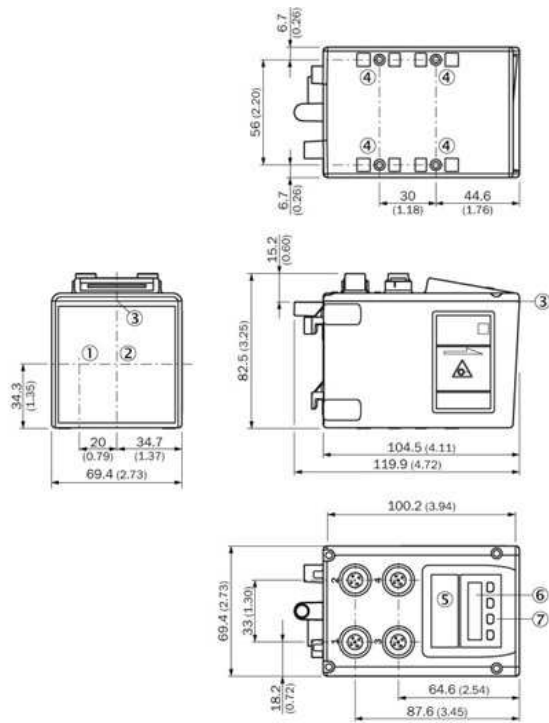

- |1| Optical axis, sender
- |2| Optical axis, receiver
- |3| Zero level
- |4| Threaded mounting hole M5
- |5| Status LED [status]
- |6| Display
- |7| Control elements

Connection type Ethernet

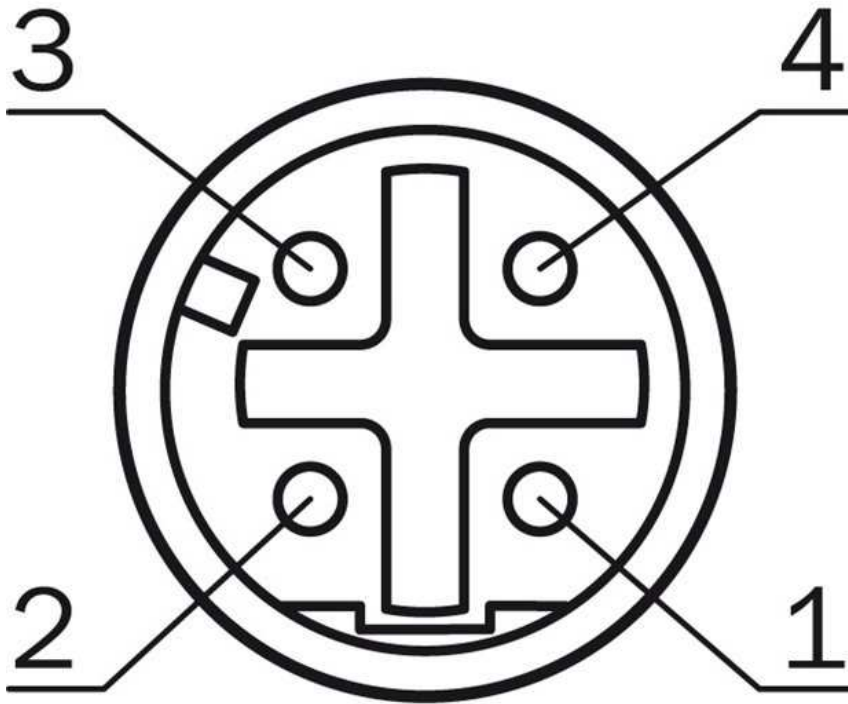

Connection diagram Ethernet

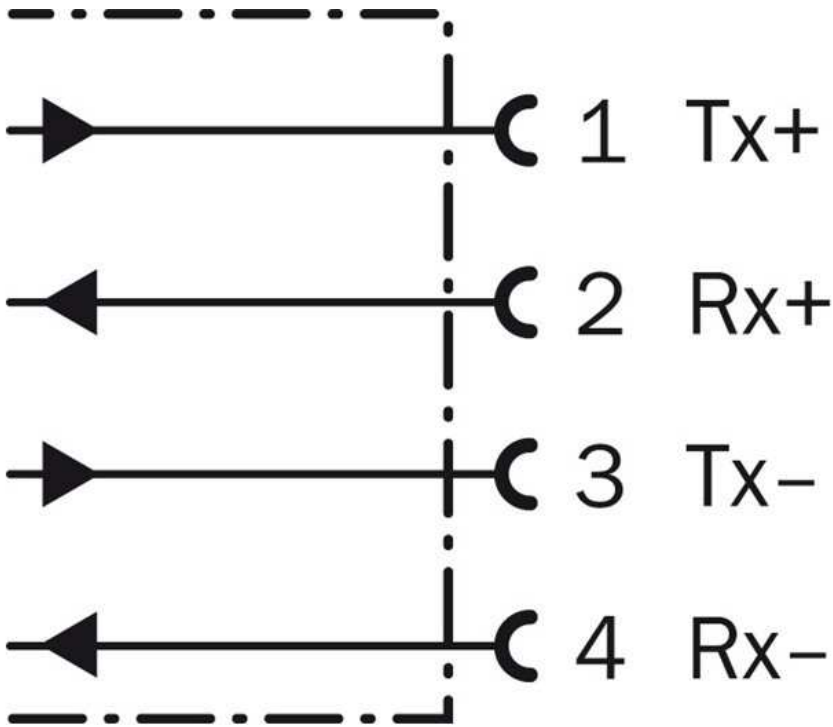

Australia

Phone +61 3 9457 0600
1800 33 48 02 – tollfree
E-Mail sales@sick.com.au

Belgium/Luxembourg

Phone +32 (0)2 466 55 66
E-Mail info@sick.be

Brasil

Phone +55 11 3215-4900
E-Mail marketing@sick.com.br

Canada

Phone +1 905 771 14 44
E-Mail information@sick.com

Česká republika

Phone +420 2 57 91 18 50
E-Mail sick@sick.cz

China

Phone +86 4000 121 000
E-Mail info.china@sick.net.cn
Phone +852-2153 6300
E-Mail ghk@sick.com.hk

Danmark

Phone +45 45 82 64 00
E-Mail sick@sick.dk

Deutschland

Phone +49 211 5301-301
E-Mail info@sick.de

España

Phone +34 93 480 31 00
E-Mail info@sick.es

France

Phone +33 1 64 62 35 00
E-Mail info@sick.fr

Great Britain

Phone +44 (0)1727 831121
E-Mail info@sick.co.uk

India

Phone +91-22-4033 8333
E-Mail info@sick-india.com

Israel

Phone +972-4-6881000
E-Mail info@sick-sensors.com

Italia

Phone +39 02 27 43 41
E-Mail info@sick.it

Japan

Phone +81 (0)3 5309 2112
E-Mail support@sick.jp

Magyarország

Phone +36 1 371 2680
E-Mail office@sick.hu

Nederland

Phone +31 (0)30 229 25 44
E-Mail info@sick.nl

Norge

Phone +47 67 81 50 00
E-Mail sick@sick.no

Österreich

Phone +43 (0)22 36 62 28 8-0
E-Mail office@sick.at

Polska

Phone +48 22 837 40 50
E-Mail info@sick.pl

România

Phone +40 356 171 120
E-Mail office@sick.ro

Russia

Phone +7-495-775-05-30
E-Mail info@sick.ru

Schweiz

Phone +41 41 619 29 39
E-Mail contact@sick.ch

Singapore

Phone +65 6744 3732
E-Mail sales.gsg@sick.com

Slovenija

Phone +386 (0)1-47 69 990
E-Mail office@sick.si

South Africa

Phone +27 11 472 3733
E-Mail info@sickautomation.co.za

South Korea

Phone +82 2 786 6321/4
E-Mail info@sickkorea.net

Suomi

Phone +358-9-25 15 800
E-Mail sick@sick.fi

Sverige

Phone +46 10 110 10 00
E-Mail info@sick.se

Taiwan

Phone +886 2 2375-6288
E-Mail sales@sick.com.tw

Türkiye

Phone +90 (216) 528 50 00
E-Mail info@sick.com.tr

United Arab Emirates

Phone +971 (0) 4 88 65 878
E-Mail info@sick.ae

USA/México

Phone +1(952) 941-6780
1 (800) 325-7425 – tollfree
E-Mail info@sickusa.com

More representatives and agencies
at www.sick.com