



Wire draw encoders
HighLine

BTF08-L1EM03PP



Model Name > **BTF08-L1EM03PP**
Part No. > **1060973**



Illustration may differ

At a glance

- Absolute wire draw encoders
- Modular measuring system with a wide selection of interfaces/measuring lengths
- Measuring lengths: 2 m ... 50 m
- Very rugged system (dirt wiper, integrated brushes), highly shock and vibration resistant
- High-quality winding mechanism and wire input
- Interfaces: - ANALOG, SSI, PROFIBUS, CANopen, DeviceNet, HIPERFACE®
- High enclosure rating
- High resolution possible

Your benefits

- Reliable solution in harsh environments
- Long service life due to rugged industrial housing
- Quick and easy installation without the need for precise linear guidance
- Low integration and maintenance costs
- Customization option reduces storage costs
- No reference run necessary thanks to the absolute measuring principle
- Teach-in function enables fast commissioning



Performance

Measurement range:	0 m ... 3 m
Repeatability:	≤ 1 mm ¹⁾
Linearity:	≤ ± 2 mm ²⁾
Hysteresis:	≤ 2 mm ³⁾
Resolution (wire draw + encoder)::	0.01 mm ^{4) 5)}

^{1) 3)} Value refers to wire draw mechanism ^{2) 4) 5)}

Mechanical data

Mass (including encoder):	1.9 kg
Mass (mechanics):	1.5 kg
Measuring wire diameter:	1.35 mm
Measuring wire material:	Highly flexible stranded steel 1.4401 stainless steel V4A
Housing material, wire draw mechanism:	Aluminum (anodised), die-cast zinc
Spring return force:	6 N ... 14 N ¹⁾
Life of wire draw mechanism:	1 million cycles ²⁾

Actual length of cable extension:	3.2 m
Wire acceleration:	40 m/s ²
Operating speed:	4 m/s
Mounted encoder:	ACM60
Mounted mechanic:	MRA-F080-103D2
Part number mechanic:	6030125
Part number encoder:	6045313
Mass (measuring wire):	7.1 g/m
Length of wire pulled out per revolution:	200 mm ³⁾

1) These values were measured at an ambient temperature of 25 °C. There may be variations at other temperatures. 2) 3)

Electrical data

Initialization time:	≤ 2 ms ¹⁾
Supply voltage:	18 V ... 33 V
Power consumption:	2 W

1) Valid positional data can be read once this time has elapsed.

Interfaces

Electrical interface:	0 V ... 10 V, Analog
Connection type:	Connector 1 x M12, 5-pin, radial
Clock frequency:	32 kHz
SET (electronic adjustment):	Über Programmierfolie
Encoder:	Absolute encoders

Ambient data

EMC:	(according to EN 61000-6-2 and EN 61000-6-3)
Enclosure rating encoder:	IP 65
Enclosure rating mechanic:	IP 64
Resistance to shocks:	50 g, 6 ms (according to EN 60068-2-27)
Resistance to vibration:	4 g, Sinus 5 Hz ... 100 Hz (according to EN 60068-2-6)
Working temperature range (encoder):	-30 °C ... +70 °C
Working temperature range (mechanics):	-30 °C ... +70 °C
Working temperature range (combination):	Wird definiert durch den höheren minimalen und niedrigeren maximalen Wert des Arbeitstemperaturbereichs von Encoder und Mechanik

Dimensional drawing

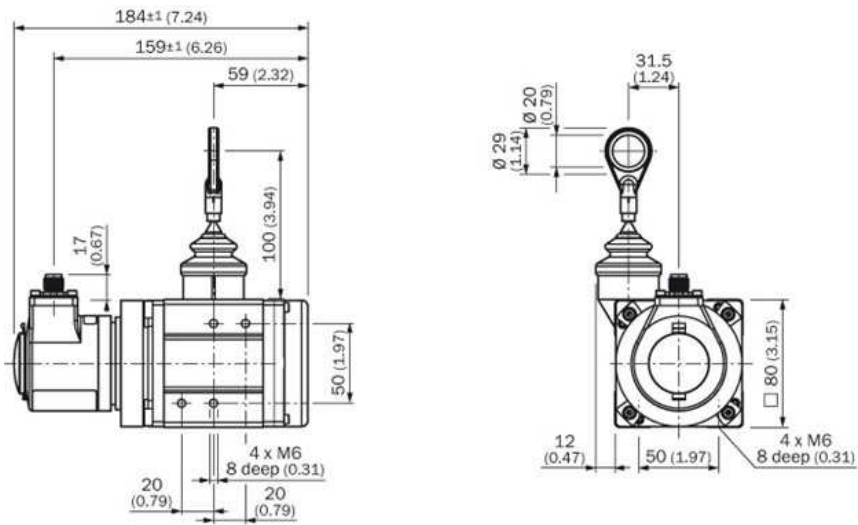

Australia

Phone +61 3 9457 0600
1800 33 48 02 – tollfree
E-Mail sales@sick.com.au

Belgium/Luxembourg

Phone +32 (0)2 466 55 66
E-Mail info@sick.be

Brasil

Phone +55 11 3215-4900
E-Mail marketing@sick.com.br

Canada

Phone +1 905 771 14 44
E-Mail information@sick.com

Česká republika

Phone +420 2 57 91 18 50
E-Mail sick@sick.cz

China

Phone +86 4000 121 000
E-Mail info.china@sick.net.cn
Phone +852-2153 6300
E-Mail ghk@sick.com.hk

Danmark

Phone +45 45 82 64 00
E-Mail sick@sick.dk

Deutschland

Phone +49 211 5301-301
E-Mail info@sick.de

España

Phone +34 93 480 31 00
E-Mail info@sick.es

France

Phone +33 1 64 62 35 00
E-Mail info@sick.fr

Great Britain

Phone +44 (0)1727 831121
E-Mail info@sick.co.uk

India

Phone +91-22-4033 8333
E-Mail info@sick-india.com

Israel

Phone +972-4-6881000
E-Mail info@sick-sensors.com

Italia

Phone +39 02 27 43 41
E-Mail info@sick.it

Japan

Phone +81 (0)3 5309 2112
E-Mail support@sick.jp

Magyarország

Phone +36 1 371 2680
E-Mail office@sick.hu

Nederland

Phone +31 (0)30 229 25 44
E-Mail info@sick.nl

Norge

Phone +47 67 81 50 00
E-Mail sick@sick.no

Österreich

Phone +43 (0)22 36 62 28 8-0
E-Mail office@sick.at

Polska

Phone +48 22 837 40 50
E-Mail info@sick.pl

România

Phone +40 356 171 120
E-Mail office@sick.ro

Russia

Phone +7-495-775-05-30
E-Mail info@sick.ru

Schweiz

Phone +41 41 619 29 39
E-Mail contact@sick.ch

Singapore

Phone +65 6744 3732
E-Mail sales.gsg@sick.com

Slovenija

Phone +386 (0)1-47 69 990
E-Mail office@sick.si

South Africa

Phone +27 11 472 3733
E-Mail info@sickautomation.co.za

South Korea

Phone +82 2 786 6321/4
E-Mail info@sickkorea.net

Suomi

Phone +358-9-25 15 800
E-Mail sick@sick.fi

Sverige

Phone +46 10 110 10 00
E-Mail info@sick.se

Taiwan

Phone +886 2 2375-6288
E-Mail sales@sick.com.tw

Türkiye

Phone +90 (216) 528 50 00
E-Mail info@sick.com.tr

United Arab Emirates

Phone +971 (0) 4 88 65 878
E-Mail info@sick.ae

USA/México

Phone +1(952) 941-6780
1 (800) 325-7425 – tollfree
E-Mail info@sickusa.com

More representatives and agencies
at www.sick.com