



Incremental encoders DBS36 Core

DBS36E-BBEJ00360



Model Name > [DBS36E-BBEJ00360](#)
Part No. > [1061254](#)



Illustration may differ

At a glance

- Connection with universal cable outlet
- Versions with blind hollow shaft or face mount flange with solid shaft
- Face mount flange with 3 mounting hole patterns and servo groove
- Hollow shaft with universal stator coupling
- Compact diameter of 37 mm
- Electrical interfaces: TTL/RS-422, HTL/push pull and Open Collector NPN
- Available PPR: 10 to 2,500
- Temperature range: -20 °C ... +85 °C
- Enclosure rating: IP 65

Your benefits

- The universal cable outlet allows use in tight spaces and makes flexible cable routing possible
- Face mount flange with various mounting hole patterns provides flexibility when mounting in new or existing applications
- Face mount flange with servo groove makes mounting with servo clamps possible
- The DBS36 Core's universal stator coupling ensures easy device replacement without changing the application
- Shafts with metric and inch dimension allow global use
- The high flexibility of the encoders' mechanical interface and the available accessories make it possible to use one design in many applications
- Permanent and safe operation due to a high enclosure rating, temperature resistance and a long bearing lifetime



Performance

Error limits:	± 54 ° (/pulses per revolution)
Measuring step deviation:	± 18 ° /impulses per revolution
Measuring step:	90 ° /electronically/pulses
Initialization time:	< 3 ms
Pulses per revolution:	360
Duty cycle:	≤ 0.5 ± 5 %

Mechanical data

Mechanical interface:	Blind hollow shaft
Shaft diameter:	8 mm
Start up torque:	0.5 Ncm (+20 °C)
Operating torque:	0.4 Ncm (+20 °C)

Permissible movement axial static/dynamic:	± 0.5 mm, ± 0.2 mm
Permissible movement radial static/dynamic:	± 0.3 mm, ± 0.1 mm
Maximum operating speed:	8,000 U/min ¹⁾
Moment of inertia of the rotor:	0.8 gcm ²
Bearing lifetime:	2 x 10 ⁹ revolutions
Max. angular acceleration:	500,000 rad/s ²
Shaft material:	Stainless steel
Operating speed:	6,000 /min ²⁾
Flange material:	Aluminum
Housing material:	Aluminum
Material, cable:	PVC

¹⁾ No permanent operation. Decreasing signal quality. ²⁾ Self-warming 4.7 K per 1,000 1/min

Electrical data

Electrical interface:	7 V ... 30 V, HTL/Push pull
Connection type:	Cable, 8-wire, universal, 0.5 m
Maximum output frequency:	300 kHz
Reference signal, number:	1
Reference signal, position:	90 °, electronically, gated with A and B
Operating voltage range:	7 V ... 30 V
Load current max.:	30 mA
MTTFd: mean time to dangerous failure:	600 a (EN ISO 13849-1) ¹⁾
Power consumption max. without load:	< 0.5 W (without load)
Short-circuit protection of the outputs:	1 ²⁾
Reverse polarity protection:	1

¹⁾ This product is a standard product and does not constitute a safety component as defined in the Machinery Directive.

Calculation based on nominal load of components, average ambient temperature 40°C, frequency of use 8760 h/a. All

electronic failures are considered hazardous. For more information, see document no. 8015532. ²⁾ The short-circuit rating is only given if Us and GND are connected correctly.

Ambient data

EMC:	(according to EN 61000-6-2 and EN 61000-6-4 (class A))
Working temperature range:	-20 °C ... +85 °C
Storage temperature range:	-40 °C ... +100 °C, without package
Resistance to shocks:	100 g (EN 60068-2-27)
Resistance to vibration:	20 g, 10 Hz ... 2,000 Hz (EN 60068-2-6)
Enclosure rating:	IP 65
Permissible relative humidity:	90 % (condensation of the optical scanning not permitted)

Dimensional drawing



Proposed fitting

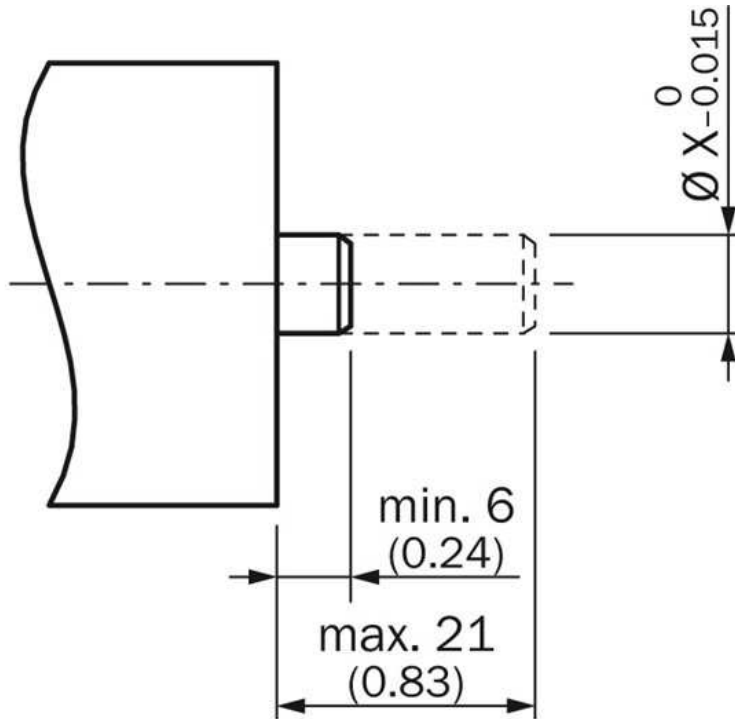

PIN assignment

8-core cable

View of M12 device connector on cable



View of M23 device connector on cable

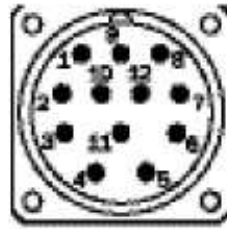

PIN, 8-pole in M12	PIN, 12-pole in M23	Color of wires	Signal OC	Signal TTL, HTL	Explanation
1	6	Brown	Not connected	\bar{A}	Signal line
2	5	White	A	A	Signal line
3	1	Black	Not connected	\bar{B}	Signal line
4	8	Pink	B	B	Signal line
5	4	Yellow	Not connected	\bar{Z}	Signal line
6	3	Lilac	Z	Z	Signal line
7	10	Blue	GND	GND	Ground connection of the encoder
8	12	Red	+U _s	+U _s	Supply voltage
-	9	-	Not connected	Not connected	Not connected
-	2	-	Not connected	Not connected	Not connected
-	11	-	Not connected	Not connected	Not connected
-	7	-	Not connected	Not connected	Not connected
Screen	Screen	Screen	Screen	Screen	Screen connected to encoder housing

Type code

Mechanical design

B Blind hollow shaft, Ø 8 mm

Electrical interface

A 4,5 ... 5,5 V, TTL/RS-422, 6 Channel

C 7 ... 30 V, TTL/RS-422, 6 Channel

E 7 ... 30 V, HTL/push pull, 6 Channel

P 4,5 ... 5,5 V, Open Collector, 3 Channel

Connection type

J 8-core cable, universal 0,5 m

K 8-core cable, universal 1,5 m

L 8-core cable, universal 3 m

P 8-core cable, universal 0,5 m, with M12 plug

Resolution

00100 ... 02500 Pulses per revolution possible. Pulses see "Pulses per revolution"



Australia

Phone +61 3 9457 0600
1800 33 48 02 – tollfree
E-Mail sales@sick.com.au

Belgium/Luxembourg

Phone +32 (0)2 466 55 66
E-Mail info@sick.be

Brasil

Phone +55 11 3215-4900
E-Mail marketing@sick.com.br

Canada

Phone +1 905 771 14 44
E-Mail information@sick.com

Česká republika

Phone +420 2 57 91 18 50
E-Mail sick@sick.cz

China

Phone +86 4000 121 000
E-Mail info.china@sick.net.cn
Phone +852-2153 6300
E-Mail ghk@sick.com.hk

Danmark

Phone +45 45 82 64 00
E-Mail sick@sick.dk

Deutschland

Phone +49 211 5301-301
E-Mail info@sick.de

España

Phone +34 93 480 31 00
E-Mail info@sick.es

France

Phone +33 1 64 62 35 00
E-Mail info@sick.fr

Great Britain

Phone +44 (0)1727 831121
E-Mail info@sick.co.uk

India

Phone +91-22-4033 8333
E-Mail info@sick-india.com

Israel

Phone +972-4-6881000
E-Mail info@sick-sensors.com

Italia

Phone +39 02 27 43 41
E-Mail info@sick.it

Japan

Phone +81 (0)3 5309 2112
E-Mail support@sick.jp

Magyarország

Phone +36 1 371 2680
E-Mail office@sick.hu

Nederland

Phone +31 (0)30 229 25 44
E-Mail info@sick.nl

Norge

Phone +47 67 81 50 00
E-Mail sick@sick.no

Österreich

Phone +43 (0)22 36 62 28 8-0
E-Mail office@sick.at

Polska

Phone +48 22 837 40 50
E-Mail info@sick.pl

România

Phone +40 356 171 120
E-Mail office@sick.ro

Russia

Phone +7-495-775-05-30
E-Mail info@sick.ru

Schweiz

Phone +41 41 619 29 39
E-Mail contact@sick.ch

Singapore

Phone +65 6744 3732
E-Mail sales.gsg@sick.com

Slovenija

Phone +386 (0)1-47 69 990
E-Mail office@sick.si

South Africa

Phone +27 11 472 3733
E-Mail info@sickautomation.co.za

South Korea

Phone +82 2 786 6321/4
E-Mail info@sickkorea.net

Suomi

Phone +358-9-25 15 800
E-Mail sick@sick.fi

Sverige

Phone +46 10 110 10 00
E-Mail info@sick.se

Taiwan

Phone +886 2 2375-6288
E-Mail sales@sick.com.tw

Türkiye

Phone +90 (216) 528 50 00
E-Mail info@sick.com.tr

United Arab Emirates

Phone +971 (0) 4 88 65 878
E-Mail info@sick.ae

USA/México

Phone +1(952) 941-6780
1 (800) 325-7425 – tollfree
E-Mail info@sickusa.com

More representatives and agencies
at www.sick.com