



Motor feedback systems rotary incremental with  
commutation  
CFS50

CFS50-AFV12X06



**Model Name** > CFS50-AFV12X06  
**Part No.** > 1061648

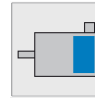

*Illustration may differ*

**At a glance**

- Output driver for incremental and commutation signals as per EIA 422
- Resolution of up to 65,536 lines per revolution
- Commutation signals up to 32 pole pairs
- Temperature range from -20 °C to +115 °C
- Various mechanical interfaces

**Your benefits**

- High level of flexibility due to mechanics already proven in other motor feedback systems
- High level of compatibility thanks to standard interface
- Time-saving due to electrical zero adjustment

**Performance**

Number of lines per revolution:	4,096 <sup>1)</sup>
Measuring step:	90 ° /number of lines
Commutation signals:	6 pole pairs
Reference signal, number:	1
Reference signal, position:	90 ° electronically, gated with A and B
Operating speed:	6,000 /min

<sup>1)</sup> Number of lines from 1 ... 1.000 and > 4.096 ... 65.536 on request

**Mechanical data**

Shaft version:	Tapered shaft
Flange type/stator coupling:	Spring mounting plate
Dimensions:	See dimensional drawing
Mass:	0.1 kg
Moment of inertia of the rotor:	10 gcm <sup>2</sup>
Maximum operating speed:	12,000 /min
Maximum angular acceleration:	200,000 rad/s <sup>2</sup>
Operating torque:	0.2 Ncm
Start up torque:	0.4 Ncm
Permissible shaft movement, radial, static:	± 0.5 mm
Permissible shaft movement, radial, dynamic:	± 0.1 mm
Permissible shaft movement, axial, static:	± 0.75 mm
Permissible shaft movement, axial, dynamic:	± 0.2 mm
Life of ball bearings:	3.6 x 10 <sup>9</sup> revolutions

Connection type:	Stranded cable, 15-pin, radial
Angular motion perpendicular to the rotational axis, static:	± 0.005 mm/mm
Angular motion perpendicular to the rotational axis, dynamic:	± 0.002 mm/mm

#### Electrical data

---

Electrical interface:	TTL/RS422
Operating voltage range/supply Voltage:	4.5 V DC ... 5.5 V DC
Maximum output frequency:	820 kHz
Operating power consumption (no load):	60 mA <sup>1)</sup>

<sup>1)</sup> Without load

#### Ambient data

---

Working temperature range:	-20 °C ... 115 °C
Storage temperature range:	-40 °C ... 125 °C, without package
Relative humidity/Condensation:	90 %, Condensation not permitted
Resistance to shocks:	100 g/10 ms/according to EN 60068-2-27
Resistance to vibration:	20 g/10 Hz/2,000 Hz/according to EN 60068-2-6
EMC:	(according to EN 61000-6-2 and EN 61000-6-3) <sup>1)</sup>
Enclosure rating:	IP 40 (according to IEC 60529)

<sup>1)</sup> The EMC according to the standards quoted is achieved when the motor feedback system is mounted in an electrically conductive housing, which is connected to the central earthing point of the motor controller via a cable screen. This is also where the GND (0 V) connection of the power supply voltage is linked to earth. Users must perform their own tests when other screen designs are used.

## Dimensional drawing

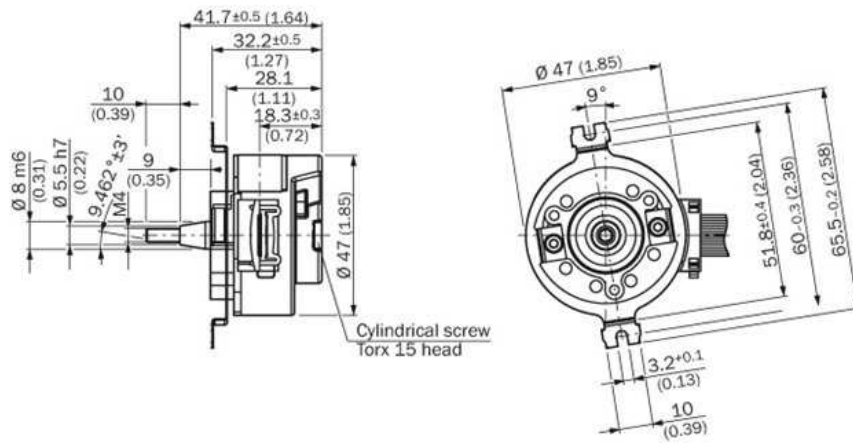

All dimensions in mm (inch)

## Incremental track

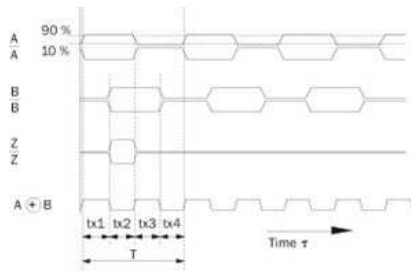

At constant rotational speed with regard to the input shaft and rotation in clockwise direction.

By connecting the two signals A and B, an output signal arises whose period durations tx1 ... tx4 have varying lengths.

The differences are determined:

- by the pulse/pause ratio tolerance of the individual channels
- by the tolerance in the  $90^\circ$  phase shift between A and B
- by the frequency

The times tx1 ... tx4 ideally have to amount to  $1/4$  of the particular period duration T. The typical output frequency of the encoder is defined so that the max. time tx is smaller than  $1.5 \times T/4$ .

## Pulse time diagram

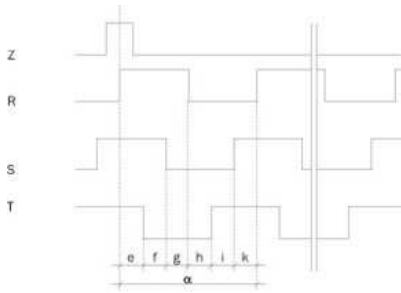

Polepairs	Number of poles	e, f, g, h, i, k	$\alpha$
2	4	30°	180°
3	6	20°	120°
4	8	15°	90°
6	12	10°	60°
8	16	7.5°	45°

The angle information is related to a mechanical shaft rotation. Flank precision of the signals R, S, T  $\pm 1^\circ$ .

## Wire allocation

PIN	Color	Signal
1	Blue	Ground connection (GND)
2	Red	Supply voltage 5 V $\pm 10\%$ ( $U_{cc}$ )
3	Yellow	Reference signal inverted ( $\bar{Z}$ )
4	Purple	Reference signal (Z)
5	Brown	Increment signal inverted ( $\bar{A}$ )
6	White	Increment signal (A)
7	Black	Increment signal inverted ( $\bar{B}$ )
8	Pink	Increment signal (B)
9	White/Red	Commutation signal inverted ( $\bar{T}$ )
10	White/Gray	Commutation signal (T)
11	White/Blue	Commutation signal inverted ( $\bar{S}$ )
12	White/Yellow	Commutation signal (S)
13	White/Pink	Commutation signal inverted ( $\bar{R}$ )
14	White/Green	Commutation signal (R)
15	Gray	Electronic setting of the commutation signals (SET0)

**Australia**

Phone +61 3 9457 0600  
1800 33 48 02 – tollfree  
E-Mail sales@sick.com.au

**Belgium/Luxembourg**

Phone +32 (0)2 466 55 66  
E-Mail info@sick.be

**Brasil**

Phone +55 11 3215-4900  
E-Mail marketing@sick.com.br

**Canada**

Phone +1 905 771 14 44  
E-Mail information@sick.com

**Česká republika**

Phone +420 2 57 91 18 50  
E-Mail sick@sick.cz

**China**

Phone +86 4000 121 000  
E-Mail info.china@sick.net.cn  
Phone +852-2153 6300  
E-Mail ghk@sick.com.hk

**Danmark**

Phone +45 45 82 64 00  
E-Mail sick@sick.dk

**Deutschland**

Phone +49 211 5301-301  
E-Mail info@sick.de

**España**

Phone +34 93 480 31 00  
E-Mail info@sick.es

**France**

Phone +33 1 64 62 35 00  
E-Mail info@sick.fr

**Great Britain**

Phone +44 (0)1727 831121  
E-Mail info@sick.co.uk

**India**

Phone +91-22-4033 8333  
E-Mail info@sick-india.com

**Israel**

Phone +972-4-6881000  
E-Mail info@sick-sensors.com

**Italia**

Phone +39 02 27 43 41  
E-Mail info@sick.it

**Japan**

Phone +81 (0)3 5309 2112  
E-Mail support@sick.jp

**Magyarország**

Phone +36 1 371 2680  
E-Mail office@sick.hu

**Nederland**

Phone +31 (0)30 229 25 44  
E-Mail info@sick.nl

**Norge**

Phone +47 67 81 50 00  
E-Mail sick@sick.no

**Österreich**

Phone +43 (0)22 36 62 28 8-0  
E-Mail office@sick.at

**Polska**

Phone +48 22 837 40 50  
E-Mail info@sick.pl

**România**

Phone +40 356 171 120  
E-Mail office@sick.ro

**Russia**

Phone +7-495-775-05-30  
E-Mail info@sick.ru

**Schweiz**

Phone +41 41 619 29 39  
E-Mail contact@sick.ch

**Singapore**

Phone +65 6744 3732  
E-Mail sales.gsg@sick.com

**Slovenija**

Phone +386 (0)1-47 69 990  
E-Mail office@sick.si

**South Africa**

Phone +27 11 472 3733  
E-Mail info@sickautomation.co.za

**South Korea**

Phone +82 2 786 6321/4  
E-Mail info@sickkorea.net

**Suomi**

Phone +358-9-25 15 800  
E-Mail sick@sick.fi

**Sverige**

Phone +46 10 110 10 00  
E-Mail info@sick.se

**Taiwan**

Phone +886 2 2375-6288  
E-Mail sales@sick.com.tw

**Türkiye**

Phone +90 (216) 528 50 00  
E-Mail info@sick.com.tr

**United Arab Emirates**

Phone +971 (0) 4 88 65 878  
E-Mail info@sick.ae

**USA/México**

Phone +1(952) 941-6780  
1 (800) 325-7425 – tollfree  
E-Mail info@sickusa.com

More representatives and agencies  
at [www.sick.com](http://www.sick.com)