



Photoelectric sensors
G10, Through-beam photoelectric sensor

GSE10-P4221



Model Name > GSE10-P4221
Part No. > 1065906



Illustration may differ

At a glance

- Long sensing ranges: up to 40 m
- PinPoint LED with bright and precise light spot
- With or without sensitivity adjustment
- 10 V DC ... 30 V DC or 24 V AC/DC ... 240 V AC/DC power supply with PNP/NPN or relay output
- Small housing design
- Rugged sensor housing with metal-reinforced holes for assembly
- Weatherproof housing: ideal for outdoor applications

Your benefits

- Long sensing ranges for maximum operating reserves
- Universal DC or AC/DC power supply for even greater application flexibility
- Highly reliable and durable despite optical interference or mechanical loads
- Wide range of accessories simplifies sensor integration: aids for assembly and connectors
- Long service life even when used in outdoor applications thanks to rugged weatherproof housing



Features

Sensor/detection principle:	Through-beam photoelectric sensor
Dimensions (W x H x D):	20 mm x 50 mm x 39 mm
Housing design (light emission):	Rectangular
Sensing range max.:	0 m ... 40 m
Sensing range:	0 m ... 35 m
Type of light:	Infrared light
Light source:	LED ¹⁾
Wave length:	850 nm
Adjustment:	Potentiometer, 270 °
Light spot size (distance):	Ø 433 mm (15 m)

¹⁾ Average service life: 100,000 h at T_U = +25 °C

Mechanics/electronics

Supply voltage:	10 V DC ... 30 V DC ¹⁾
Ripple:	± 5 Vpp ²⁾
Power consumption, sender:	≤ 15 mA

Output type:	PNP
Switching mode:	Light/dark switching
Switching mode selector:	Selectable via light/dark selector
Output current I _{max} ·:	≤ 100 mA
Response time:	≤ 500 μs ³⁾
Connection type:	Connector M12, 4-pin
Circuit protection:::	A, B, C, D ^{4) 5) 6) 7)}
Protection class:	III
Weight:	70 g
Polarisation filter:	-
Special device:	-
Enclosure rating:	IP 67
EMC:	EN 60947-5-2
Test input:	-
Ambient temperature operation:	-30 °C ... +60 °C
Ambient storage temperature:	-40 °C ... +70 °C
UL File No.:	NRKH.E348498 & NRKH7.E348498
Further standards:	UL325 ⁸⁾
Switching frequency max.:	1,000 Hz ⁹⁾
Housing material:	PVC/PMMA, Plastic

1) Limit values when operated in short-circuit protected network: max. 8 A²⁾ May not exceed or fall below U_v tolerances³⁾ Signal transit time with resistive load⁴⁾ A = V_S connections reverse-polarity protected⁵⁾ B = inputs and output reverse-polarity protected⁶⁾ C = interference suppression⁷⁾ D = outputs overcurrent and short-circuit protected⁸⁾ Complies with the UL325 standard when used with sturdy protection hood (e.g. BEF-G10WSG, 2071960).⁹⁾ With light/dark ratio 1:1

Dimensional drawing

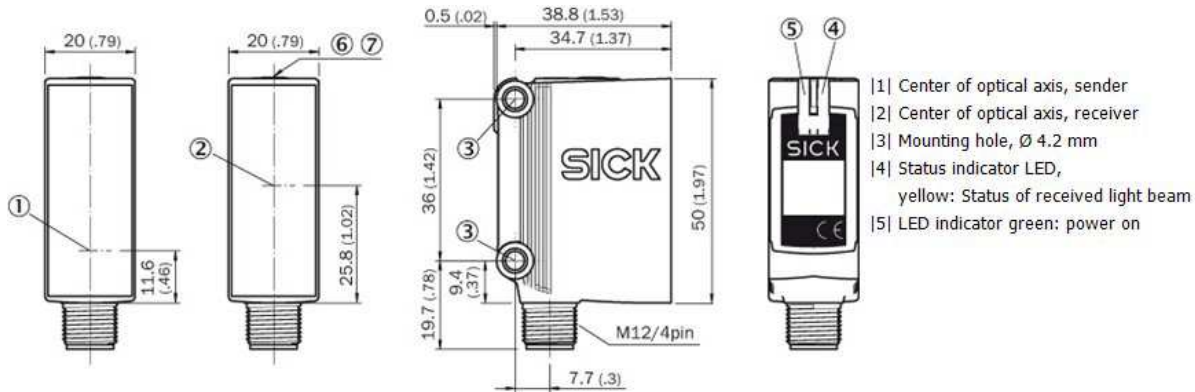

Adjustments possible

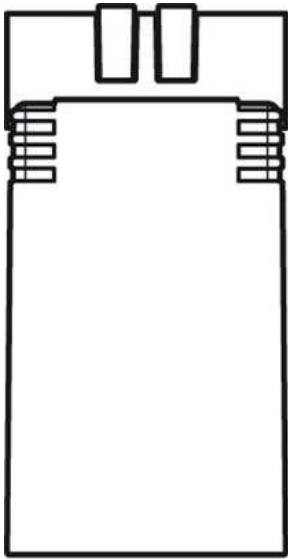

8

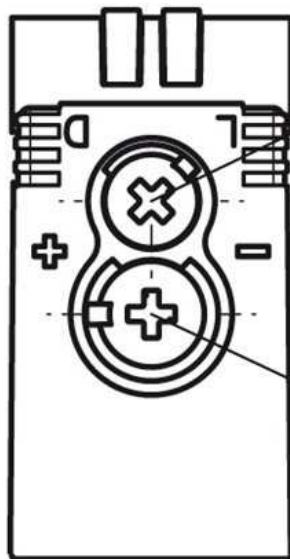

9

- 6| Sensing range adjustment
- 7| Light/dark selector
- 8| sender
- 9| receiver

Connection diagram

1

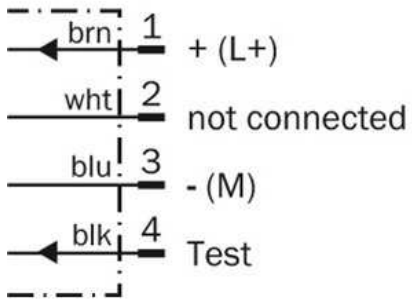

2

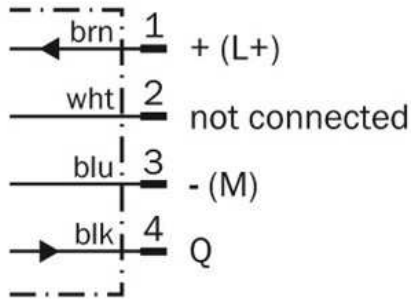

- 1| sender
- 2| receiver

Operating reserve

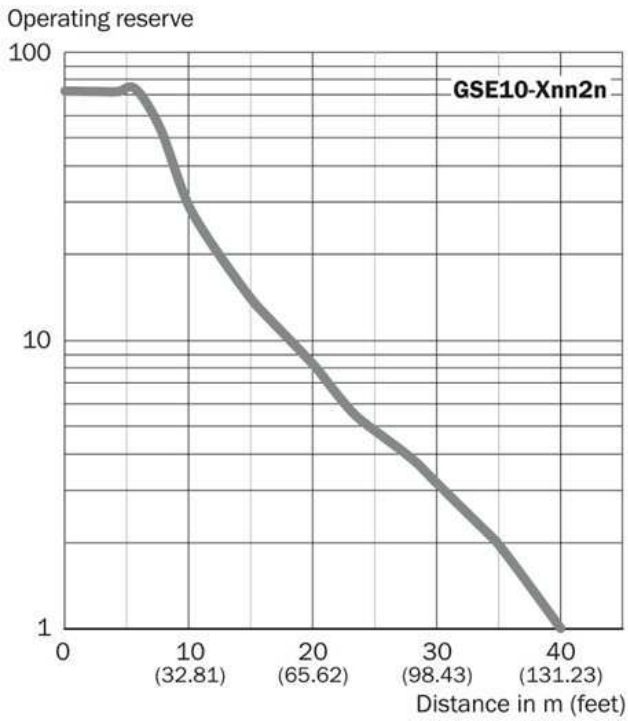

Scanning range

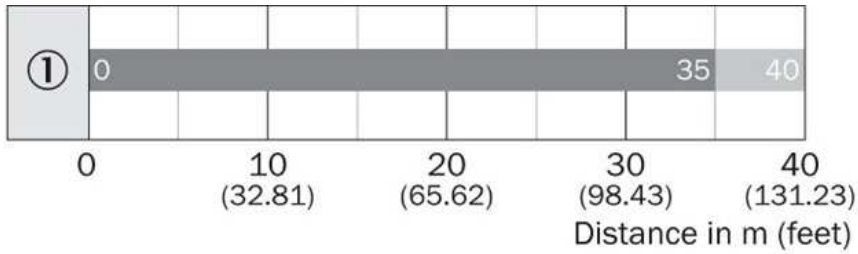

■ Sensing range

■ Sensing range max.

Light spot size

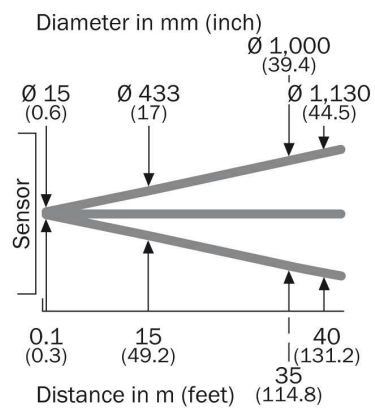

Australia

Phone +61 3 9457 0600
1800 33 48 02 – tollfree
E-Mail sales@sick.com.au

Belgium/Luxembourg

Phone +32 (0)2 466 55 66
E-Mail info@sick.be

Brasil

Phone +55 11 3215-4900
E-Mail marketing@sick.com.br

Canada

Phone +1 905 771 14 44
E-Mail information@sick.com

Česká republika

Phone +420 2 57 91 18 50
E-Mail sick@sick.cz

China

Phone +86 4000 121 000
E-Mail info.china@sick.net.cn
Phone +852-2153 6300
E-Mail ghk@sick.com.hk

Danmark

Phone +45 45 82 64 00
E-Mail sick@sick.dk

Deutschland

Phone +49 211 5301-301
E-Mail info@sick.de

España

Phone +34 93 480 31 00
E-Mail info@sick.es

France

Phone +33 1 64 62 35 00
E-Mail info@sick.fr

Great Britain

Phone +44 (0)1727 831121
E-Mail info@sick.co.uk

India

Phone +91-22-4033 8333
E-Mail info@sick-india.com

Israel

Phone +972-4-6881000
E-Mail info@sick-sensors.com

Italia

Phone +39 02 27 43 41
E-Mail info@sick.it

Japan

Phone +81 (0)3 5309 2112
E-Mail support@sick.jp

Magyarország

Phone +36 1 371 2680
E-Mail office@sick.hu

Nederland

Phone +31 (0)30 229 25 44
E-Mail info@sick.nl

Norge

Phone +47 67 81 50 00
E-Mail sick@sick.no

Österreich

Phone +43 (0)22 36 62 28 8-0
E-Mail office@sick.at

Polska

Phone +48 22 837 40 50
E-Mail info@sick.pl

România

Phone +40 356 171 120
E-Mail office@sick.ro

Russia

Phone +7-495-775-05-30
E-Mail info@sick.ru

Schweiz

Phone +41 41 619 29 39
E-Mail contact@sick.ch

Singapore

Phone +65 6744 3732
E-Mail sales.gsg@sick.com

Slovenija

Phone +386 (0)1-47 69 990
E-Mail office@sick.si

South Africa

Phone +27 11 472 3733
E-Mail info@sickautomation.co.za

South Korea

Phone +82 2 786 6321/4
E-Mail info@sickkorea.net

Suomi

Phone +358-9-25 15 800
E-Mail sick@sick.fi

Sverige

Phone +46 10 110 10 00
E-Mail info@sick.se

Taiwan

Phone +886 2 2375-6288
E-Mail sales@sick.com.tw

Türkiye

Phone +90 (216) 528 50 00
E-Mail info@sick.com.tr

United Arab Emirates

Phone +971 (0) 4 88 65 878
E-Mail info@sick.ae

USA/México

Phone +1(952) 941-6780
1 (800) 325-7425 – tollfree
E-Mail info@sickusa.com

More representatives and agencies
at www.sick.com