



Photoelectric sensors
G6, Photoelectric proximity sensor, energetic

GTE6-P3231



Model Name > [GTE6-P3231](#)
Part No. > [1068919](#)



Illustration may differ

At a glance

- PinPoint LED for a bright, precise light spot
- Durable metal threaded inserts
- SICK ASIC technology - the result of decades of experience in photoelectric sensors
- Large, user-friendly potentiometer
- Large, bright indicator LEDs
- IP 67 enclosure rating

Your benefits

- Easy alignment and precise object detection due to a highly visible PinPoint LED
- Quick and easy mounting and high durability due to threaded metal inserts
- SICK ASIC technology provides high performance, excellent reliability and crosstalk immunity
- Easy to adjust due to large, user-friendly potentiometers
- Easy to monitor due to large, bright indicator LEDs
- Easy installation with SICK accessories



Features

Sensor/detection principle:	Photoelectric proximity sensor, energetic
Dimensions (W x H x D):	12 mm x 31.5 mm x 21 mm
Housing design (light emission):	Rectangular
Sensing range max.:	≤ 900 mm
Sensing range:	≤ 760 mm
Type of light:	Visible red light
Light source:	PinPoint LED
Wave length:	650 nm
Adjustment:	Mechanical spindle, 5 turns
Light spot size (distance):	Ø 5 mm (150 mm)

Mechanics/electronics

Supply voltage:	10 V DC ... 30 V DC ¹⁾
Residual ripple:	± 10 % ²⁾
Power consumption:	≤ 30 mA ³⁾
Output type:	PNP
Switching mode:	Light/dark switching
Switching mode selector:	Selectable via light/dark selector

Output current I _{max} :	≤ 100 mA ⁴⁾
Response time:	1.25 ms ⁵⁾
Switching frequency:	500 Hz ⁶⁾
Electrical connection:	Connector M8, 3-pin
Circuit protection:::	A, B, D ^{7) 8) 9)}
Protection class:	III
Weight:	20 g
Polarisation filter:	-
Optics material:	PMMA
Enclosure rating:	IP 67
Ambient operating temperature:	-25 °C ... +55 °C ¹⁰⁾
Ambient storage temperature:	-40 °C ... +70 °C
UL File No.:	E348498
Signal voltage PNP HIGH/LOW:	Approx. V _S /≤ 3 V
Housing material:	ABS/PC

- 1) Limit values, operation in short-circuit protected network max. 8 A²⁾ May not exceed or fall short of V_S tolerances³⁾ Without load⁴⁾ At V_S > 24 V, I_A max = 50 mA
5) Signal transit time with resistive load⁶⁾ With light/dark ratio 1:1⁷⁾ A = V_S connections reverse-polarity protected⁸⁾ B = inputs and output reverse-polarity protected
9) D = outputs overcurrent and short-circuit protected¹⁰⁾ Temperature stability after adjustment +/-10°C

Dimensional drawing

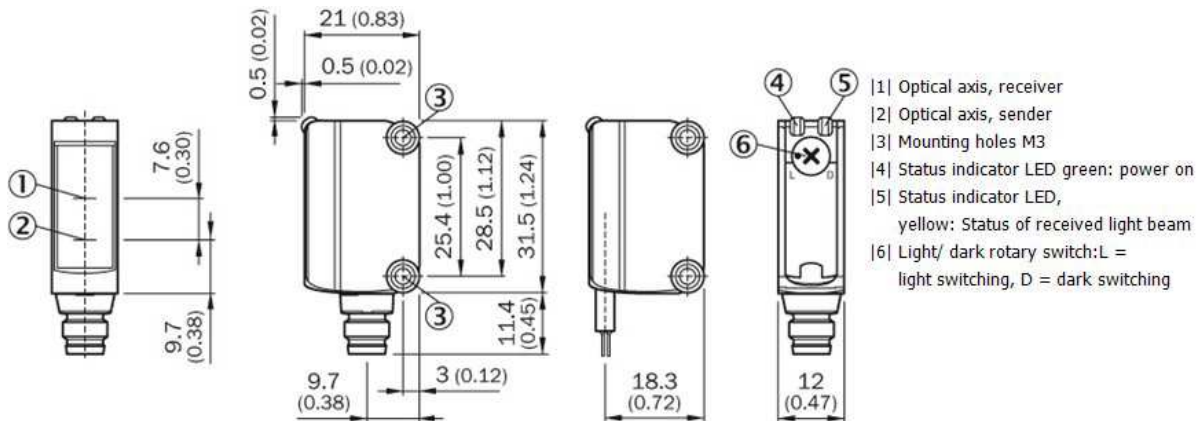

Adjustments possible

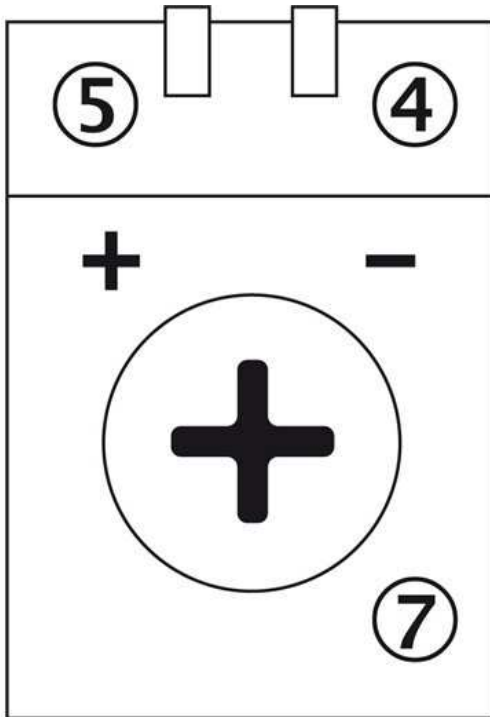

- |4| Status indicator LED green: power on
- |5| Status indicator LED,
yellow: Status of received light beam
- |7| Sensitivity adjustment: poti

Connection diagram

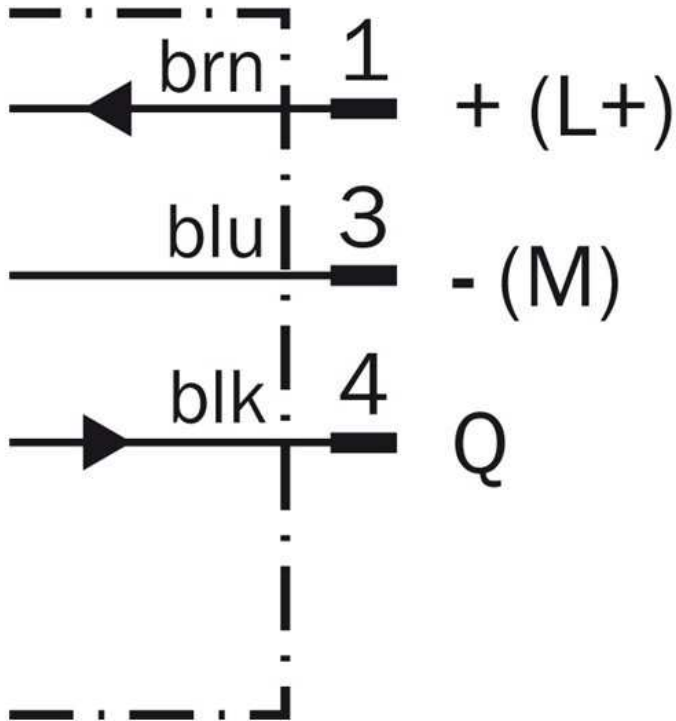

Characteristic curve

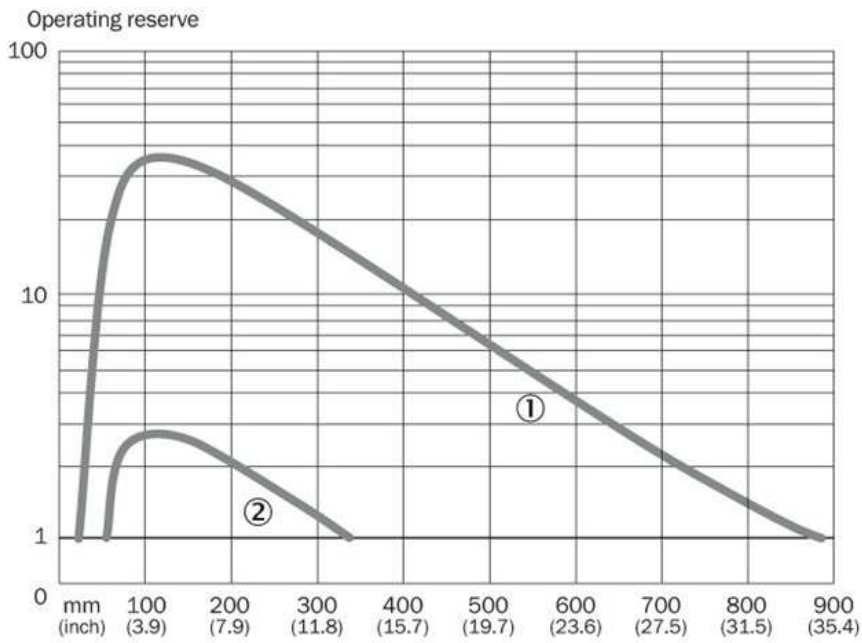

- |1| Sensing range on white, 90 % remission
- |2| Sensing range on black, 6.25 % remission

Sensing range diagram

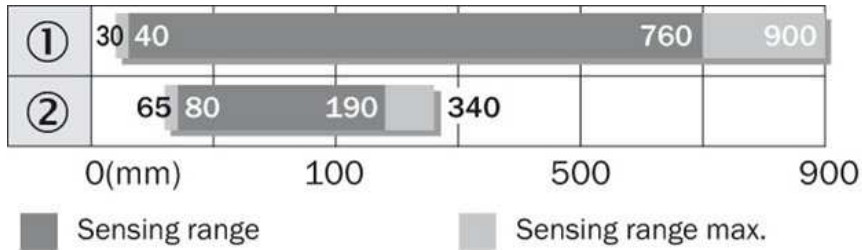

- |1| Sensing range on white, 90 % remission
- |2| Sensing range on black, 6.25 % remission

Connection type

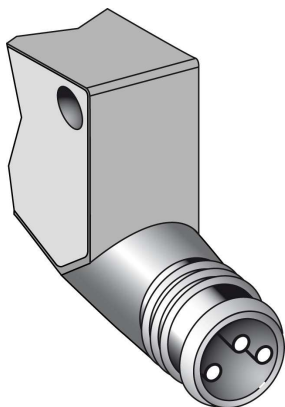

Light spot size

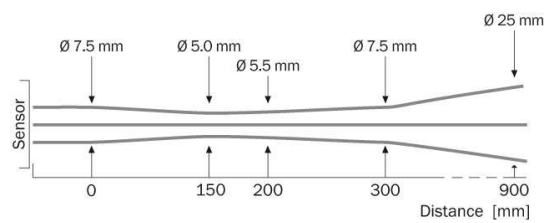

Australia

Phone +61 3 9457 0600
1800 33 48 02 – tollfree
E-Mail sales@sick.com.au

Belgium/Luxembourg

Phone +32 (0)2 466 55 66
E-Mail info@sick.be

Brasil

Phone +55 11 3215-4900
E-Mail marketing@sick.com.br

Canada

Phone +1 905 771 14 44
E-Mail information@sick.com

Česká republika

Phone +420 2 57 91 18 50
E-Mail sick@sick.cz

China

Phone +86 4000 121 000
E-Mail info.china@sick.net.cn
Phone +852-2153 6300
E-Mail ghk@sick.com.hk

Danmark

Phone +45 45 82 64 00
E-Mail sick@sick.dk

Deutschland

Phone +49 211 5301-301
E-Mail info@sick.de

España

Phone +34 93 480 31 00
E-Mail info@sick.es

France

Phone +33 1 64 62 35 00
E-Mail info@sick.fr

Great Britain

Phone +44 (0)1727 831121
E-Mail info@sick.co.uk

India

Phone +91-22-4033 8333
E-Mail info@sick-india.com

Israel

Phone +972-4-6881000
E-Mail info@sick-sensors.com

Italia

Phone +39 02 27 43 41
E-Mail info@sick.it

Japan

Phone +81 (0)3 5309 2112
E-Mail support@sick.jp

Magyarország

Phone +36 1 371 2680
E-Mail office@sick.hu

Nederland

Phone +31 (0)30 229 25 44
E-Mail info@sick.nl

Norge

Phone +47 67 81 50 00
E-Mail sick@sick.no

Österreich

Phone +43 (0)22 36 62 28 8-0
E-Mail office@sick.at

Polska

Phone +48 22 837 40 50
E-Mail info@sick.pl

România

Phone +40 356 171 120
E-Mail office@sick.ro

Russia

Phone +7-495-775-05-30
E-Mail info@sick.ru

Schweiz

Phone +41 41 619 29 39
E-Mail contact@sick.ch

Singapore

Phone +65 6744 3732
E-Mail sales.gsg@sick.com

Slovenija

Phone +386 (0)1-47 69 990
E-Mail office@sick.si

South Africa

Phone +27 11 472 3733
E-Mail info@sickautomation.co.za

South Korea

Phone +82 2 786 6321/4
E-Mail info@sickkorea.net

Suomi

Phone +358-9-25 15 800
E-Mail sick@sick.fi

Sverige

Phone +46 10 110 10 00
E-Mail info@sick.se

Taiwan

Phone +886 2 2375-6288
E-Mail sales@sick.com.tw

Türkiye

Phone +90 (216) 528 50 00
E-Mail info@sick.com.tr

United Arab Emirates

Phone +971 (0) 4 88 65 878
E-Mail info@sick.ae

USA/México

Phone +1(952) 941-6780
1 (800) 325-7425 – tollfree
E-Mail info@sickusa.com

More representatives and agencies
at www.sick.com