



## Incremental encoders DBS50 Core

DBS50E-S5EM01000



**Model Name** > **DBS50E-S5EM01000**  
**Part No.** > **1069388**



*Illustration may differ*

**At a glance**

- Connection with universal cable outlet
- Face mount flange with 8 mm solid shaft
- Face mount flange with 2 mounting hole patterns and servo groove
- "Compact housing diameter of 37 mm, flange diameter: 50 mm"
- Various electrical interfaces: TTL/RS-422, HTL/push pull and Open Collector NPN
- Available PPR from 10 up to 2,500
- Working temperature range: -20 °C ... +85 °C
- Enclosure rating: IP 65

**Your benefits**

- The universal cable outlet allows use in tight spaces and makes flexible cable routing possible
- Face mount flange with various mounting hole patterns for easy device replacement without changing the application
- Face mount flange with servo groove makes mounting with servo clamps possible
- The high flexibility of the encoders' mechanical interface and the available accessories make it possible to use one design in many applications
- The compact housing diameter saves valuable space



**Performance**

Error limits:	± 54 ° (/pulses per revolution)
Measuring step deviation:	± 18 ° /impulses per revolution
Measuring step:	90 ° /electronically/pulses
Initialization time:	< 3 ms
Pulses per revolution:	1,000
Duty cycle:	≤ 0.5 ± 5 %

**Mechanical data**

Mechanical interface:	Solid shaft, Face mount flange
Shaft diameter:	8 mm x 15.5 m
Start up torque:	0.9 Ncm (+20 °C)
Operating torque:	0.6 Ncm (+20 °C)
Maximum operating speed:	8,000 U/min <sup>1)</sup>
Moment of inertia of the rotor:	0.65 gcm <sup>2</sup>
Bearing lifetime:	2 x 10 <sup>9</sup> revolutions
Max. angular acceleration:	500,000 rad/s <sup>2</sup>

Permissible shaft loading radial/axial:	30 N (axial), 50 N (radial)
Shaft material:	Stainless steel
Operating speed:	6,000 /min <sup>2)</sup>
Flange material:	Aluminum
Housing material:	Aluminum
Material, cable:	PVC

<sup>1)</sup> No permanent operation. Decreasing signal quality. <sup>2)</sup> Self warming of 3.3 K per 1000 revolutions/min when applying note working temperature range

### Electrical data

---

Electrical interface:	7 V ... 30 V, HTL/Push pull
Electrical connection:	Cable, 8-wire, universal, 5 m
Maximum output frequency:	300 kHz
Reference signal, number:	1
Reference signal, position:	90 °, electronically, gated with A and B
Operating voltage range:	7 V ... 30 V
Load current max.:	30 mA
MTTFd: mean time to dangerous failure:	600 a (EN ISO 13849-1) <sup>1)</sup>
Power consumption max. without load:	0.5 W, Without load
Short-circuit protection of the outputs:	1 <sup>2)</sup>
Reverse polarity protection:	1

<sup>1)</sup> This product is a standard product and does not constitute a safety component as defined in the Machinery Directive.

Calculation based on nominal load of components, average ambient temperature 40°C, frequency of use 8760 h/a. All

electronic failures are considered hazardous. For more information, see document no. 8015532. <sup>2)</sup> The short-circuit rating is only given if Us and GND are connected correctly.

### Ambient data

---

EMC:	(according to EN 61000-6-2 and EN 61000-6-4 (class A))
Working temperature range:	-20 °C ... +85 °C
Storage temperature range:	-40 °C ... +100 °C, without package
Resistance to shocks:	100 g (EN 60068-2-27)
Resistance to vibration:	20 g, 10 Hz ... 2,000 Hz (EN 60068-2-6)
Enclosure rating:	IP 65
Permissible relative humidity:	90 % (condensation of the optical scanning not permitted)

## Dimensional drawing

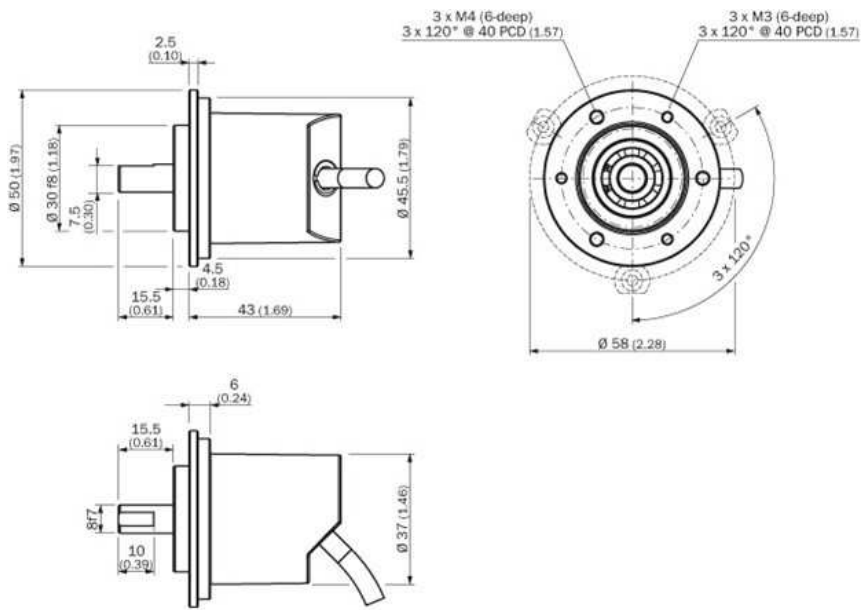

## PIN assignment

### 8-core cable

View of M12 device connector on cable



View of M23 device connector on cable



PIN, 8-pole in M12	PIN, 12-pole in M23	Color of wires	Signal OC	Signal TTL, HTL	Explanation
1	6	Brown	Not connected	$\bar{A}$	Signal line
2	5	White	A	A	Signal line
3	1	Black	Not connected	$\bar{B}$	Signal line
4	8	Pink	B	B	Signal line
5	4	Yellow	Not connected	$\bar{Z}$	Signal line
6	3	Lilac	Z	Z	Signal line
7	10	Blue	GND	GND	Ground connection of the encoder
8	12	Red	+U <sub>v</sub>	+U <sub>v</sub>	Supply voltage
-	9	-	Not connected	Not connected	Not connected
-	2	-	Not connected	Not connected	Not connected
-	11	-	Not connected	Not connected	Not connected
-	7	-	Not connected	Not connected	Not connected
Screen	Screen	Screen	Screen	Screen	Screen connected to encoder housing

**Australia**

Phone +61 3 9457 0600  
1800 33 48 02 – tollfree  
E-Mail sales@sick.com.au

**Belgium/Luxembourg**

Phone +32 (0)2 466 55 66  
E-Mail info@sick.be

**Brasil**

Phone +55 11 3215-4900  
E-Mail marketing@sick.com.br

**Canada**

Phone +1 905 771 14 44  
E-Mail information@sick.com

**Česká republika**

Phone +420 2 57 91 18 50  
E-Mail sick@sick.cz

**China**

Phone +86 4000 121 000  
E-Mail info.china@sick.net.cn  
Phone +852-2153 6300  
E-Mail ghk@sick.com.hk

**Danmark**

Phone +45 45 82 64 00  
E-Mail sick@sick.dk

**Deutschland**

Phone +49 211 5301-301  
E-Mail info@sick.de

**España**

Phone +34 93 480 31 00  
E-Mail info@sick.es

**France**

Phone +33 1 64 62 35 00  
E-Mail info@sick.fr

**Great Britain**

Phone +44 (0)1727 831121  
E-Mail info@sick.co.uk

**India**

Phone +91-22-4033 8333  
E-Mail info@sick-india.com

**Israel**

Phone +972-4-6881000  
E-Mail info@sick-sensors.com

**Italia**

Phone +39 02 27 43 41  
E-Mail info@sick.it

**Japan**

Phone +81 (0)3 5309 2112  
E-Mail support@sick.jp

**Magyarország**

Phone +36 1 371 2680  
E-Mail office@sick.hu

**Nederland**

Phone +31 (0)30 229 25 44  
E-Mail info@sick.nl

**Norge**

Phone +47 67 81 50 00  
E-Mail sick@sick.no

**Österreich**

Phone +43 (0)22 36 62 28 8-0  
E-Mail office@sick.at

**Polska**

Phone +48 22 837 40 50  
E-Mail info@sick.pl

**România**

Phone +40 356 171 120  
E-Mail office@sick.ro

**Russia**

Phone +7-495-775-05-30  
E-Mail info@sick.ru

**Schweiz**

Phone +41 41 619 29 39  
E-Mail contact@sick.ch

**Singapore**

Phone +65 6744 3732  
E-Mail sales.gsg@sick.com

**Slovenija**

Phone +386 (0)1-47 69 990  
E-Mail office@sick.si

**South Africa**

Phone +27 11 472 3733  
E-Mail info@sickautomation.co.za

**South Korea**

Phone +82 2 786 6321/4  
E-Mail info@sickkorea.net

**Suomi**

Phone +358-9-25 15 800  
E-Mail sick@sick.fi

**Sverige**

Phone +46 10 110 10 00  
E-Mail info@sick.se

**Taiwan**

Phone +886 2 2375-6288  
E-Mail sales@sick.com.tw

**Türkiye**

Phone +90 (216) 528 50 00  
E-Mail info@sick.com.tr

**United Arab Emirates**

Phone +971 (0) 4 88 65 878  
E-Mail info@sick.ae

**USA/México**

Phone +1(952) 941-6780  
1 (800) 325-7425 – tollfree  
E-Mail info@sickusa.com

More representatives and agencies  
at [www.sick.com](http://www.sick.com)