



Switching automation light grids SLG, SGS

SGS4-F140P7PS2T01



Model Name > [SGS4-F140P7PS2T01](#)
Part No. > [1210585](#)



At a glance

- Variable monitoring lengths from 120 mm up to 1,400 mm (in 160 mm increments)
- Maximum range 10 m
- Response time 18 ms
- 25 mm or 45 mm detection resolution with 40 mm or 80 mm beam spacing possible
- Order-picking with extra-bright job LEDs on the sender and receiver sides
- IP 65 protection for various environmental conditions
- Highly immune to sunlight at 150,000 lx

Your benefits

- Small, slim and sleek design enables easy integration into applications
- Capacitive teach-in button and LEDs make commissioning easier for complex solutions
- Slim and flat models offer flexible mounting options
- User-defined factory preset configuration or flexible configuration with teach-in button
- Optical synchronization eliminates the need to lay cables, saving time
- Stealth detection in public places - at only 8 mm x 25 mm, it fits just about anywhere and can be imbedded inside walls, doors, conveyors, and machines, reducing damage
- Auto-teach and auto-muting enable Plug & Play. And, an alignment aid and "Click & Go" provide faster installation.



Features

Technology:	Sender/receiver
Task:	Switching light grid
Minimum detectable object (MDO) ¹⁾ :	Cross beam, 25 mm
Beam separation:	40 mm
Number of beams:	36

Detection height:	1,400 mm
Optical light exit:	Flat
Configuration:	Teach button with configuration software
Cross beam/parallel beam:	Cross beam active
Output 1:	Output 1 active, if light beam interrupted
Automatic teach:	Automatic teach inactive
Alignment aid:	Without alignment aid
Muting function:	Muting function inactive

¹⁾ 25 mm MDO limited detection area

Performance

Maximum range:	10 m ¹⁾
Minimum range:	Multiple scan: ≥ 0.3 mm ²⁾
Working range:	7 m
Response time:	Multiple scan 57 ms

¹⁾ No reserve for environmental issue and deterioration of the diode ²⁾ Aperture $\pm 10^\circ$

Interfaces

Output type:	1 x PNP
Electrical connection:	Short cable with connector M8, 4-pin
Inputs:	Teach input

Mechanics/electronics

Wave length:	IR 950 nm
Supply voltage V_s ¹⁾ :	DC 24 V, ± 20 %
Power consumption sender ²⁾ :	256 mA
Power consumption receiver ^{3), 4)} :	70 mA
Residual ripple:	< 5 Vpp
Output current $I_{max.}$:	100 mA
Output load capacitive:	100 nF
Output load inductive:	1 H
Initialization time:	1 s
Dimensions (W x H x D):	25 mm x 1,472.4 mm x 8 mm
Housing material:	PMMA
Indication:	LED
Enclosure rating:	IP 65
Circuit protection:	Output Q short-circuit protected Interference suppression VS connections reverse-polarity protected
Weight:	180 g
Switching frequency:	500 kHz
Aluminum stabilizer:	With stabilizer
Synchronization:	Optical

¹⁾ Limit values ^{2) 3) 4)} Without load

Ambient data

Protection class:	III
EMC:	EN 60947-5-2

Ambient temperature:

Operation: -25 ... +55 °C

Storage: -25 ... +70 °C

Vibration resistance:

5 g, 10 Hz ... 55 Hz (IEC 68-2-6)

Shock load:

10 g/DIN EN 60068-2-29/16 ms

Ambient light immunity:

Direct: $\geq 100,000$ lx, Indirect: $\geq 150,000$ lx ¹⁾

¹⁾ Sunlight

Dimensional drawing

Flat, with stabilizer

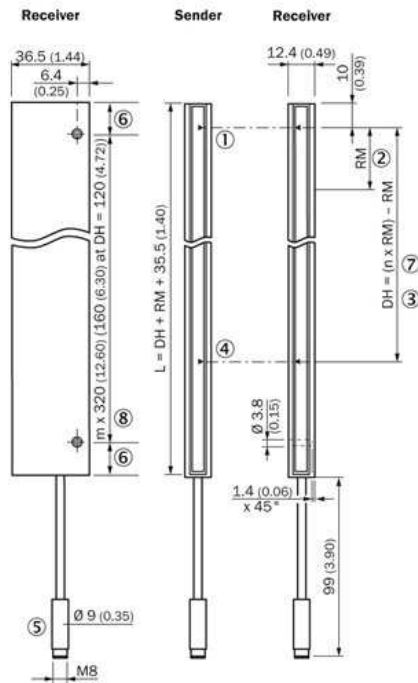

- |1| Last beam
- |2| Beam separation RM
- |3| DH - Detection height (n x 40 mm) - RM
- |4| First beam
- |5| Connection
- |6| Same distance
- |7| n = beam
- |8| m = mounting hole

Receiver, LED indication



Connection type and diagram

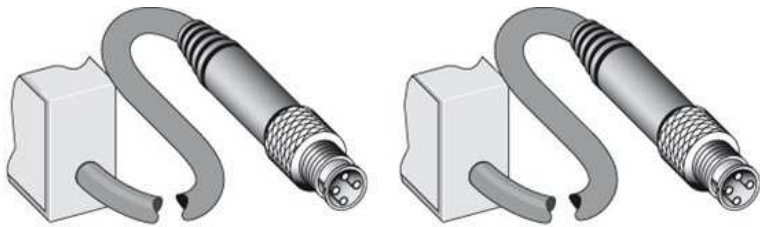

Sender



Receiver PNP/NPN



Receiver 2 x PNP/2 x NPN



Special functions

Image Unavailable
f:\Saqqara\im0056644.jpg

Setting the switching threshold

Image Unavailable
f:\Saqqara\im0056646.jpg

Configuration mode

Image Unavailable
f:\Saqqara\im0056648.jpg

Australia

Phone +61 3 9457 0600
1800 33 48 02 – tollfree
E-Mail sales@sick.com.au

Belgium/Luxembourg

Phone +32 (0)2 466 55 66
E-Mail info@sick.be

Brasil

Phone +55 11 3215-4900
E-Mail marketing@sick.com.br

Canada

Phone +1 905 771 14 44
E-Mail information@sick.com

Česká republika

Phone +420 2 57 91 18 50
E-Mail sick@sick.cz

China

Phone +86 4000 121 000
E-Mail info.china@sick.net.cn
Phone +852-2153 6300
E-Mail ghk@sick.com.hk

Danmark

Phone +45 45 82 64 00
E-Mail sick@sick.dk

Deutschland

Phone +49 211 5301-301
E-Mail info@sick.de

España

Phone +34 93 480 31 00
E-Mail info@sick.es

France

Phone +33 1 64 62 35 00
E-Mail info@sick.fr

Great Britain

Phone +44 (0)1727 831121
E-Mail info@sick.co.uk

India

Phone +91-22-4033 8333
E-Mail info@sick-india.com

Israel

Phone +972-4-6881000
E-Mail info@sick-sensors.com

Italia

Phone +39 02 27 43 41
E-Mail info@sick.it

Japan

Phone +81 (0)3 5309 2112
E-Mail support@sick.jp

Magyarország

Phone +36 1 371 2680
E-Mail office@sick.hu

Nederland

Phone +31 (0)30 229 25 44
E-Mail info@sick.nl

Norge

Phone +47 67 81 50 00
E-Mail sick@sick.no

Österreich

Phone +43 (0)22 36 62 28 8-0
E-Mail office@sick.at

Polska

Phone +48 22 837 40 50
E-Mail info@sick.pl

România

Phone +40 356 171 120
E-Mail office@sick.ro

Russia

Phone +7-495-775-05-30
E-Mail info@sick.ru

Schweiz

Phone +41 41 619 29 39
E-Mail contact@sick.ch

Singapore

Phone +65 6744 3732
E-Mail sales.gsg@sick.com

Slovenija

Phone +386 (0)1-47 69 990
E-Mail office@sick.si

South Africa

Phone +27 11 472 3733
E-Mail info@sickautomation.co.za

South Korea

Phone +82 2 786 6321/4
E-Mail info@sickkorea.net

Suomi

Phone +358-9-25 15 800
E-Mail sick@sick.fi

Sverige

Phone +46 10 110 10 00
E-Mail info@sick.se

Taiwan

Phone +886 2 2375-6288
E-Mail sales@sick.com.tw

Türkiye

Phone +90 (216) 528 50 00
E-Mail info@sick.com.tr

United Arab Emirates

Phone +971 (0) 4 88 65 878
E-Mail info@sick.ae

USA/México

Phone +1(952) 941-6780
1 (800) 325-7425 – tollfree
E-Mail info@sickusa.com

More representatives and agencies
at www.sick.com