



Measuring automation light grids 4 x Q (IO-Link) , MLG-2 Pro

MLG05A-2545R10501



Model Name > [MLG05A-2545R10501](#)
Part No. > [1214026](#)



At a glance

- High-resolution light grid: Available with beam separation of 2.5 mm (coming soon), 5 mm, 10 mm, 25 mm, and 50 mm
- "High-speed scan" function with triple scanning speed
- "Transparent mode" function for detecting transparent materials
- Switchable to high-resolution evaluation
- Data compression: Run length coding
- Ethernet-based interfaces, including PROFINET, PROFIBUS, and CANopen (coming soon)
- Cloning function via IO-Link or clone plug
- SOPAS configuration software

Your benefits

- "High-speed scan" function offers short response times for safely detecting objects traveling at high speeds
- Modular concept offers the perfect solution every time from a single source
- "High measurement accuracy" function for detecting small objects reliably
- "Transparent mode" function for reliably detecting and measuring transparent objects
- Integrated bus interfaces and accompanying functional modules reduce the time and effort involved in the commissioning process
- SOPAS configuration software with menu-driven wizard saves time during the configuration process
- Simple maintenance without the need for specialist staff thanks to the cloning function with IO-Link
- High reliability due to ambient light immunity



Features

Technology:	Sender/receiver
Minimum detectable object (MDO) ¹⁾ ; ²⁾ ; ³⁾ :	5 mm 9 mm
Beam separation:	5 mm
Number of beams:	510
Detection height:	2,545 mm
Version:	Pro
Software features:	Q1: presence detection, Teach-in, Presence detection, Presence detection, Standard mode

¹⁾ MDO min. detectable object at high measurement accuracy ²⁾ MDO min. detectable object at standard measurement accuracy ³⁾ Dependent from beam separation without cross beam adjustment

Performance

Maximum range ¹⁾ :	7 m
Minimum range:	≥0 mm
Response time ²⁾ , ³⁾ :	40.6 ms
Working range:	5 m

¹⁾ No reserve for environmental issue and deterioration of the diode ²⁾ Without high speed ³⁾ With resistive load

Interfaces

Data interface:	4 x Q (IO-Link)
Electrical connection:	Male connector M12, 8-pin
IO-Link:	✓

Mechanics/electronics

Wave length:	850 nm
Supply voltage Vs ¹⁾ :	DC 18 V ... 30 V
Power consumption sender ²⁾ :	80.5 mA
Power consumption receiver ³⁾ :	222 mA
Residual ripple:	< 5 Vpp
Output current I _{max} ·:	100 mA
Output load capacitive:	100 nF
Output load inductive:	1 H
Initialization time:	< 1 s
Dimensions (W x H x D):	34 mm x 2,623.3 mm x 30.6 mm
Housing material:	Aluminum
Indication:	LED
Enclosure rating:	IP 65, IP 67
Circuit protection:	Output Q short-circuit protected, Interference suppression, VS connections reverse-polarity protected
Weight:	5.347 kg
Front screen:	PMMA
Option:	Nonexistent

¹⁾ Without load ²⁾ ³⁾ Without load with 24 V

Ambient data

Protection class:	III
EMC:	EN 60947-5-2
Ambient temperature:	Operation: -30 ... +55 °C, Storage: -40 ... +70 °C
Vibration resistance:	5 g, 10 Hz ... 55 Hz (EN 60 068-2-64)
Shock load:	15 g/DIN EN 60 068-2-27/16 ms
Ambient light immunity::	Direct: 12,500 ... 150,000 lx, Indirect: ≥50,000 lx ¹⁾ ²⁾

¹⁾ Outdoor mode ²⁾ Light resistance indirect

Dimensional drawing

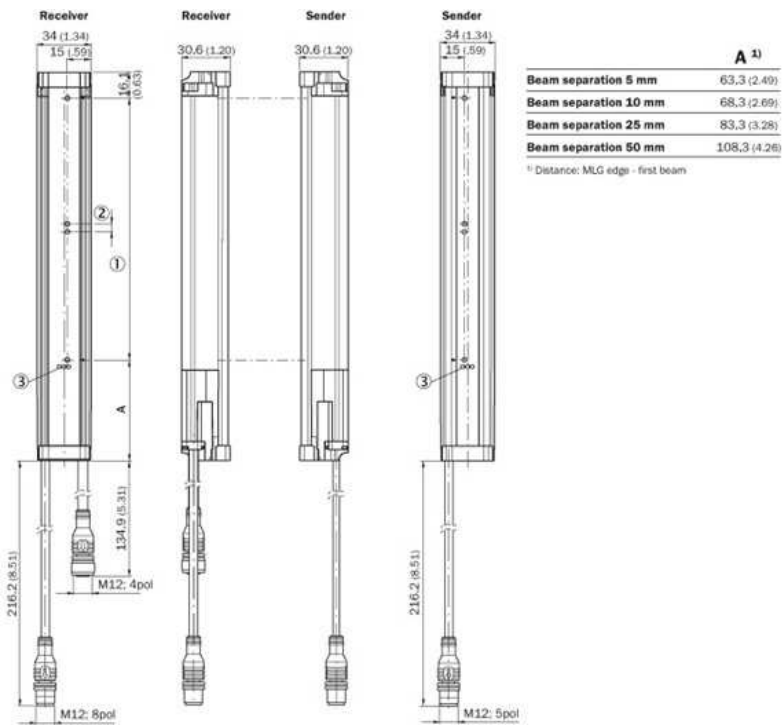

- [1] Detection height (see optical performance)
- [2] Beam separation RM
- [3] Status indicator: LEDs green, yellow, red

Adjustments

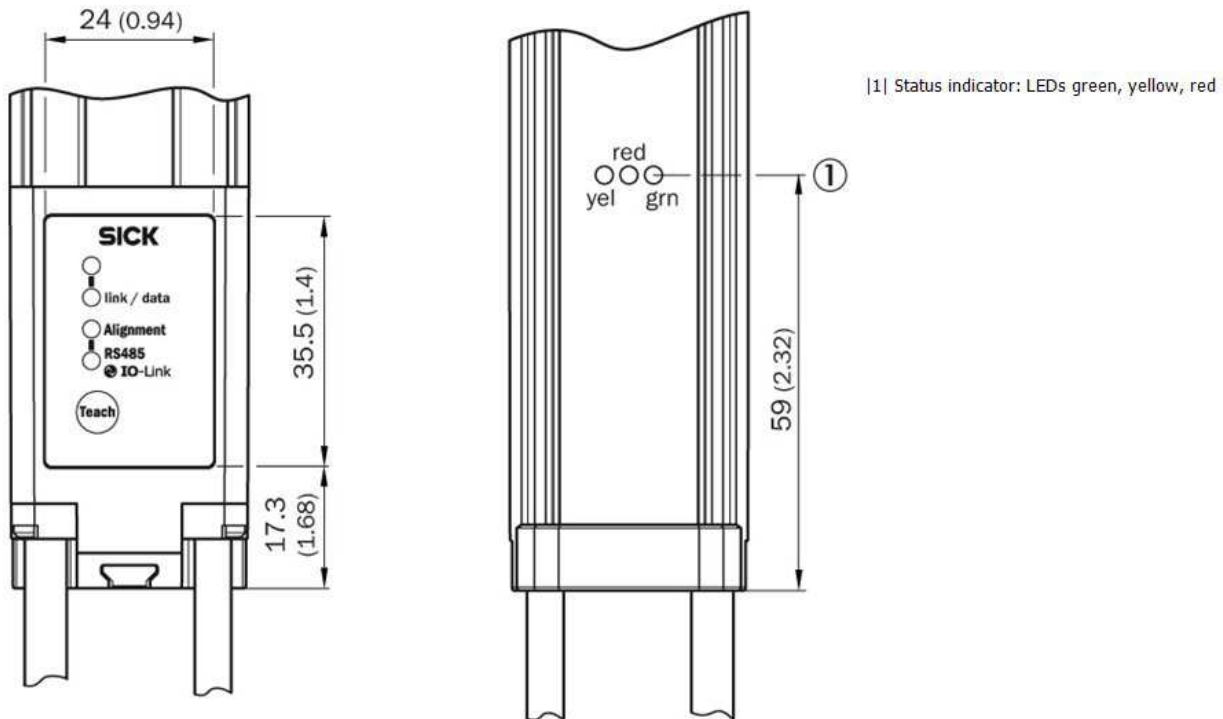

Anschlussart und -schema

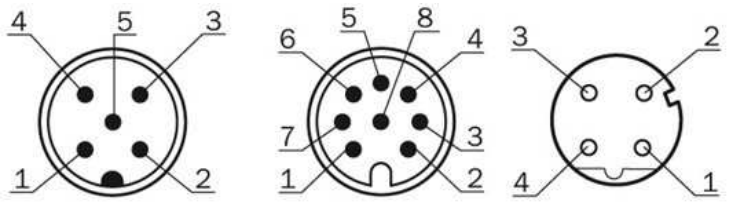

Sender

Receiver

Receiver Ethernet

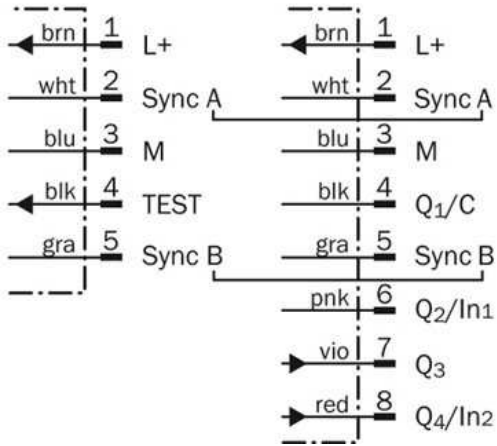

Australia

Phone +61 3 9457 0600
1800 33 48 02 – tollfree
E-Mail sales@sick.com.au

Belgium/Luxembourg

Phone +32 (0)2 466 55 66
E-Mail info@sick.be

Brasil

Phone +55 11 3215-4900
E-Mail marketing@sick.com.br

Canada

Phone +1 905 771 14 44
E-Mail information@sick.com

Česká republika

Phone +420 2 57 91 18 50
E-Mail sick@sick.cz

China

Phone +86 4000 121 000
E-Mail info.china@sick.net.cn
Phone +852-2153 6300
E-Mail ghk@sick.com.hk

Danmark

Phone +45 45 82 64 00
E-Mail sick@sick.dk

Deutschland

Phone +49 211 5301-301
E-Mail info@sick.de

España

Phone +34 93 480 31 00
E-Mail info@sick.es

France

Phone +33 1 64 62 35 00
E-Mail info@sick.fr

Great Britain

Phone +44 (0)1727 831121
E-Mail info@sick.co.uk

India

Phone +91-22-4033 8333
E-Mail info@sick-india.com

Israel

Phone +972-4-6881000
E-Mail info@sick-sensors.com

Italia

Phone +39 02 27 43 41
E-Mail info@sick.it

Japan

Phone +81 (0)3 5309 2112
E-Mail support@sick.jp

Magyarország

Phone +36 1 371 2680
E-Mail office@sick.hu

Nederland

Phone +31 (0)30 229 25 44
E-Mail info@sick.nl

Norge

Phone +47 67 81 50 00
E-Mail sick@sick.no

Österreich

Phone +43 (0)22 36 62 28 8-0
E-Mail office@sick.at

Polska

Phone +48 22 837 40 50
E-Mail info@sick.pl

România

Phone +40 356 171 120
E-Mail office@sick.ro

Russia

Phone +7-495-775-05-30
E-Mail info@sick.ru

Schweiz

Phone +41 41 619 29 39
E-Mail contact@sick.ch

Singapore

Phone +65 6744 3732
E-Mail sales.gsg@sick.com

Slovenija

Phone +386 (0)1-47 69 990
E-Mail office@sick.si

South Africa

Phone +27 11 472 3733
E-Mail info@sickautomation.co.za

South Korea

Phone +82 2 786 6321/4
E-Mail info@sickkorea.net

Suomi

Phone +358-9-25 15 800
E-Mail sick@sick.fi

Sverige

Phone +46 10 110 10 00
E-Mail info@sick.se

Taiwan

Phone +886 2 2375-6288
E-Mail sales@sick.com.tw

Türkiye

Phone +90 (216) 528 50 00
E-Mail info@sick.com.tr

United Arab Emirates

Phone +971 (0) 4 88 65 878
E-Mail info@sick.ae

USA/México

Phone +1(952) 941-6780
1 (800) 325-7425 – tollfree
E-Mail info@sickusa.com

More representatives and agencies
at www.sick.com