



Mounting systems
Device protection (mechanical) / Protective
housings/pipes

IPG67-06705111



Model Name > [IPG67-06705111](#)
Part No. > [2070395](#)



At a glance

- Protection category: IP 67
- Operating range of light grids: up to 9m
- Resistant to temperatures from -20°C up to +55°C
- End caps in aluminium or stainless steel
- Customer can easily screw the protective pipe together
- Can be ordered subsequently as accessory

Your benefits

- Costs can be saved due to the extended service life of the light grids
- Higher production quality because of reduced risk of dirt
- Easy commissioning and retrofitting
- Costs can be saved because no additional sensors need to be mounted
- Makes automation in dusty and dirty conditions possible



Technical data

Accessory group:	Device protection (mechanical)
Accessory family:	Protective housings and protective pipes
Material:	ABS-plastic (support holder), Aluminum (end caps, spacer), PMMA (protective pipe), Polyamid (cable screw connection)
Description:	Protection class: IP 67 Ambient temperature from ... to: -20 °C ... +55 °C Air humidity from ... to: 15 % ... 95 %, non-condensing Vibration resistance: 5 g (10 Hz ... 55 Hz) (IEC 60068-2-6) Shock resistance: 10 g, 16 ms (IEC 60068-2-29)
Suitable for:	Protective pipe for light grids MLG, XLG and ELG
Dimensions (W x H x L):	50 mm x 50 mm x 670 mm

Dimensional drawing

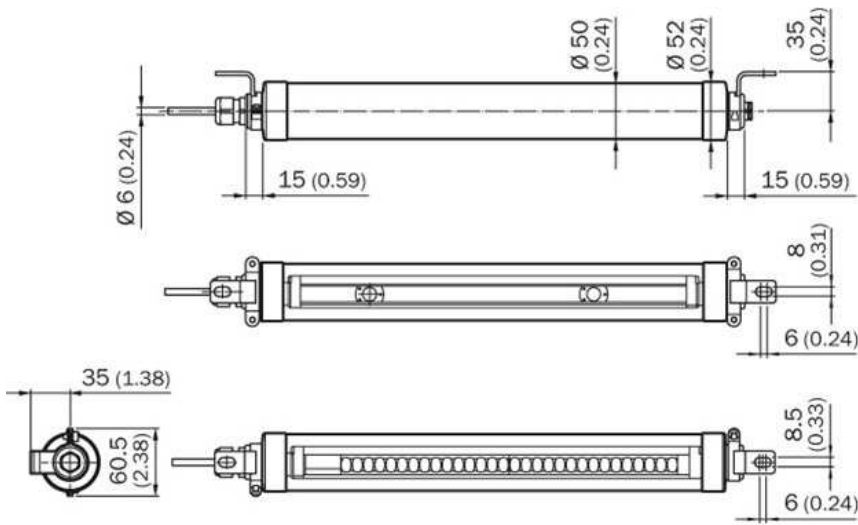

Australia

Phone +61 3 9457 0600
1800 33 48 02 – tollfree
E-Mail sales@sick.com.au

Belgium/Luxembourg

Phone +32 (0)2 466 55 66
E-Mail info@sick.be

Brasil

Phone +55 11 3215-4900
E-Mail marketing@sick.com.br

Canada

Phone +1 905 771 14 44
E-Mail information@sick.com

Česká republika

Phone +420 2 57 91 18 50
E-Mail sick@sick.cz

China

Phone +86 4000 121 000
E-Mail info.china@sick.net.cn
Phone +852-2153 6300
E-Mail ghk@sick.com.hk

Danmark

Phone +45 45 82 64 00
E-Mail sick@sick.dk

Deutschland

Phone +49 211 5301-301
E-Mail info@sick.de

España

Phone +34 93 480 31 00
E-Mail info@sick.es

France

Phone +33 1 64 62 35 00
E-Mail info@sick.fr

Great Britain

Phone +44 (0)1727 831121
E-Mail info@sick.co.uk

India

Phone +91-22-4033 8333
E-Mail info@sick-india.com

Israel

Phone +972-4-6881000
E-Mail info@sick-sensors.com

Italia

Phone +39 02 27 43 41
E-Mail info@sick.it

Japan

Phone +81 (0)3 5309 2112
E-Mail support@sick.jp

Magyarország

Phone +36 1 371 2680
E-Mail office@sick.hu

Nederland

Phone +31 (0)30 229 25 44
E-Mail info@sick.nl

Norge

Phone +47 67 81 50 00
E-Mail sick@sick.no

Österreich

Phone +43 (0)22 36 62 28 8-0
E-Mail office@sick.at

Polska

Phone +48 22 837 40 50
E-Mail info@sick.pl

România

Phone +40 356 171 120
E-Mail office@sick.ro

Russia

Phone +7-495-775-05-30
E-Mail info@sick.ru

Schweiz

Phone +41 41 619 29 39
E-Mail contact@sick.ch

Singapore

Phone +65 6744 3732
E-Mail sales.gsg@sick.com

Slovenija

Phone +386 (0)1-47 69 990
E-Mail office@sick.si

South Africa

Phone +27 11 472 3733
E-Mail info@sickautomation.co.za

South Korea

Phone +82 2 786 6321/4
E-Mail info@sickkorea.net

Suomi

Phone +358-9-25 15 800
E-Mail sick@sick.fi

Sverige

Phone +46 10 110 10 00
E-Mail info@sick.se

Taiwan

Phone +886 2 2375-6288
E-Mail sales@sick.com.tw

Türkiye

Phone +90 (216) 528 50 00
E-Mail info@sick.com.tr

United Arab Emirates

Phone +971 (0) 4 88 65 878
E-Mail info@sick.ae

USA/México

Phone +1(952) 941-6780
1 (800) 325-7425 – tollfree
E-Mail info@sickusa.com

More representatives and agencies
at www.sick.com