



fibers  
LL3, Fibers, through-beam system

LL3-TE03



**Model Name** > [LL3-TE03](#)  
**Part No.** > [5325908](#)



**At a glance**

- Easy mounting
- Flush mounting in a single slot
- Background effects are minimized

**Your benefits**

- Very large selection of fiber-optic cables with plastic and glass fibers, giving users more application flexibility
- Resistant to damage caused by mechanical and chemical stress, as well as high temperatures
- Standard and customer-specific types
- Simple installation saves time
- For detection of objects, surfaces, leading edges, and fluid levels

**Features**

For fiber-optic sensor:	WLL160(T), WLL170-2/WLL170T-2, WLL180T, WLL190T-2
Device type:	Fibers
Jacket material:	PE
Core material:	PMMA
Sleeve material:	PC
Diameter, connection:	1.3 mm
Mounting sleeve dimension:	7 x 14 x 3,5 mm
Bend radius, fibre-optic cable:	1 mm
Heat resistance:	60 °C
Ambient temperature operation:	-40 °C ... 60 °C
Minimal object diameter:	0.08 mm <sup>1)</sup>
Core structure:	151 x 0.075 mm
Fiber-optic cable cuttable <sup>2)</sup> :	✓
Thread sleeve:	-
Sleeve:	-
90° offset:	-
Flat housing:	✓
High flexible:	✓
Long end sleeve:	-
Array:	-
High temperature:	-
Oil/chemical resistant:	-
Lcd/clear material/semiconductor:	-
Vacuum:	-

Robotics:	-
Retro-reflective:	-
Liquid level:	-
Category fiber-optic cables:	Flat type, Flexible fiber-optic cable
Fiber length:	2,000 mm

1) Minimum detectable object was determined at optimal measuring distance and optimal setting 2) FC fiber optic cable cutter included in delivery

### Sensing range with WLL180T

Operating mode 16 $\mu$ s:	190 mm
Operating mode 70 $\mu$ s:	580 mm
Operating mode 250 $\mu$ s:	980 mm
Operating mode 2 ms:	1,970 mm
Operating mode 8 ms:	2,100 mm

### Sensing range with WLL170-2

Redlight 250 $\mu$ s:	500 mm
Greenlight 250 $\mu$ s:	200 mm
Highspeed 50 $\mu$ s:	250 mm

### Dimensional drawing

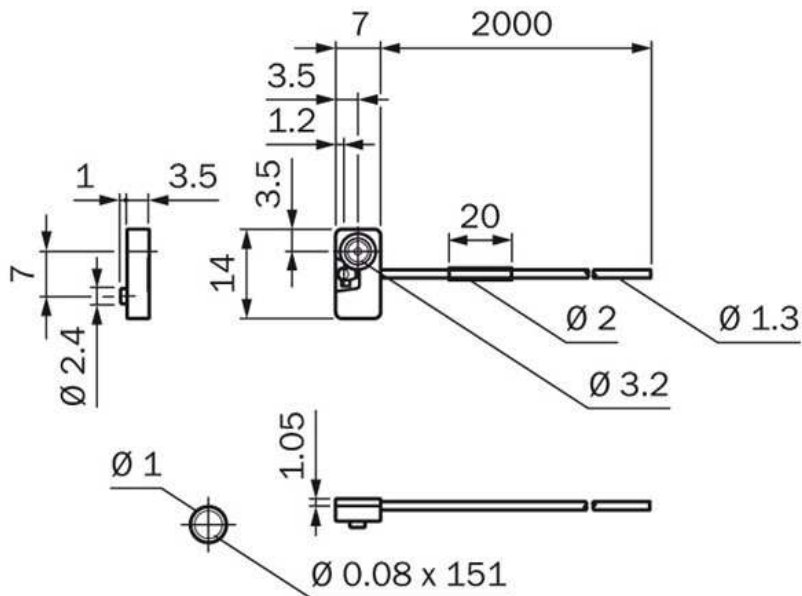

All dimensions in mm

**Australia**

Phone +61 3 9457 0600  
1800 33 48 02 – tollfree  
E-Mail sales@sick.com.au

**Belgium/Luxembourg**

Phone +32 (0)2 466 55 66  
E-Mail info@sick.be

**Brasil**

Phone +55 11 3215-4900  
E-Mail marketing@sick.com.br

**Canada**

Phone +1 905 771 14 44  
E-Mail information@sick.com

**Česká republika**

Phone +420 2 57 91 18 50  
E-Mail sick@sick.cz

**China**

Phone +86 4000 121 000  
E-Mail info.china@sick.net.cn  
Phone +852-2153 6300  
E-Mail ghk@sick.com.hk

**Danmark**

Phone +45 45 82 64 00  
E-Mail sick@sick.dk

**Deutschland**

Phone +49 211 5301-301  
E-Mail info@sick.de

**España**

Phone +34 93 480 31 00  
E-Mail info@sick.es

**France**

Phone +33 1 64 62 35 00  
E-Mail info@sick.fr

**Great Britain**

Phone +44 (0)1727 831121  
E-Mail info@sick.co.uk

**India**

Phone +91-22-4033 8333  
E-Mail info@sick-india.com

**Israel**

Phone +972-4-6881000  
E-Mail info@sick-sensors.com

**Italia**

Phone +39 02 27 43 41  
E-Mail info@sick.it

**Japan**

Phone +81 (0)3 5309 2112  
E-Mail support@sick.jp

**Magyarország**

Phone +36 1 371 2680  
E-Mail office@sick.hu

**Nederland**

Phone +31 (0)30 229 25 44  
E-Mail info@sick.nl

**Norge**

Phone +47 67 81 50 00  
E-Mail sick@sick.no

**Österreich**

Phone +43 (0)22 36 62 28 8-0  
E-Mail office@sick.at

**Polska**

Phone +48 22 837 40 50  
E-Mail info@sick.pl

**România**

Phone +40 356 171 120  
E-Mail office@sick.ro

**Russia**

Phone +7-495-775-05-30  
E-Mail info@sick.ru

**Schweiz**

Phone +41 41 619 29 39  
E-Mail contact@sick.ch

**Singapore**

Phone +65 6744 3732  
E-Mail sales.gsg@sick.com

**Slovenija**

Phone +386 (0)1-47 69 990  
E-Mail office@sick.si

**South Africa**

Phone +27 11 472 3733  
E-Mail info@sickautomation.co.za

**South Korea**

Phone +82 2 786 6321/4  
E-Mail info@sickkorea.net

**Suomi**

Phone +358-9-25 15 800  
E-Mail sick@sick.fi

**Sverige**

Phone +46 10 110 10 00  
E-Mail info@sick.se

**Taiwan**

Phone +886 2 2375-6288  
E-Mail sales@sick.com.tw

**Türkiye**

Phone +90 (216) 528 50 00  
E-Mail info@sick.com.tr

**United Arab Emirates**

Phone +971 (0) 4 88 65 878  
E-Mail info@sick.ae

**USA/México**

Phone +1(952) 941-6780  
1 (800) 325-7425 – tollfree  
E-Mail info@sickusa.com

More representatives and agencies  
at [www.sick.com](http://www.sick.com)