



Photoelectric sensors
V18, Photoelectric proximity sensor, energetic

VTE18-3F8612



Model Name > [VTE18-3F8612](#)
Part No. > [6013168](#)



Illustration may differ

At a glance

- Cylindrical M18 housing
- Three sensing distances of 200 mm, 400 mm or 800 mm
- 3- or 4-wire
- Straight or right-angle housing
- Metal or plastic housing

Your benefits

- Simple, standardized design ensures easy mounting, alignment and replacement
- Compact, space-saving design easily fits in tight application spaces



Features

Sensor/detection principle:	Photoelectric proximity sensor, energetic
Housing design (light emission):	Cylindrical, straight, straight
Housing length:	63.6 mm
Thread diameter (housing):	M18 x 1
Optical axis:	axial
Sensing range max.:	10 mm ... 800 mm ¹⁾
Sensing range:	10 mm ... 700 mm
Type of light:	Infrared light
Light source:	LED ²⁾
Light spot (distance):	40 mm (800 mm)
Angle of dispersion:	2.8 °

¹⁾ Object with 90 % reflectance (referred to standard white DIN 5033) ²⁾ Average service life of 100,000 h at T_A = +25 °C

Mechanics/electronics

Supply voltage:	10 V DC ... 30 V DC ¹⁾
Residual ripple:	≤ 10 % ²⁾
Power consumption:	≤ 30 mA ³⁾
Output type:	PNP, Light-switching, open collector
Output current I _{max.} :	100 mA
Response time:	≤ 2 ms ⁴⁾
Switching frequency:	250 Hz ⁵⁾
Electrical connection:	Cable, 3-wire, 2 m ⁶⁾
Cable material:	PVC
Conductor cross-section:	0.14 mm ²

Cable diameter: 3.1 mm
 Circuit protection: A, B, C, D ^{7) 8) 9) 10)}
 Protection class: III
 Weight: 100 g
 Housing material: PBT/PC
 Optics material: PMMA
 Enclosure rating: IP 67
 Ambient temperature operation: -25 °C ... 70 °C
 UL File-No.: UL No. NMFT2.E175606

1) Limit values 2) May not exceed or fall short of V_S tolerances 3) Without load 4) Signal transit time with resistive load 5) With light/dark ratio 1:1 6) Do not bend below 0 °C 7) A = V_S connections reverse-polarity protected 8) B = inputs and output reverse-polarity protected 9) C = interference suppression 10) D = outputs overcurrent and short-circuit protected

Dimensional drawing

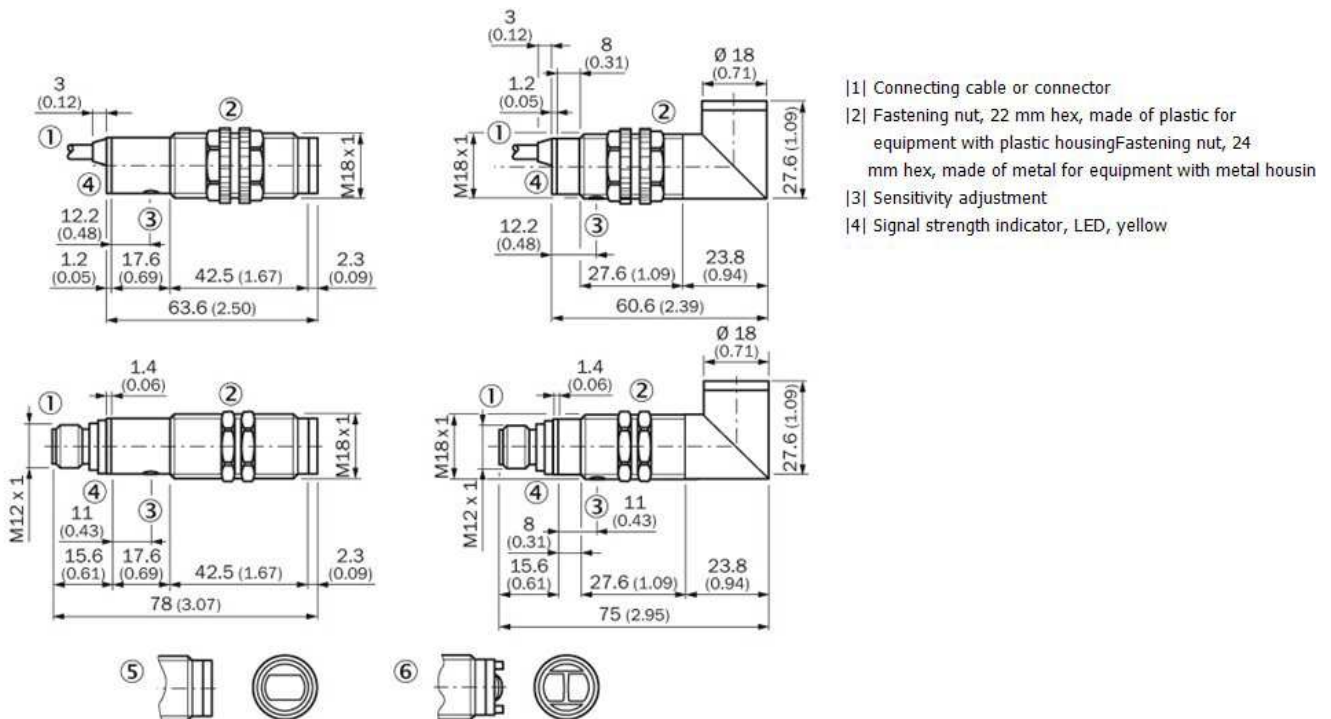

Adjustments possible

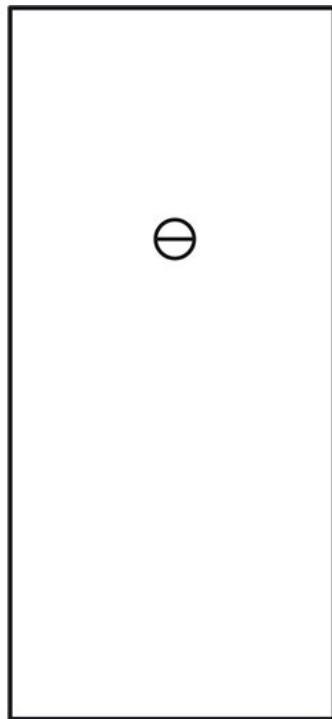

Connection diagram

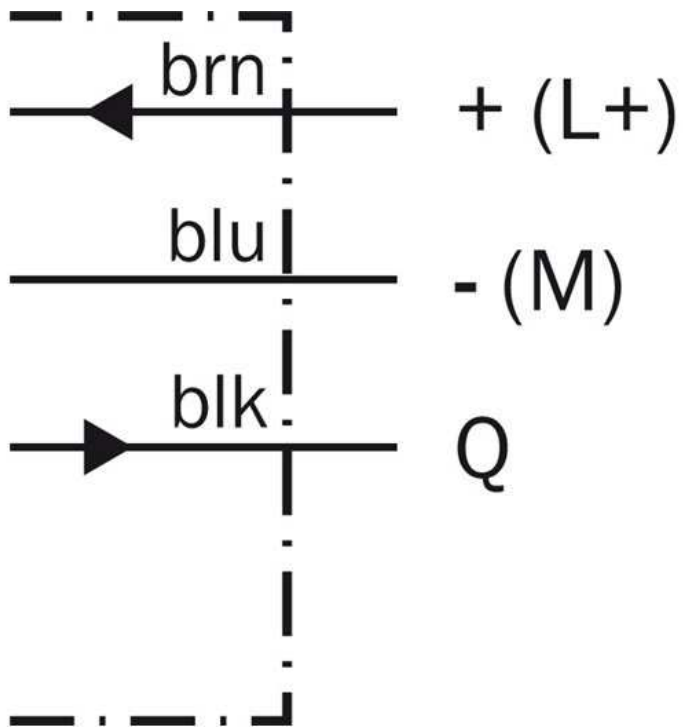

Characteristic curve

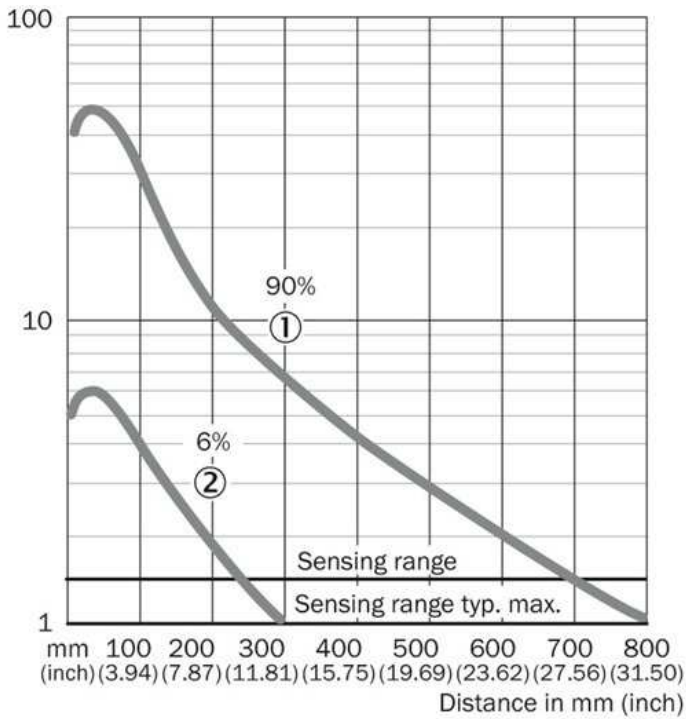

Connection type



Sensing range diagram

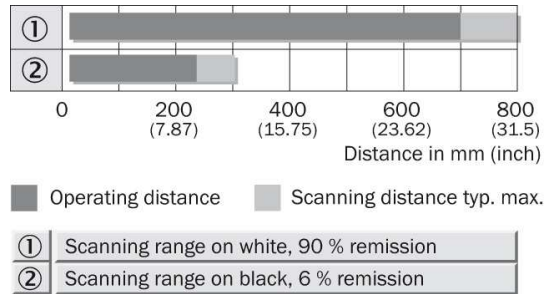

Australia

Phone +61 3 9457 0600
1800 33 48 02 – tollfree
E-Mail sales@sick.com.au

Belgium/Luxembourg

Phone +32 (0)2 466 55 66
E-Mail info@sick.be

Brasil

Phone +55 11 3215-4900
E-Mail marketing@sick.com.br

Canada

Phone +1 905 771 14 44
E-Mail information@sick.com

Česká republika

Phone +420 2 57 91 18 50
E-Mail sick@sick.cz

China

Phone +86 4000 121 000
E-Mail info.china@sick.net.cn
Phone +852-2153 6300
E-Mail ghk@sick.com.hk

Danmark

Phone +45 45 82 64 00
E-Mail sick@sick.dk

Deutschland

Phone +49 211 5301-301
E-Mail info@sick.de

España

Phone +34 93 480 31 00
E-Mail info@sick.es

France

Phone +33 1 64 62 35 00
E-Mail info@sick.fr

Great Britain

Phone +44 (0)1727 831121
E-Mail info@sick.co.uk

India

Phone +91-22-4033 8333
E-Mail info@sick-india.com

Israel

Phone +972-4-6881000
E-Mail info@sick-sensors.com

Italia

Phone +39 02 27 43 41
E-Mail info@sick.it

Japan

Phone +81 (0)3 5309 2112
E-Mail support@sick.jp

Magyarország

Phone +36 1 371 2680
E-Mail office@sick.hu

Nederland

Phone +31 (0)30 229 25 44
E-Mail info@sick.nl

Norge

Phone +47 67 81 50 00
E-Mail sick@sick.no

Österreich

Phone +43 (0)22 36 62 28 8-0
E-Mail office@sick.at

Polska

Phone +48 22 837 40 50
E-Mail info@sick.pl

România

Phone +40 356 171 120
E-Mail office@sick.ro

Russia

Phone +7-495-775-05-30
E-Mail info@sick.ru

Schweiz

Phone +41 41 619 29 39
E-Mail contact@sick.ch

Singapore

Phone +65 6744 3732
E-Mail sales.gsg@sick.com

Slovenija

Phone +386 (0)1-47 69 990
E-Mail office@sick.si

South Africa

Phone +27 11 472 3733
E-Mail info@sickautomation.co.za

South Korea

Phone +82 2 786 6321/4
E-Mail info@sickkorea.net

Suomi

Phone +358-9-25 15 800
E-Mail sick@sick.fi

Sverige

Phone +46 10 110 10 00
E-Mail info@sick.se

Taiwan

Phone +886 2 2375-6288
E-Mail sales@sick.com.tw

Türkiye

Phone +90 (216) 528 50 00
E-Mail info@sick.com.tr

United Arab Emirates

Phone +971 (0) 4 88 65 878
E-Mail info@sick.ae

USA/México

Phone +1(952) 941-6780
1 (800) 325-7425 – tollfree
E-Mail info@sickusa.com

More representatives and agencies
at www.sick.com