



Photoelectric sensors
Energetic, Photoelectric proximity sensor,
Product group W160

WT160-E370



Model Name > [WT160-E370](#)
Part No. > [6022811](#)



- Horizontal models
- Energetic proximity switch for standard applications
- Red light as alignment aid
- Switching point adjustable
- LED indicator: operating reserve



Product features

Sensing range min ... max::	0 mm ... 1,000 mm, 0 mm ... 800 mm
Light source::	LED
Type of light:	Red light
Light spot diameter:	Approx. 90 mm at 500 mm distance
Laser:	Red light
Sensing range max.:	0 mm ... 1,000 mm, 0 mm ... 800 mm
Adjustment::	Potentiometer, 2 rotations
Wave length:	680 nm

Technical data

Design::	Rectangular
Dimensions (W x H x D):	11 mm x 23 mm x 38 mm
Supply voltage min ... max.:	DC 10 ... 30 V ¹⁾
Ripple:	± 10 %
Power consumption:	≤ 25 mA
Output type:	NPN: open collector: Q
Switching mode:	Light/dark switching via rotary switch
Signal voltage NPN HIGH/LOW:	Approx. $V_S / < 1.8 V$
Output current max.:	100 mA
Response time::	≤ 0.5 ms
Switching frequency:	1,000 Hz
Connection type:	Connector, M8, 3-pin
Circuit protection:	V_S connections reverse-polarity protected/In-/outputs short-circuit protected/Interference suppression/Outputs overcurrent and short-circuit protected
Enclosure rating::	IP 67: EN 60529, IP 69K: EN 40050
Ambient operation temperature, min ... max.:	-25 °C ... +55 °C
Ambient storage temperature, min ... max.:	-40 °C ... +70 °C
Weight:	Ca. 20 g
Housing material:	PBT

Angle of dispersion: ca. 10 °
 Series: W160
 Optics material: PMMA
 Housing design: Horizontal

1) Limit values, reverse-polarity protected operation in short-circuit protected network max. 8 A

Dimensional drawing

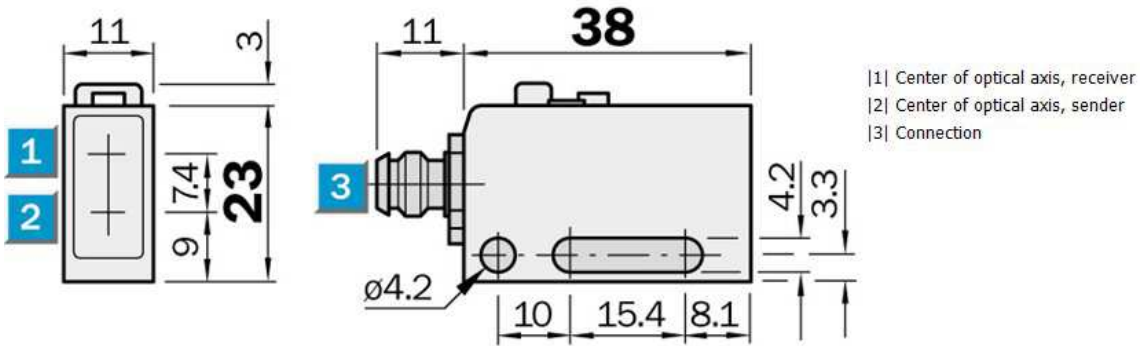

Adjustment possible

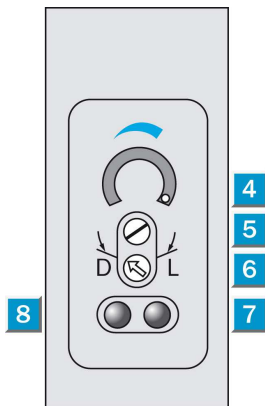

Connection type

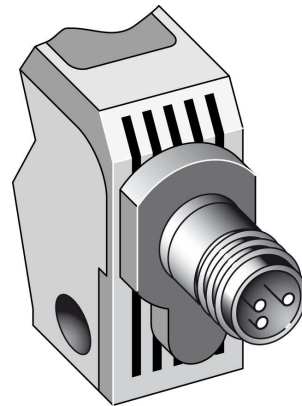

Connection diagram

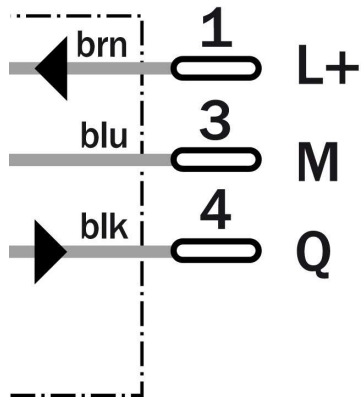

Sensing range diagram

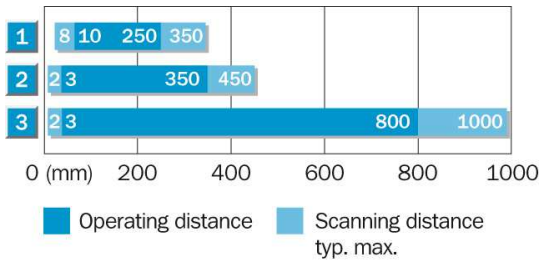

- 1 Scanning range on black, 6 % remission
- 2 Scanning range on grey, 18 % remission
- 3 Scanning range on white, 90 % remission

Characteristic curve

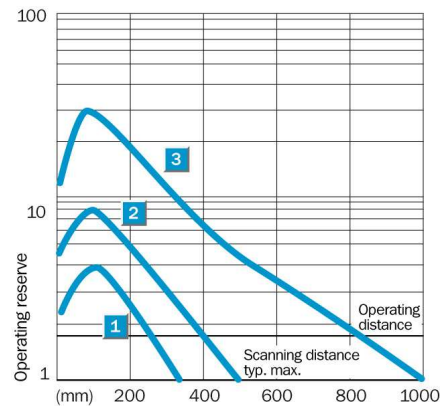

Australia

Phone +61 3 9457 0600
1800 33 48 02 – tollfree
E-Mail sales@sick.com.au

Belgium/Luxembourg

Phone +32 (0)2 466 55 66
E-Mail info@sick.be

Brasil

Phone +55 11 3215-4900
E-Mail marketing@sick.com.br

Canada

Phone +1 905 771 14 44
E-Mail information@sick.com

Česká republika

Phone +420 2 57 91 18 50
E-Mail sick@sick.cz

China

Phone +86 4000 121 000
E-Mail info.china@sick.net.cn
Phone +852-2153 6300
E-Mail ghk@sick.com.hk

Danmark

Phone +45 45 82 64 00
E-Mail sick@sick.dk

Deutschland

Phone +49 211 5301-301
E-Mail info@sick.de

España

Phone +34 93 480 31 00
E-Mail info@sick.es

France

Phone +33 1 64 62 35 00
E-Mail info@sick.fr

Great Britain

Phone +44 (0)1727 831121
E-Mail info@sick.co.uk

India

Phone +91-22-4033 8333
E-Mail info@sick-india.com

Israel

Phone +972-4-6881000
E-Mail info@sick-sensors.com

Italia

Phone +39 02 27 43 41
E-Mail info@sick.it

Japan

Phone +81 (0)3 5309 2112
E-Mail support@sick.jp

Magyarország

Phone +36 1 371 2680
E-Mail office@sick.hu

Nederland

Phone +31 (0)30 229 25 44
E-Mail info@sick.nl

Norge

Phone +47 67 81 50 00
E-Mail sick@sick.no

Österreich

Phone +43 (0)22 36 62 28 8-0
E-Mail office@sick.at

Polska

Phone +48 22 837 40 50
E-Mail info@sick.pl

România

Phone +40 356 171 120
E-Mail office@sick.ro

Russia

Phone +7-495-775-05-30
E-Mail info@sick.ru

Schweiz

Phone +41 41 619 29 39
E-Mail contact@sick.ch

Singapore

Phone +65 6744 3732
E-Mail sales.gsg@sick.com

Slovenija

Phone +386 (0)1-47 69 990
E-Mail office@sick.si

South Africa

Phone +27 11 472 3733
E-Mail info@sickautomation.co.za

South Korea

Phone +82 2 786 6321/4
E-Mail info@sickkorea.net

Suomi

Phone +358-9-25 15 800
E-Mail sick@sick.fi

Sverige

Phone +46 10 110 10 00
E-Mail info@sick.se

Taiwan

Phone +886 2 2375-6288
E-Mail sales@sick.com.tw

Türkiye

Phone +90 (216) 528 50 00
E-Mail info@sick.com.tr

United Arab Emirates

Phone +971 (0) 4 88 65 878
E-Mail info@sick.ae

USA/México

Phone +1(952) 941-6780
1 (800) 325-7425 – tollfree
E-Mail info@sickusa.com

More representatives and agencies
at www.sick.com