

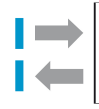

Photoelectric sensors  
Energetic, Photoelectric proximity sensor,  
Product group W140-2

WTE140-2N330

**Model Name** > [WTE140-2N330](#)  
**Part No.** > [6024802](#)



- Energetic photoelectric switch for standard applications
- Adjustable switching point
- Red light as alignment aid
- LED indicator: operating reserve



### Product features

Sensing range min ... max::	0 mm ... 1,000 mm, 0 mm ... 800 mm
Light source::	LED
Type of light:	Red light
Light spot diameter:	Approx. 50 mm at 300 mm distance
Laser:	Red light
Sensing range max.:	0 mm ... 1,000 mm, 0 mm ... 800 mm
Adjustment::	Potentiometer
Wave length:	680 nm

### Technical data

Design::	Rectangular
Dimensions (W x H x D):	11 mm x 31 mm x 20 mm
Supply voltage min ... max.:	DC 10 ... 30 V <sup>1)</sup>
Ripple:	± 10 %
Power consumption:	≤ 30 mA
Output type:	NPN: open collector: Q
Switching mode:	Light/dark switching via rotary switch
Signal voltage NPN HIGH/LOW:	Approx. $V_S / < 1.8 V$
Output current max.:	100 mA
Response time::	≤ 0.5 ms
Switching frequency:	1,000 Hz
Connection type:	Connector, M8, 3-pin
Circuit protection:	$V_S$ connections reverse-polarity protected/In-/outputs short-circuit protected/Interference suppression/Outputs overcurrent and short-circuit protected
Enclosure rating::	IP 67
Ambient operation temperature, min ... max.:	-25 °C ... +55 °C
Ambient storage temperature, min ... max:	-40 °C ... +70 °C
Weight:	Ca. 9 g
Housing material:	PBT
Angle of dispersion:	ca. 9.6 °

Series: W140-2

Optics material: PC

1) Limit values, reverse-polarity protected operation in short-circuit protected network max. 8 A

### Dimensional drawing

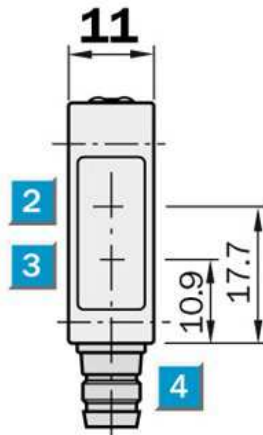
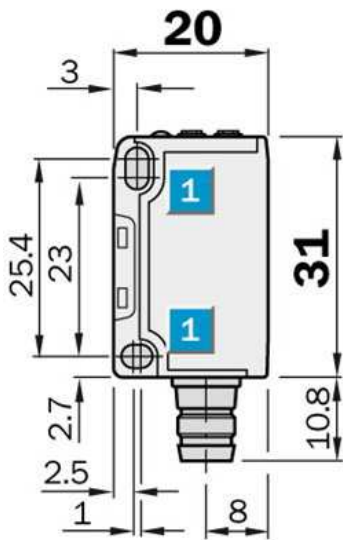

- |1| Mounting hole,  $\phi$  3.2 mm for M3
- |2| Center of optical axis, receiver
- |3| Center of optical axis, sender
- |4| Connection

### Adjustment possible

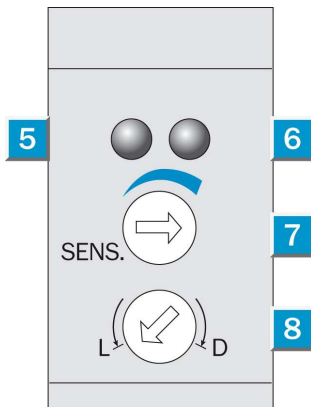

### Connection type

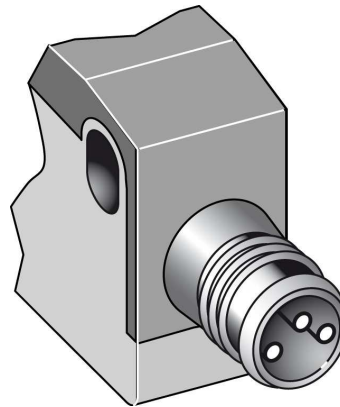

**Connection diagram**

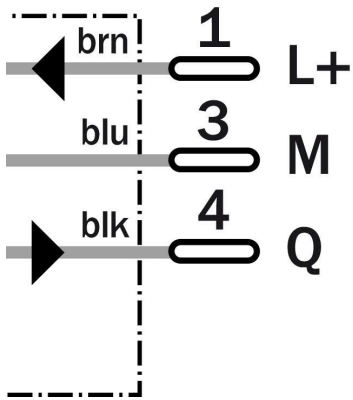

**Sensing range diagram**

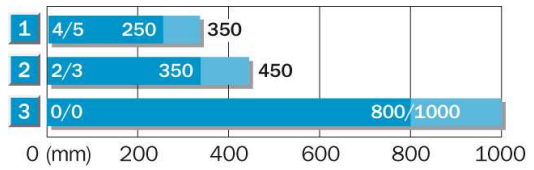

1	Scanning range on black, 6 % reflectance
2	Scanning range on gray, 18 % reflectance
3	Scanning range on white, 90 % reflectance

**Australia**

Phone +61 3 9457 0600  
1800 33 48 02 – tollfree  
E-Mail sales@sick.com.au

**Belgium/Luxembourg**

Phone +32 (0)2 466 55 66  
E-Mail info@sick.be

**Brasil**

Phone +55 11 3215-4900  
E-Mail marketing@sick.com.br

**Canada**

Phone +1 905 771 14 44  
E-Mail information@sick.com

**Česká republika**

Phone +420 2 57 91 18 50  
E-Mail sick@sick.cz

**China**

Phone +86 4000 121 000  
E-Mail info.china@sick.net.cn  
Phone +852-2153 6300  
E-Mail ghk@sick.com.hk

**Danmark**

Phone +45 45 82 64 00  
E-Mail sick@sick.dk

**Deutschland**

Phone +49 211 5301-301  
E-Mail info@sick.de

**España**

Phone +34 93 480 31 00  
E-Mail info@sick.es

**France**

Phone +33 1 64 62 35 00  
E-Mail info@sick.fr

**Great Britain**

Phone +44 (0)1727 831121  
E-Mail info@sick.co.uk

**India**

Phone +91-22-4033 8333  
E-Mail info@sick-india.com

**Israel**

Phone +972-4-6881000  
E-Mail info@sick-sensors.com

**Italia**

Phone +39 02 27 43 41  
E-Mail info@sick.it

**Japan**

Phone +81 (0)3 5309 2112  
E-Mail support@sick.jp

**Magyarország**

Phone +36 1 371 2680  
E-Mail office@sick.hu

**Nederland**

Phone +31 (0)30 229 25 44  
E-Mail info@sick.nl

**Norge**

Phone +47 67 81 50 00  
E-Mail sick@sick.no

**Österreich**

Phone +43 (0)22 36 62 28 8-0  
E-Mail office@sick.at

**Polska**

Phone +48 22 837 40 50  
E-Mail info@sick.pl

**România**

Phone +40 356 171 120  
E-Mail office@sick.ro

**Russia**

Phone +7-495-775-05-30  
E-Mail info@sick.ru

**Schweiz**

Phone +41 41 619 29 39  
E-Mail contact@sick.ch

**Singapore**

Phone +65 6744 3732  
E-Mail sales.gsg@sick.com

**Slovenija**

Phone +386 (0)1-47 69 990  
E-Mail office@sick.si

**South Africa**

Phone +27 11 472 3733  
E-Mail info@sickautomation.co.za

**South Korea**

Phone +82 2 786 6321/4  
E-Mail info@sickkorea.net

**Suomi**

Phone +358-9-25 15 800  
E-Mail sick@sick.fi

**Sverige**

Phone +46 10 110 10 00  
E-Mail info@sick.se

**Taiwan**

Phone +886 2 2375-6288  
E-Mail sales@sick.com.tw

**Türkiye**

Phone +90 (216) 528 50 00  
E-Mail info@sick.com.tr

**United Arab Emirates**

Phone +971 (0) 4 88 65 878  
E-Mail info@sick.ae

**USA/México**

Phone +1(952) 941-6780  
1 (800) 325-7425 – tollfree  
E-Mail info@sickusa.com

More representatives and agencies  
at [www.sick.com](http://www.sick.com)