



Optical data transmission ISD300

ISD300-1112



Model Name > [ISD300-1112](#)
Part No. > [6024837](#)



At a glance

- PROFIBUS interface
- Push button displays opposing device's reception level for simple one man alignment
- Up to 1.5 Mbit/s transfer rate
- Integrated 3-point mounting bracket

Your benefits

- Non-contact system eliminates wear and tear thus guaranteeing high machine uptime and significantly reduced maintenance costs
- Electronic alignment methods significantly reduce installation times thus saving costs
- Very long scanning range ensures high gain reserve even in challenging environmental conditions
- Reduced installation costs by eliminating cables
- Excellent ambient light immunity and EMC compatibility ensure accurate and reliable data transmission
- Increased system speed with fast data transmission
- Fast and easy integration into PROFIBUS network without additional converter cards
- Fast and easy assembly with integrated 3-point mounting bracket reduces installation time and costs



CE RS-485

Performance

Light source:	LED, infrared (880 nm)
Heating:	-
Typ. light spot size (distance):	1.75 m (at 100 m)
Transmission range:	0.2 m ... 120 m
Field of view:	Ca. ± 0.5 °

Interfaces

Data transmission rate:	1.5 Mbit/s
Output type:	0 V ... 2 V: interference-free operation VS -2 V: reduced system reserve
Switching input:	0 V ... 2 V: sender deactivated
Signal delay:	≤ 1.5 µs + 1 Tbit
Data interface ¹⁾ :	RS-485/PROFIBUS DP

1) RS-485 on request

Mechanics/electronics

Supply voltage Vs:	DC 18 V ... 30 V
Power consumption:	≤ 0.2 A
Weight:	Ca. 1.2 kg
Housing material:	Metal
Electrical connection:	Terminals
Frequency:	F2 ¹⁾

1) A pair of devices with numbers ending in 1 and 2 are required to create a data transfer section.

Ambient data

Enclosure rating:	IP 65
Protection class:	I
Electromagnetic compatibility (EMC):	EN 61000-6-2/EN 61000-6-4 ¹⁾
Ambient temperature:	Storage: -30 ... +70 °C
Ambient temperature operation:	-5 °C ... +50 °C
Max. rel. humidity (not condensing):	90 %, non-condensing

1) This is a Class A device. This device can cause radio interference in living quarters.

Dimensional drawing

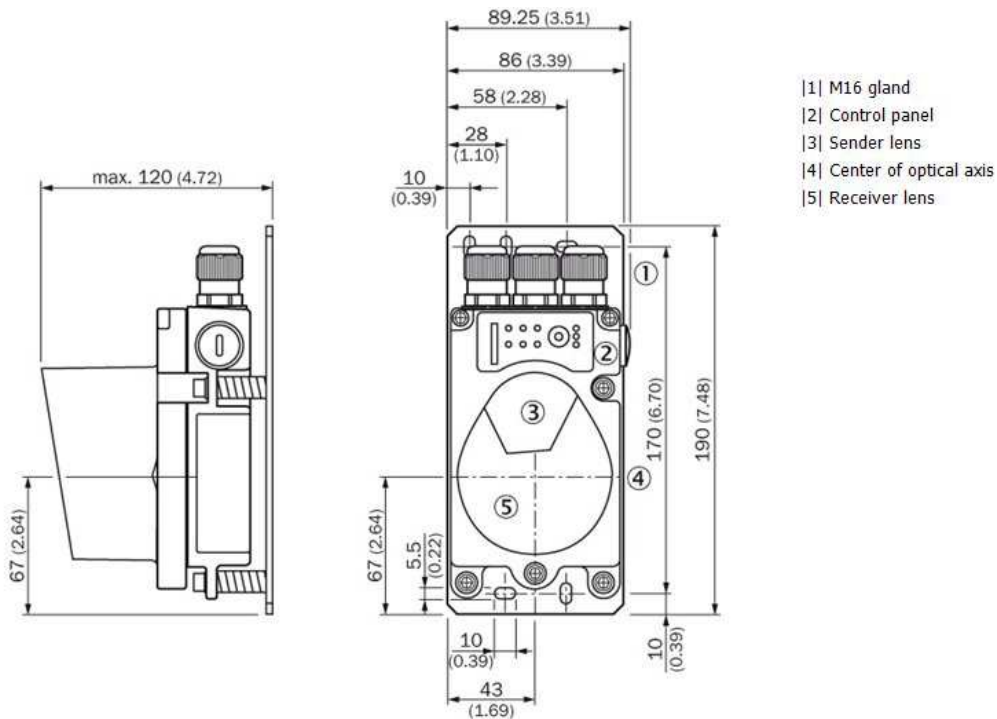

Adjustments

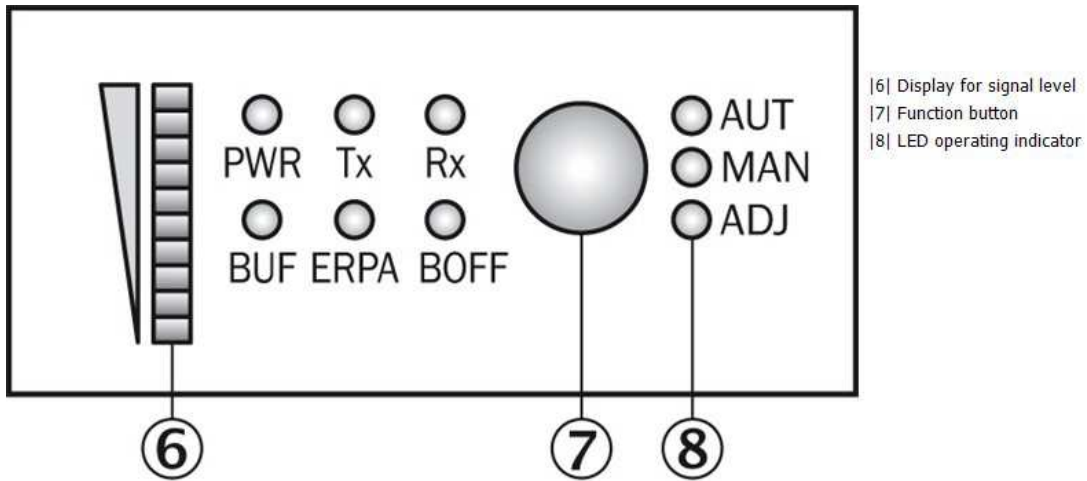

Connection type

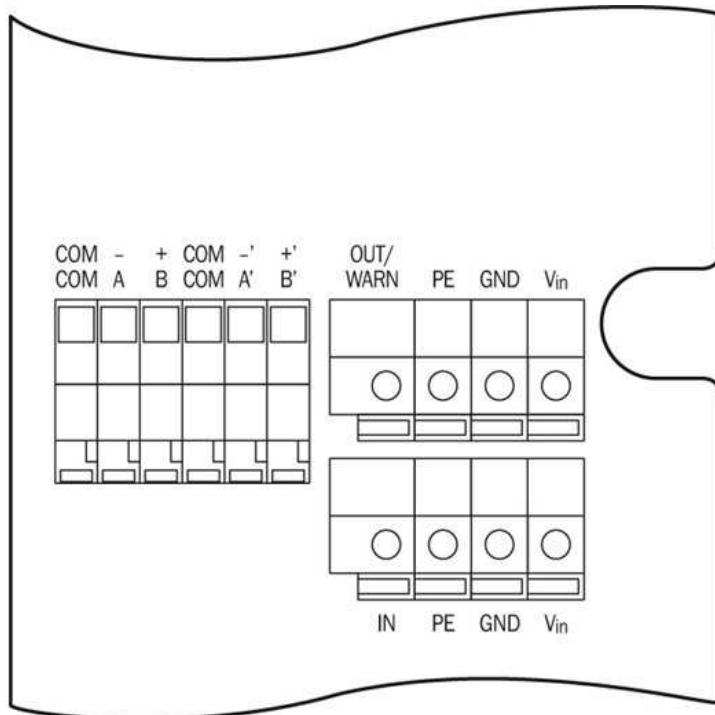

Connection diagram

Terminals, general

V_{in}	L+
GND	M
PE	Shield
OUT/WARN	Q
IN	Switch. input

Terminals, PROFIBUS

A, -	A wire
B, +	B wire
COM	Pot. balance
A', -'	A wire
B', +'	B wire

Australia

Phone +61 3 9457 0600
1800 33 48 02 – tollfree
E-Mail sales@sick.com.au

Belgium/Luxembourg

Phone +32 (0)2 466 55 66
E-Mail info@sick.be

Brasil

Phone +55 11 3215-4900
E-Mail marketing@sick.com.br

Canada

Phone +1 905 771 14 44
E-Mail information@sick.com

Česká republika

Phone +420 2 57 91 18 50
E-Mail sick@sick.cz

China

Phone +86 4000 121 000
E-Mail info.china@sick.net.cn
Phone +852-2153 6300
E-Mail ghk@sick.com.hk

Danmark

Phone +45 45 82 64 00
E-Mail sick@sick.dk

Deutschland

Phone +49 211 5301-301
E-Mail info@sick.de

España

Phone +34 93 480 31 00
E-Mail info@sick.es

France

Phone +33 1 64 62 35 00
E-Mail info@sick.fr

Great Britain

Phone +44 (0)1727 831121
E-Mail info@sick.co.uk

India

Phone +91-22-4033 8333
E-Mail info@sick-india.com

Israel

Phone +972-4-6881000
E-Mail info@sick-sensors.com

Italia

Phone +39 02 27 43 41
E-Mail info@sick.it

Japan

Phone +81 (0)3 5309 2112
E-Mail support@sick.jp

Magyarország

Phone +36 1 371 2680
E-Mail office@sick.hu

Nederland

Phone +31 (0)30 229 25 44
E-Mail info@sick.nl

Norge

Phone +47 67 81 50 00
E-Mail sick@sick.no

Österreich

Phone +43 (0)22 36 62 28 8-0
E-Mail office@sick.at

Polska

Phone +48 22 837 40 50
E-Mail info@sick.pl

România

Phone +40 356 171 120
E-Mail office@sick.ro

Russia

Phone +7-495-775-05-30
E-Mail info@sick.ru

Schweiz

Phone +41 41 619 29 39
E-Mail contact@sick.ch

Singapore

Phone +65 6744 3732
E-Mail sales.gsg@sick.com

Slovenija

Phone +386 (0)1-47 69 990
E-Mail office@sick.si

South Africa

Phone +27 11 472 3733
E-Mail info@sickautomation.co.za

South Korea

Phone +82 2 786 6321/4
E-Mail info@sickkorea.net

Suomi

Phone +358-9-25 15 800
E-Mail sick@sick.fi

Sverige

Phone +46 10 110 10 00
E-Mail info@sick.se

Taiwan

Phone +886 2 2375-6288
E-Mail sales@sick.com.tw

Türkiye

Phone +90 (216) 528 50 00
E-Mail info@sick.com.tr

United Arab Emirates

Phone +971 (0) 4 88 65 878
E-Mail info@sick.ae

USA/México

Phone +1(952) 941-6780
1 (800) 325-7425 – tollfree
E-Mail info@sickusa.com

More representatives and agencies
at www.sick.com