



Safety relays
Main unit UE43-3MF

UE43-3MF2A3



Model Name > [UE43-3MF2A3](#)
Part No. > [6024901](#)



At a glance

- Evaluation unit for emergency stop pushbuttons and safety switches
- Cross circuit detection and sequence monitoring for the dual-channel input signal
- Monitoring the discrepancy time is possible
- 3 safety outputs, 1 application diagnostic output
- Combines the advantages of classic relays and easy circuitry
- Manual or automatic reset

Your benefits

- Complete monitoring and analysis of sensors
- Fast diagnostics via the status information reduces downtime
- Offers all contact paths needed

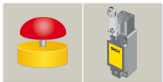

Applications

| | |
|---|---------------|
| Type of switching amplifier: | Main unit |
| Emergency stop pushbuttons: | ✓ |
| Safety switches: | ✓ |
| Safety Switch with mechanical lock: | - |
| Two-hand control systems: | - |
| Pressure sensitive mats: | - |
| Opto-electronic protective devices: | - |
| Opto-electronic protective devices without RES/EDM: | - |
| Opto-electronic protective devices with RES/EDM: | - |
| System part: | Safety relays |

Functions

| | |
|------------------------------|-------------------------------|
| Input circuit:: | Single- or dual-channel |
| Cross-circuit detection: | ✓ |
| Reset/restart: | Manual/automatic/configurable |
| External device monitoring: | ✓ |
| Synchronous time monitoring: | ✓ |

Technical data

| | |
|-------------------------|--------------------------------------|
| Safety integrity level: | SIL3 (IEC 61508), SILCL3 (IEC 62061) |
| Category: | category 4 (EN ISO 13849) |
| Performance level: | PL e (EN ISO 13849) |

| | |
|--|---|
| B10d parameter: | 1* 1E 06 switching cycles (AC-15, 230 V, I = 0.5 A) 3.5*1E 05 switching cycles (DC-13, 24 V, I = 2 A) 1.2 * 1E 06 switching cycles (DC-13, 24 V, I = 0.5 A) |
| PFHd: | 3.0 * 1E-08 |
| TM (mission time): | 20 a |
| Stop category: | 0, EN 60204 |
| Width: | 45 mm |
| Contact type: | Positively driven |
| Number of enable current contacts: | 3 |
| Number of signalling current contacts: | 1 |
| Operating voltage AC: | 230 V AC |
| Maximum power consumption AC: | 3.2 VA |
| Maximum power consumption DC: | 2.5 W |
| Type of output: | Relay contacts |
| Rated operating current (voltage): | 6 A (230 V AC) 3600 switching cycles/h 6 A (24 V DC) 360 switching cycles/h 3 A (24 V DC) 3600 switching cycles/h |
| Maximum switching current: | 6 A |
| Maximum total current: | 18 A |
| Mechanical life (relay contacts): | 1*1E 07 switching cycles |
| Electrical life (relay contacts): | 2* 1E 06 switching cycles, dependent upon loading, details see operating instructions |
| Enclosure rating: | IP 20 |
| Ambient operating temperature from ... to: | -25 °C ... 55 °C |
| Connection type: | Screw-type terminals |

Connection diagram

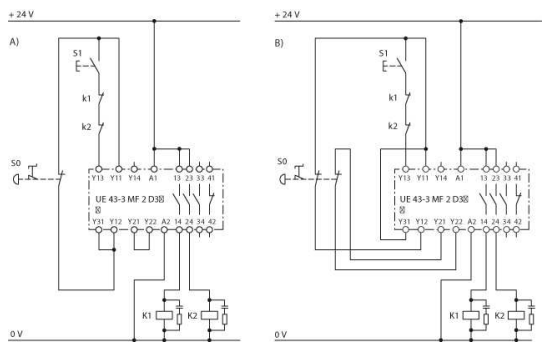

Dimensional drawing

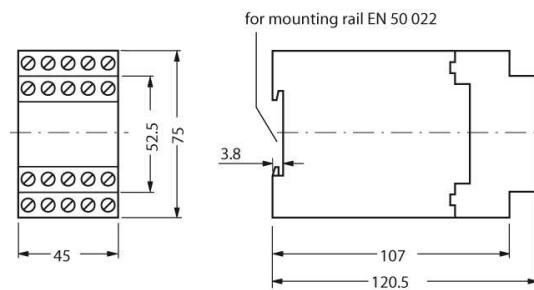

Australia

Phone +61 3 9457 0600
1800 33 48 02 – tollfree
E-Mail sales@sick.com.au

Belgium/Luxembourg

Phone +32 (0)2 466 55 66
E-Mail info@sick.be

Brasil

Phone +55 11 3215-4900
E-Mail marketing@sick.com.br

Canada

Phone +1 905 771 14 44
E-Mail information@sick.com

Česká republika

Phone +420 2 57 91 18 50
E-Mail sick@sick.cz

China

Phone +86 4000 121 000
E-Mail info.china@sick.net.cn
Phone +852-2153 6300
E-Mail ghk@sick.com.hk

Danmark

Phone +45 45 82 64 00
E-Mail sick@sick.dk

Deutschland

Phone +49 211 5301-301
E-Mail info@sick.de

España

Phone +34 93 480 31 00
E-Mail info@sick.es

France

Phone +33 1 64 62 35 00
E-Mail info@sick.fr

Great Britain

Phone +44 (0)1727 831121
E-Mail info@sick.co.uk

India

Phone +91-22-4033 8333
E-Mail info@sick-india.com

Israel

Phone +972-4-6881000
E-Mail info@sick-sensors.com

Italia

Phone +39 02 27 43 41
E-Mail info@sick.it

Japan

Phone +81 (0)3 5309 2112
E-Mail support@sick.jp

Magyarország

Phone +36 1 371 2680
E-Mail office@sick.hu

Nederland

Phone +31 (0)30 229 25 44
E-Mail info@sick.nl

Norge

Phone +47 67 81 50 00
E-Mail sick@sick.no

Österreich

Phone +43 (0)22 36 62 28 8-0
E-Mail office@sick.at

Polska

Phone +48 22 837 40 50
E-Mail info@sick.pl

România

Phone +40 356 171 120
E-Mail office@sick.ro

Russia

Phone +7-495-775-05-30
E-Mail info@sick.ru

Schweiz

Phone +41 41 619 29 39
E-Mail contact@sick.ch

Singapore

Phone +65 6744 3732
E-Mail sales.gsg@sick.com

Slovenija

Phone +386 (0)1-47 69 990
E-Mail office@sick.si

South Africa

Phone +27 11 472 3733
E-Mail info@sickautomation.co.za

South Korea

Phone +82 2 786 6321/4
E-Mail info@sickkorea.net

Suomi

Phone +358-9-25 15 800
E-Mail sick@sick.fi

Sverige

Phone +46 10 110 10 00
E-Mail info@sick.se

Taiwan

Phone +886 2 2375-6288
E-Mail sales@sick.com.tw

Türkiye

Phone +90 (216) 528 50 00
E-Mail info@sick.com.tr

United Arab Emirates

Phone +971 (0) 4 88 65 878
E-Mail info@sick.ae

USA/México

Phone +1(952) 941-6780
1 (800) 325-7425 – tollfree
E-Mail info@sickusa.com

More representatives and agencies
at www.sick.com