



Safety relays
Main unit UE45-3S1

UE45-3S13D33



Model Name > [UE45-3S13D33](#)
Part No. > [6024912](#)



At a glance

- Ideal for evaluating emergency stop pushbuttons and safety switches
- Cross circuit detection and sequence monitoring at the dual-channel input signal
- 2 N/O contacts for a direct integration into the machine
- 1 N/O time delayed up to 30 s for stop category 1 applications
- Manual or automatic reset
- Coded version for all plug-in positions

Your benefits

- Complete monitoring and analysis of sensors
- Time delay provides optimal protection of brake applications
- Adjustable time delay at the front of the device (up to 30 s) makes it easy for the user to change settings
- Tool-free exchange via coded pluggable terminals
- Combines the advantages of classic relays and easy circuitry



Applications

Type of switching amplifier:	Main unit
Emergency stop pushbuttons:	✓
Safety switches:	✓
Safety Switch with mechanical lock:	-
Two-hand control systems:	-
Pressure sensitive mats:	-
Opto-electronic protective devices:	-
Opto-electronic protective devices without RES/EDM:	-
Opto-electronic protective devices with RES/EDM:	-
System part:	Safety relays

Functions

Input circuit::	Single- or dual-channel
Cross-circuit detection:	✓
Reset/restart:	Manual/automatic/configurable
External device monitoring:	✓
Synchronous time monitoring:	✓

Technical data

Safety integrity level::	SILCL3 (IEC 62061) ^{1) 2)} SILCL2 (IEC 62061)
Category::	Category 4 (EN ISO 13849) ^{3) 4)} category 3 (EN ISO 13849)
Performance level::	PL e (EN ISO 13849) ^{5) 6)} PL d (EN ISO 13849)
B10d parameter:	4*1E 05 switching cycles (with maximum load)
PFHd:	3.0 * 1E-08 2.0 * 1E-08
TM (mission time):	20 a
Stop category:	1, 0, EN 60204
Width:	22.5 mm
Contact type:	Positively driven
Number of enable current contacts:	2
Number of off-delayed N/O contacts:	1
Number of signalling current contacts:	0
Delay time:	0.15 s ... 3 s
Operating voltage DC:	24 V DC
Maximum power consumption DC:	2.6 W
Type of output:	Relay contacts
Rated operating current (voltage):	4 A (230 V AC) 3600 switching cycles/h 5 A (24 V DC) 360 switching cycles/h 3 A (24 V DC) 3600 switching cycles/h
Maximum switching current:	6 A
Maximum total current:	12 A
Mechanical life (relay contacts):	5*1E 06 switching cycles
Electrical life (relay contacts):	2* 1E 06 switching cycles, dependent upon loading, details see operating instructions
Enclosure rating:	IP 20
Ambient operating temperature from ... to:	-25 °C ... 55 °C
Connection type:	Plug-in terminals

1) 3) 5) For contacts 13/14, 23/24 2) 4) 6) For time contacts 37/38

Connection diagram

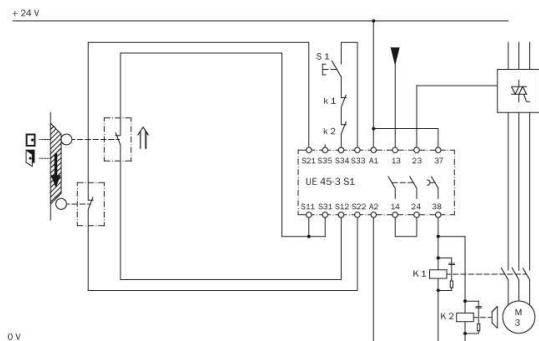

Dimensional drawing

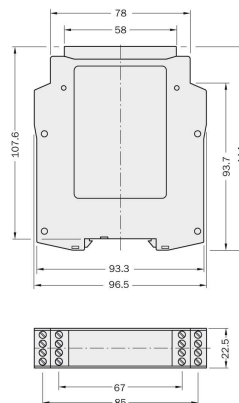

Australia

Phone +61 3 9457 0600
1800 33 48 02 – tollfree
E-Mail sales@sick.com.au

Belgium/Luxembourg

Phone +32 (0)2 466 55 66
E-Mail info@sick.be

Brasil

Phone +55 11 3215-4900
E-Mail marketing@sick.com.br

Canada

Phone +1 905 771 14 44
E-Mail information@sick.com

Česká republika

Phone +420 2 57 91 18 50
E-Mail sick@sick.cz

China

Phone +86 4000 121 000
E-Mail info.china@sick.net.cn
Phone +852-2153 6300
E-Mail ghk@sick.com.hk

Danmark

Phone +45 45 82 64 00
E-Mail sick@sick.dk

Deutschland

Phone +49 211 5301-301
E-Mail info@sick.de

España

Phone +34 93 480 31 00
E-Mail info@sick.es

France

Phone +33 1 64 62 35 00
E-Mail info@sick.fr

Great Britain

Phone +44 (0)1727 831121
E-Mail info@sick.co.uk

India

Phone +91-22-4033 8333
E-Mail info@sick-india.com

Israel

Phone +972-4-6881000
E-Mail info@sick-sensors.com

Italia

Phone +39 02 27 43 41
E-Mail info@sick.it

Japan

Phone +81 (0)3 5309 2112
E-Mail support@sick.jp

Magyarország

Phone +36 1 371 2680
E-Mail office@sick.hu

Nederland

Phone +31 (0)30 229 25 44
E-Mail info@sick.nl

Norge

Phone +47 67 81 50 00
E-Mail sick@sick.no

Österreich

Phone +43 (0)22 36 62 28 8-0
E-Mail office@sick.at

Polska

Phone +48 22 837 40 50
E-Mail info@sick.pl

România

Phone +40 356 171 120
E-Mail office@sick.ro

Russia

Phone +7-495-775-05-30
E-Mail info@sick.ru

Schweiz

Phone +41 41 619 29 39
E-Mail contact@sick.ch

Singapore

Phone +65 6744 3732
E-Mail sales.gsg@sick.com

Slovenija

Phone +386 (0)1-47 69 990
E-Mail office@sick.si

South Africa

Phone +27 11 472 3733
E-Mail info@sickautomation.co.za

South Korea

Phone +82 2 786 6321/4
E-Mail info@sickkorea.net

Suomi

Phone +358-9-25 15 800
E-Mail sick@sick.fi

Sverige

Phone +46 10 110 10 00
E-Mail info@sick.se

Taiwan

Phone +886 2 2375-6288
E-Mail sales@sick.com.tw

Türkiye

Phone +90 (216) 528 50 00
E-Mail info@sick.com.tr

United Arab Emirates

Phone +971 (0) 4 88 65 878
E-Mail info@sick.ae

USA/México

Phone +1(952) 941-6780
1 (800) 325-7425 – tollfree
E-Mail info@sickusa.com

More representatives and agencies
at www.sick.com