



Photoelectric sensors  
V18 Laser, Photoelectric retro-reflective sensor,  
Standard optics

VL18L-4P344



**Model Name** > VL18L-4P344  
**Part No.** > 6027434



*Illustration may differ*

**At a glance**

- Laser emitter LED enclosed in a cylindrical M18 housing
- Sensing distance up to 35 m
- Fast response time
- Straight or right-angle housing
- Durable metal housing
- IP 67
- Small visible light spot to detect small objects
- Laser class 1

**Your benefits**

- Lowest-cost laser sensor in M18 cylindrical housing saves installation costs
- Time saving installation and alignment with highly visible light spot
- Laser class 1 does not require increased safety measures or markings, reducing installation costs
- Fast response time ensures reliable object detection at high speeds and increases machine throughput
- Polarizing filter prevents false readings on reflective surfaces, reducing downtime



**Features**

Sensor/detection principle:	Photoelectric retro-reflective sensor, Standard optics
Housing design (light emission):	Cylindrical, angled, straight
Housing length:	107.7 mm
Thread diameter (housing):	M18 x 1
Optical axis:	radial
Sensing range max.:	0.1 m ... 35 m <sup>1)</sup>
Sensing range:	0.1 m ... 30 m <sup>2)</sup>
Type of light:	Visible red light
Light source:	Laser <sup>3)</sup>
Light spot (distance):	9 mm (35 m)
Laser class:	1 (IEC 60825-1)
Wave length:	650 nm
Sensitivity adjustment:	Electronic, via control input C (0 V) manual, via teach-in button
Angle of dispersion:	0.04 °

1) 2) P250F <sup>3)</sup> Average service life of 100,000 h at T<sub>A</sub> = +25 °C

## Mechanics/electronics

---

Supply voltage:	10 V DC ... 30 V DC <sup>1)</sup>
Residual ripple:	≤ 10 % <sup>2)</sup>
Power consumption:	≤ 20 mA <sup>3)</sup>
Output type:	PNP, Light/dark-switching, Selectable via control input C
Output current I <sub>max.</sub> :	≤ 100 mA
Response time:	≤ 0.625 ms <sup>4)</sup>
Switching frequency:	800 Hz <sup>5)</sup>
Electrical connection:	Connector M12, 4-pin
Circuit protection::::	A, B, C, D <sup>6) 7) 8) 9)</sup>
Protection class:	III
Weight:	60 g
Polarisation filter:	✓
Housing material:	Nickel-plated brass/PC
Optics material:	PC with protective glass pane
Enclosure rating:	IP 67
Ambient temperature operation:	-15 °C ... 55 °C
Ambient storage temperature:	-25 °C ... 70 °C
UL File-No.:	UL No. NRKH.E181493, CDRH-Konform (0312012-00)

<sup>1)</sup> Limit values <sup>2)</sup> May not exceed or fall short of  $V_S$  tolerances <sup>3)</sup> Without load <sup>4)</sup> Signal transit time with resistive load <sup>5)</sup> With light/dark ratio 1:1 <sup>6)</sup> A =  $V_S$  connections reverse-polarity protected <sup>7)</sup> B = interference suppression <sup>8)</sup> D = outputs overcurrent and short-circuit protected <sup>9)</sup> D = inputs and output reverse-polarity protected

## Dimensional drawing

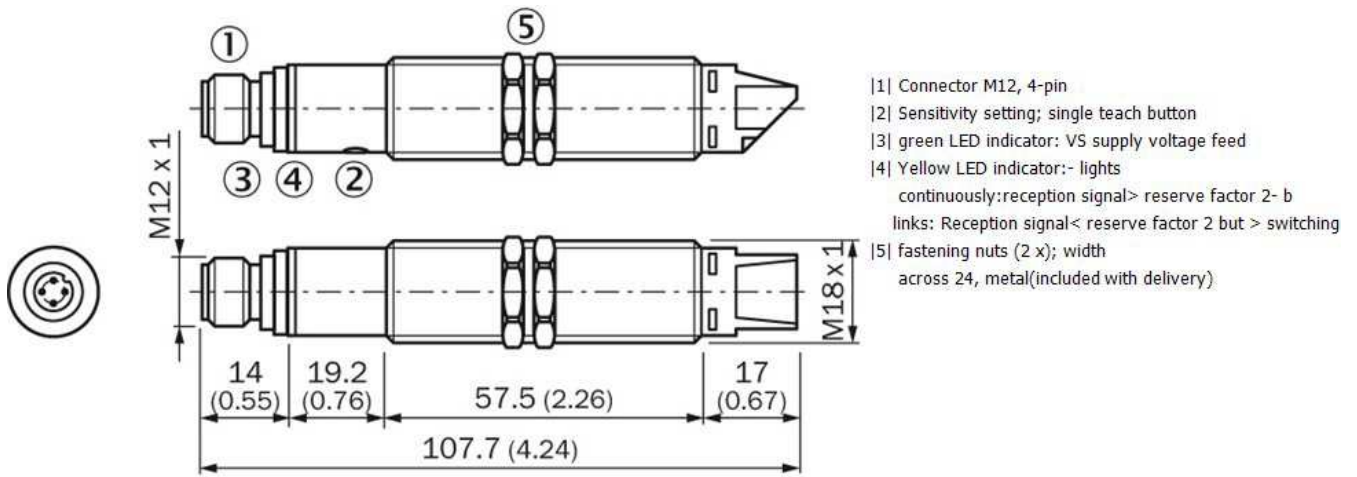

## Adjustments possible

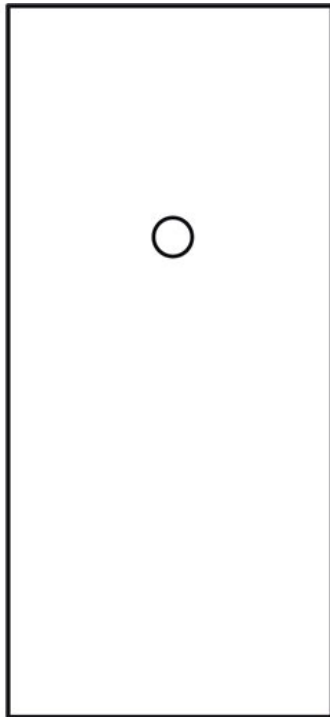

Connection diagram

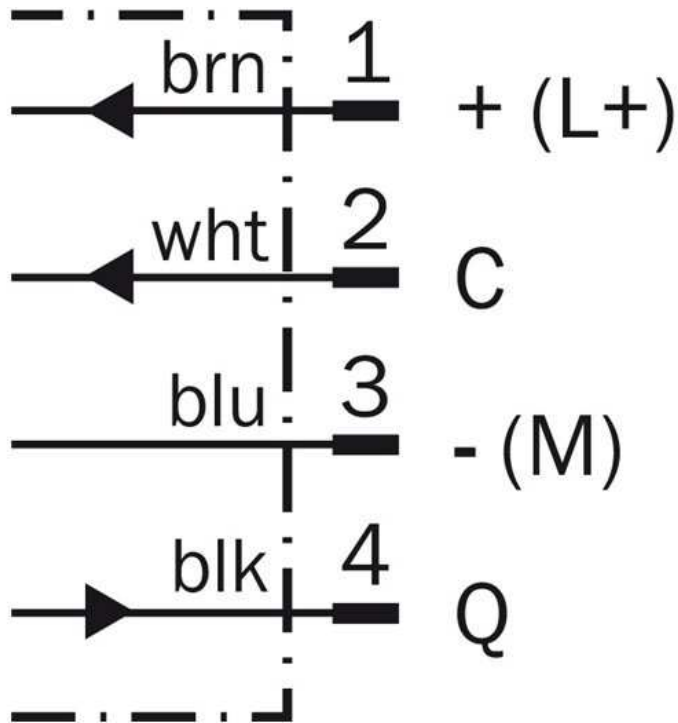

Characteristic curve

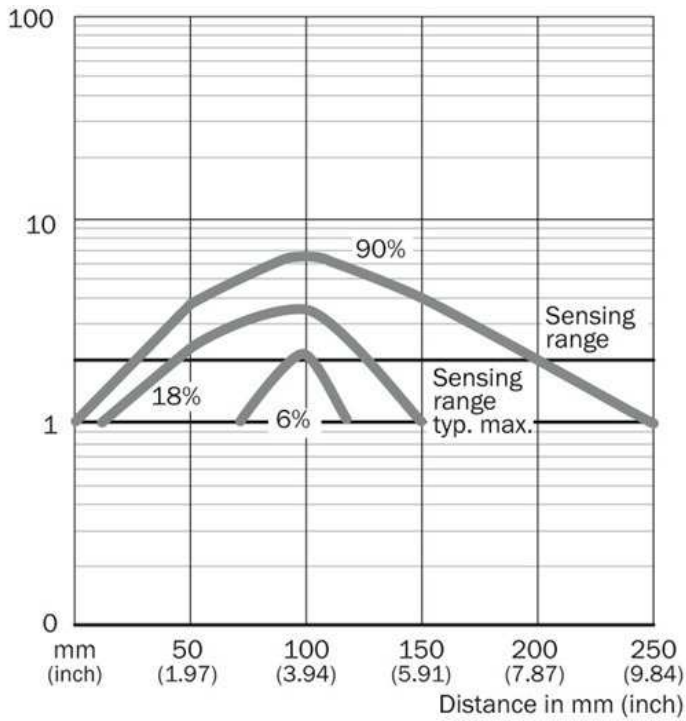

## Characteristic curve

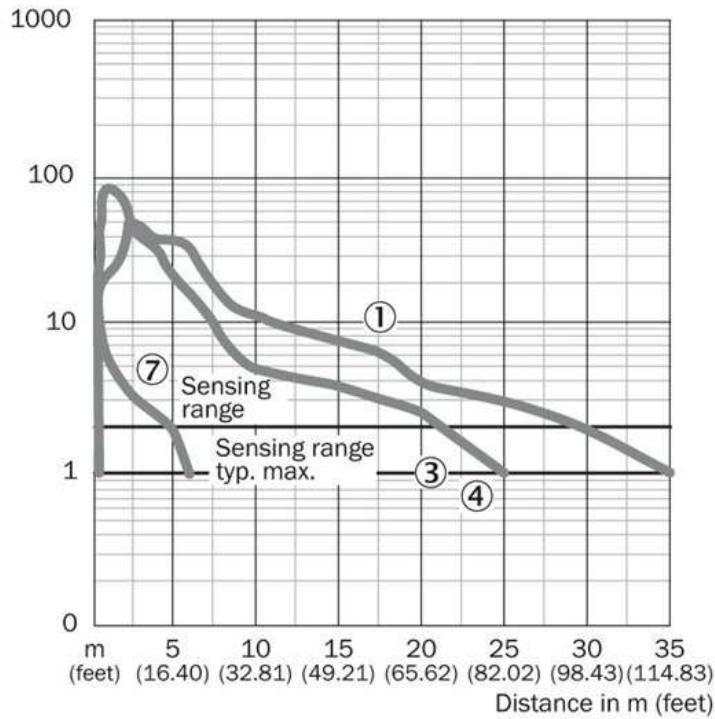

## Sensing range diagram

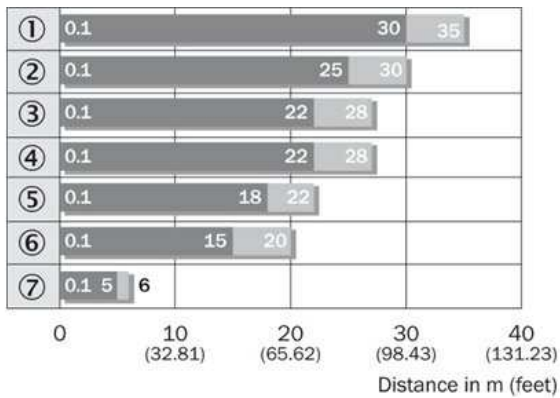

■ Operating range    ■ Scanning range typ. max.

Reflector type	Operating range
① P250F	0.1 (.33) ... 30 (131.23)
② PL10F	0.1 (.33) ... 25 (82.02)
③ PL80A	0.1 (.33) ... 22 (72.18)
④ P 250	0.1 (.33) ... 22 (72.18)
⑤ C110	0.1 (.33) ... 18 (59.06)
⑥ PL10F	0.1 (.33) ... 15 (49.21)
⑦ Reflective tape „Diamond Grade“	0.1 (.33) ... 5 (16.4)

### Connection type



### Light spot size

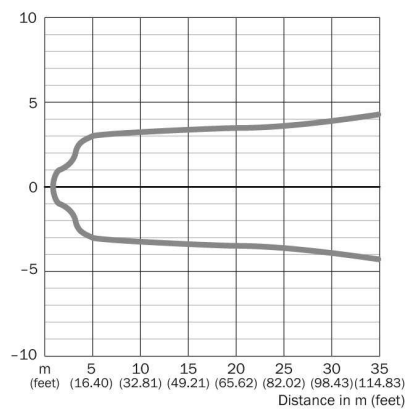

**Australia**

Phone +61 3 9457 0600  
1800 33 48 02 – tollfree  
E-Mail sales@sick.com.au

**Belgium/Luxembourg**

Phone +32 (0)2 466 55 66  
E-Mail info@sick.be

**Brasil**

Phone +55 11 3215-4900  
E-Mail marketing@sick.com.br

**Canada**

Phone +1 905 771 14 44  
E-Mail information@sick.com

**Česká republika**

Phone +420 2 57 91 18 50  
E-Mail sick@sick.cz

**China**

Phone +86 4000 121 000  
E-Mail info.china@sick.net.cn  
Phone +852-2153 6300  
E-Mail ghk@sick.com.hk

**Danmark**

Phone +45 45 82 64 00  
E-Mail sick@sick.dk

**Deutschland**

Phone +49 211 5301-301  
E-Mail info@sick.de

**España**

Phone +34 93 480 31 00  
E-Mail info@sick.es

**France**

Phone +33 1 64 62 35 00  
E-Mail info@sick.fr

**Great Britain**

Phone +44 (0)1727 831121  
E-Mail info@sick.co.uk

**India**

Phone +91-22-4033 8333  
E-Mail info@sick-india.com

**Israel**

Phone +972-4-6881000  
E-Mail info@sick-sensors.com

**Italia**

Phone +39 02 27 43 41  
E-Mail info@sick.it

**Japan**

Phone +81 (0)3 5309 2112  
E-Mail support@sick.jp

**Magyarország**

Phone +36 1 371 2680  
E-Mail office@sick.hu

**Nederland**

Phone +31 (0)30 229 25 44  
E-Mail info@sick.nl

**Norge**

Phone +47 67 81 50 00  
E-Mail sick@sick.no

**Österreich**

Phone +43 (0)22 36 62 28 8-0  
E-Mail office@sick.at

**Polska**

Phone +48 22 837 40 50  
E-Mail info@sick.pl

**România**

Phone +40 356 171 120  
E-Mail office@sick.ro

**Russia**

Phone +7-495-775-05-30  
E-Mail info@sick.ru

**Schweiz**

Phone +41 41 619 29 39  
E-Mail contact@sick.ch

**Singapore**

Phone +65 6744 3732  
E-Mail sales.gsg@sick.com

**Slovenija**

Phone +386 (0)1-47 69 990  
E-Mail office@sick.si

**South Africa**

Phone +27 11 472 3733  
E-Mail info@sickautomation.co.za

**South Korea**

Phone +82 2 786 6321/4  
E-Mail info@sickkorea.net

**Suomi**

Phone +358-9-25 15 800  
E-Mail sick@sick.fi

**Sverige**

Phone +46 10 110 10 00  
E-Mail info@sick.se

**Taiwan**

Phone +886 2 2375-6288  
E-Mail sales@sick.com.tw

**Türkiye**

Phone +90 (216) 528 50 00  
E-Mail info@sick.com.tr

**United Arab Emirates**

Phone +971 (0) 4 88 65 878  
E-Mail info@sick.ae

**USA/México**

Phone +1(952) 941-6780  
1 (800) 325-7425 – tollfree  
E-Mail info@sickusa.com

More representatives and agencies  
at [www.sick.com](http://www.sick.com)