



Photoelectric sensors
V18 Laser, Photoelectric retro-reflective sensor,
Standard optics

VL18L-4N344



Model Name > VL18L-4N344
Part No. > 6027436



Illustration may differ

At a glance

- Laser emitter LED enclosed in a cylindrical M18 housing
- Sensing distance up to 35 m
- Fast response time
- Straight or right-angle housing
- Durable metal housing
- IP 67
- Small visible light spot to detect small objects
- Laser class 1

Your benefits

- Lowest-cost laser sensor in M18 cylindrical housing saves installation costs
- Time saving installation and alignment with highly visible light spot
- Laser class 1 does not require increased safety measures or markings, reducing installation costs
- Fast response time ensures reliable object detection at high speeds and increases machine throughput
- Polarizing filter prevents false readings on reflective surfaces, reducing downtime



Features

Sensor/detection principle:	Photoelectric retro-reflective sensor, Standard optics
Housing design (light emission):	Cylindrical, angled, straight
Housing length:	107.7 mm
Thread diameter (housing):	M18 x 1
Optical axis:	radial
Sensing range max.:	0.1 m ... 35 m ¹⁾
Sensing range:	0.1 m ... 30 m ²⁾
Type of light:	Visible red light
Light source:	Laser ³⁾
Light spot (distance):	9 mm (35 m)
Laser class:	1 (IEC 60825-1)
Wave length:	650 nm
Sensitivity adjustment:	Electronic, via control input C (0 V) manual, via teach-in button
Angle of dispersion:	0.04 °

^{1) 2)} P250F ³⁾ Average service life of 100,000 h at T_A = +25 °C

Mechanics/electronics

Supply voltage:	10 V DC ... 30 V DC ¹⁾
Residual ripple:	≤ 10 % ²⁾
Power consumption:	≤ 20 mA ³⁾
Output type:	NPN, Light/dark-switching, Selectable via control input C
Output current I _{max.} :	≤ 100 mA
Response time:	≤ 0.625 ms ⁴⁾
Switching frequency:	800 Hz ⁵⁾
Electrical connection:	Connector M12, 4-pin
Circuit protection::::	A, B, C, D ^{6) 7) 8) 9)}
Protection class:	III
Weight:	60 g
Polarisation filter:	✓
Housing material:	Nickel-plated brass/PC
Optics material:	PC with protective glass pane
Enclosure rating:	IP 67
Ambient temperature operation:	-15 °C ... 55 °C
Ambient storage temperature:	-25 °C ... 70 °C
UL File-No.:	UL No. NRKH.E181493, CDRH-Konform (0312012-00)

¹⁾ Limit values ²⁾ May not exceed or fall short of V_S tolerances ³⁾ Without load ⁴⁾ Signal transit time with resistive load ⁵⁾ With light/dark ratio 1:1 ⁶⁾ A = V_S
connections reverse-polarity protected ⁷⁾ B = interference suppression ⁸⁾ D = outputs overcurrent and short-circuit protected ⁹⁾ D = inputs and output reverse-polarity
protected

Dimensional drawing

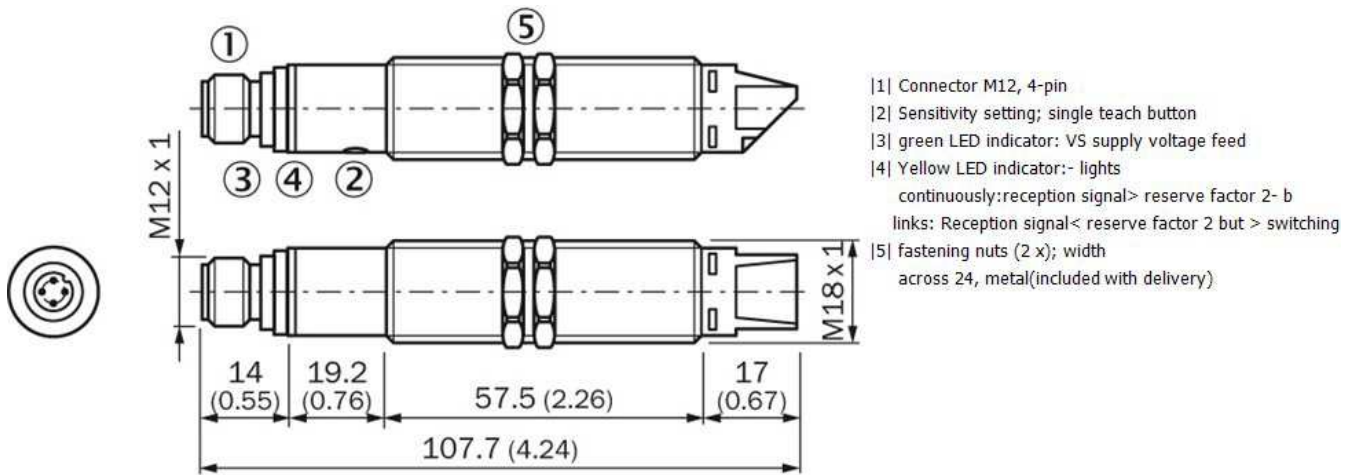

Adjustments possible

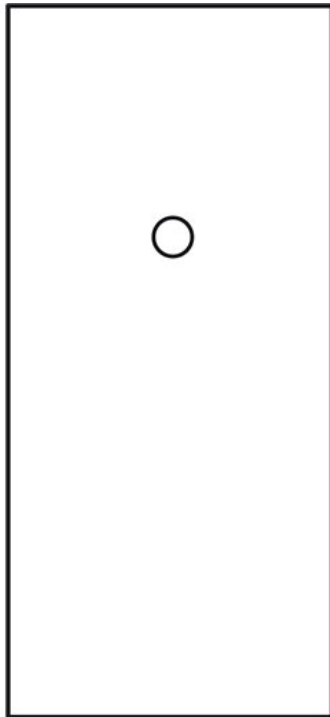

Connection diagram

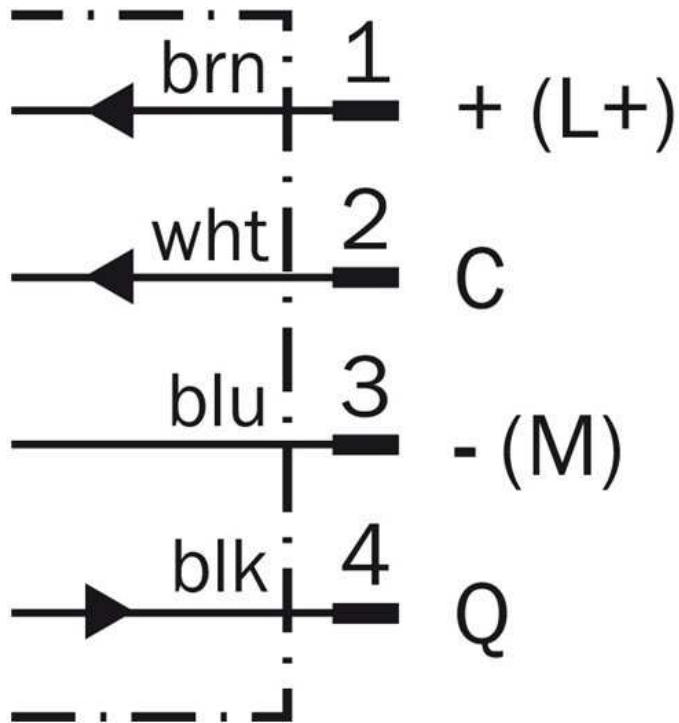

Characteristic curve

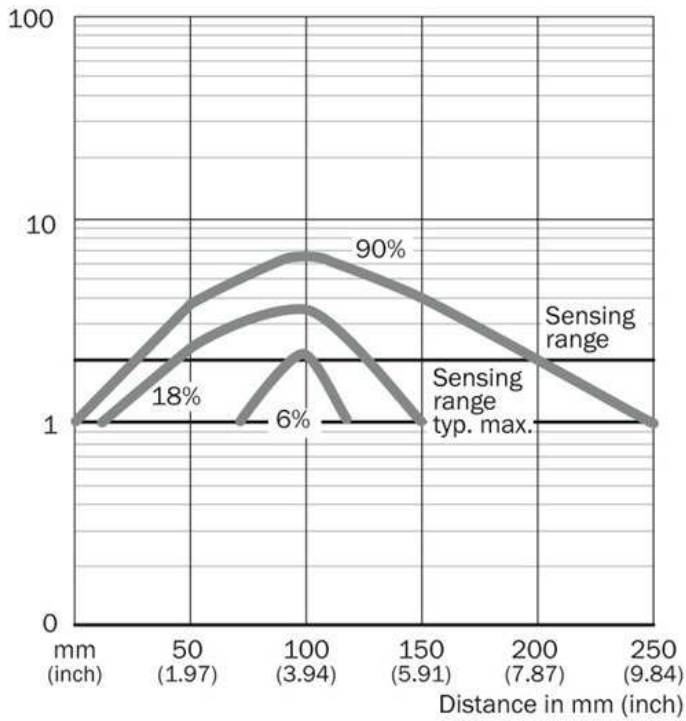

Characteristic curve

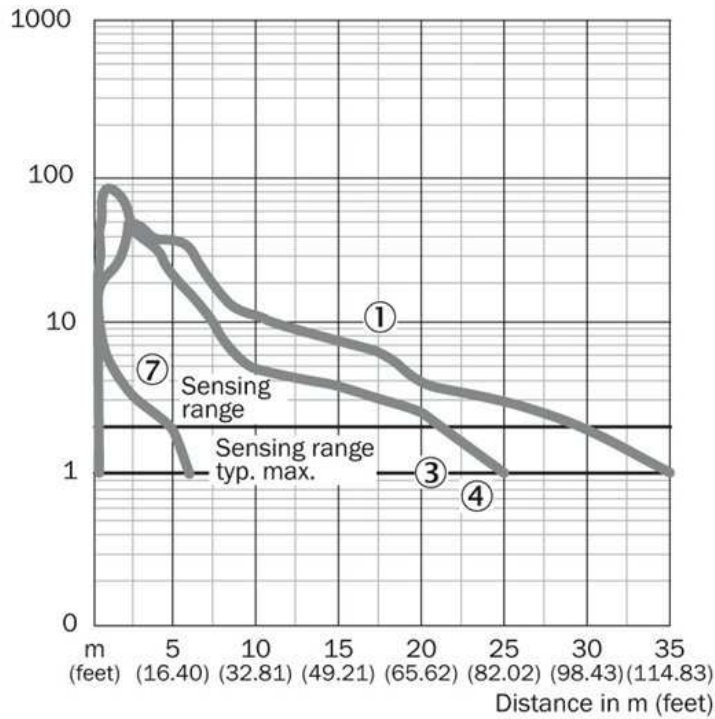

Sensing range diagram

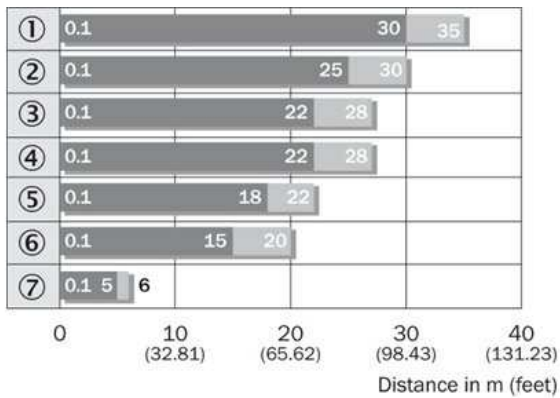

■ Operating range ■ Scanning range typ. max.

Reflector type	Operating range
① P250F	0.1 (.33) ... 30 (131.23)
② PL10F	0.1 (.33) ... 25 (82.02)
③ PL80A	0.1 (.33) ... 22 (72.18)
④ P 250	0.1 (.33) ... 22 (72.18)
⑤ C110	0.1 (.33) ... 18 (59.06)
⑥ PL10F	0.1 (.33) ... 15 (49.21)
⑦ Reflective tape „Diamond Grade“	0.1 (.33) ... 5 (16.4)

Connection type



Light spot size

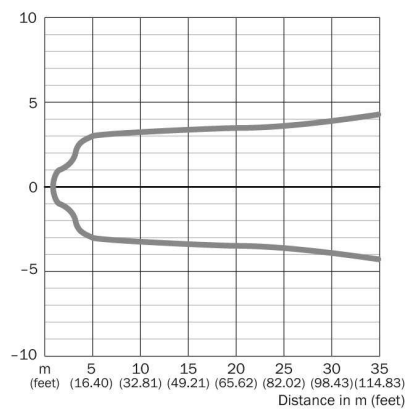

Australia

Phone +61 3 9457 0600
1800 33 48 02 – tollfree
E-Mail sales@sick.com.au

Belgium/Luxembourg

Phone +32 (0)2 466 55 66
E-Mail info@sick.be

Brasil

Phone +55 11 3215-4900
E-Mail marketing@sick.com.br

Canada

Phone +1 905 771 14 44
E-Mail information@sick.com

Česká republika

Phone +420 2 57 91 18 50
E-Mail sick@sick.cz

China

Phone +86 4000 121 000
E-Mail info.china@sick.net.cn
Phone +852-2153 6300
E-Mail ghk@sick.com.hk

Danmark

Phone +45 45 82 64 00
E-Mail sick@sick.dk

Deutschland

Phone +49 211 5301-301
E-Mail info@sick.de

España

Phone +34 93 480 31 00
E-Mail info@sick.es

France

Phone +33 1 64 62 35 00
E-Mail info@sick.fr

Great Britain

Phone +44 (0)1727 831121
E-Mail info@sick.co.uk

India

Phone +91-22-4033 8333
E-Mail info@sick-india.com

Israel

Phone +972-4-6881000
E-Mail info@sick-sensors.com

Italia

Phone +39 02 27 43 41
E-Mail info@sick.it

Japan

Phone +81 (0)3 5309 2112
E-Mail support@sick.jp

Magyarország

Phone +36 1 371 2680
E-Mail office@sick.hu

Nederland

Phone +31 (0)30 229 25 44
E-Mail info@sick.nl

Norge

Phone +47 67 81 50 00
E-Mail sick@sick.no

Österreich

Phone +43 (0)22 36 62 28 8-0
E-Mail office@sick.at

Polska

Phone +48 22 837 40 50
E-Mail info@sick.pl

România

Phone +40 356 171 120
E-Mail office@sick.ro

Russia

Phone +7-495-775-05-30
E-Mail info@sick.ru

Schweiz

Phone +41 41 619 29 39
E-Mail contact@sick.ch

Singapore

Phone +65 6744 3732
E-Mail sales.gsg@sick.com

Slovenija

Phone +386 (0)1-47 69 990
E-Mail office@sick.si

South Africa

Phone +27 11 472 3733
E-Mail info@sickautomation.co.za

South Korea

Phone +82 2 786 6321/4
E-Mail info@sickkorea.net

Suomi

Phone +358-9-25 15 800
E-Mail sick@sick.fi

Sverige

Phone +46 10 110 10 00
E-Mail info@sick.se

Taiwan

Phone +886 2 2375-6288
E-Mail sales@sick.com.tw

Türkiye

Phone +90 (216) 528 50 00
E-Mail info@sick.com.tr

United Arab Emirates

Phone +971 (0) 4 88 65 878
E-Mail info@sick.ae

USA/México

Phone +1(952) 941-6780
1 (800) 325-7425 – tollfree
E-Mail info@sickusa.com

More representatives and agencies
at www.sick.com