



Plug connectors and cables
Plug connectors and cables / connecting cables
with female connector

DOL-1204-L05MN



Plug connectors and cables
Plug connectors and cables / connecting cables with female connector

Model Name > [DOL-1204-L05MN](#)
Part No. > [6028137](#)



Technical data

Accessory group:	Plug connectors and cables
Accessory family:	Connecting cables with female connector
Application:	Hygienic systems
Connection type head A:	Female connector, M12, 4-pin, angled, with 3 LEDs
Connection type head B:	Cable
Connection type:	Open conductor heads
Locking nut material:	Stainless steel (V4A/1.4404/316L)
Cable diameter:	Ø 5 mm
Conductor cross-section:	0.25 mm ²
Shielding:	Unshielded
Bending radius:	> 10 x cable diameter flexible use, > 5 x cable diameter (stationary position)
Biegezyklen:	> 1,000,000
Tightening torque:	≤ 60 Ncm
Status LED:	✓
Reference voltage:	250 V
Current loading:	4 A
Special feature:	Drag chain use
Ambient operating temperature:	+5 °C ... +80 °C, cable, flexible use -25 °C ... +70 °C, male connector -40 °C ... +80 °C, cable, stationary position
Enclosure rating:	IP 67 IP 69K
Connector material:	PVC
Connector color:	Orange
Cable:	5 m, 4-wire
Jacket material:	PVC
Jacket color:	Orange

Dimensional drawing

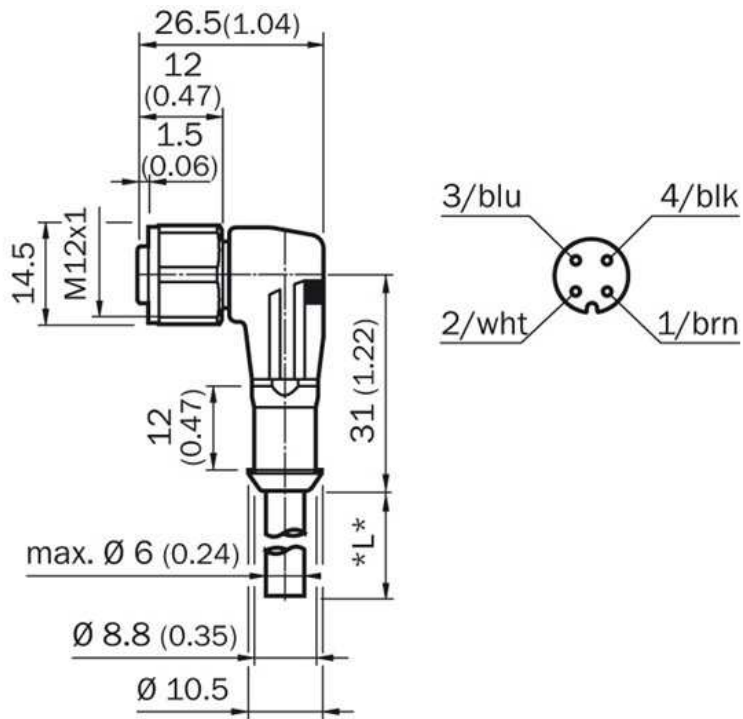

Australia

Phone +61 3 9457 0600
1800 33 48 02 – tollfree
E-Mail sales@sick.com.au

Belgium/Luxembourg

Phone +32 (0)2 466 55 66
E-Mail info@sick.be

Brasil

Phone +55 11 3215-4900
E-Mail marketing@sick.com.br

Canada

Phone +1 905 771 14 44
E-Mail information@sick.com

Česká republika

Phone +420 2 57 91 18 50
E-Mail sick@sick.cz

China

Phone +86 4000 121 000
E-Mail info.china@sick.net.cn
Phone +852-2153 6300
E-Mail ghk@sick.com.hk

Danmark

Phone +45 45 82 64 00
E-Mail sick@sick.dk

Deutschland

Phone +49 211 5301-301
E-Mail info@sick.de

España

Phone +34 93 480 31 00
E-Mail info@sick.es

France

Phone +33 1 64 62 35 00
E-Mail info@sick.fr

Great Britain

Phone +44 (0)1727 831121
E-Mail info@sick.co.uk

India

Phone +91-22-4033 8333
E-Mail info@sick-india.com

Israel

Phone +972-4-6881000
E-Mail info@sick-sensors.com

Italia

Phone +39 02 27 43 41
E-Mail info@sick.it

Japan

Phone +81 (0)3 5309 2112
E-Mail support@sick.jp

Magyarország

Phone +36 1 371 2680
E-Mail office@sick.hu

Nederland

Phone +31 (0)30 229 25 44
E-Mail info@sick.nl

Norge

Phone +47 67 81 50 00
E-Mail sick@sick.no

Österreich

Phone +43 (0)22 36 62 28 8-0
E-Mail office@sick.at

Polska

Phone +48 22 837 40 50
E-Mail info@sick.pl

România

Phone +40 356 171 120
E-Mail office@sick.ro

Russia

Phone +7-495-775-05-30
E-Mail info@sick.ru

Schweiz

Phone +41 41 619 29 39
E-Mail contact@sick.ch

Singapore

Phone +65 6744 3732
E-Mail sales.gsg@sick.com

Slovenija

Phone +386 (0)1-47 69 990
E-Mail office@sick.si

South Africa

Phone +27 11 472 3733
E-Mail info@sickautomation.co.za

South Korea

Phone +82 2 786 6321/4
E-Mail info@sickkorea.net

Suomi

Phone +358-9-25 15 800
E-Mail sick@sick.fi

Sverige

Phone +46 10 110 10 00
E-Mail info@sick.se

Taiwan

Phone +886 2 2375-6288
E-Mail sales@sick.com.tw

Türkiye

Phone +90 (216) 528 50 00
E-Mail info@sick.com.tr

United Arab Emirates

Phone +971 (0) 4 88 65 878
E-Mail info@sick.ae

USA/México

Phone +1(952) 941-6780
1 (800) 325-7425 – tollfree
E-Mail info@sickusa.com

More representatives and agencies
at www.sick.com