



Ultrasonic sensors UC12

UC12-12231



Model Name > UC12-12231
Part No. > 6029832



At a glance

- Object detection independent of material color and ambient light - even transparent foils, glass, liquids and bottles are reliably detected
- Fast and easy teach-in with single push-button
- Immune to dirt, dust and fog
- Two ambivalent switching outputs (Q, /Q)
- Excellent background suppression
- Three operation modes: Distance to Object (DtO), Window (Wnd) or Object between sensor and background (ObSB)

Your benefits

- Fast commissioning due to single-button teach-in
- Full mechanical compatibility to photoelectric sensors increase application flexibility without machine modification
- Standard proximity, window and reflection modes provide application flexibility, which increases reliability and productivity
- Integrated temperature compensation ensures high measurement accuracy
- Complementary switching outputs immediately signal broken wiring, reducing faulty production results

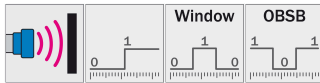

Performance

Resolution:	≥ 0.1 mm
Working range, limiting range:	55 mm ... 250 mm, 350 mm
Repeatability ¹⁾ :	± 0.15 %
Accuracy ²⁾ :	± 1 %
Response time:	30 ms
Switching frequency:	25 Hz
Ultrasonic frequency (typical):	500 kHz
Detection area (typical):	See diagrams
Temperature compensation:	✓
Additional function:	Set switching mode: Distance to object (DtO)/switching window (Wnd)/ Object Between Sensor and Background (ObSB) Teach-in of switching output Temperature compensation Reset to factory default Lock user interface
Output time:	8 ms

1) 2) Referring to current measurement value

Interfaces

Output type ^{1), 2), 3)}: 2 x PNP (500 mA)
Hysteresis: 2 mm

¹⁾ Output Q short-circuit protected ²⁾ Complementary switching outputs (Q, /Q) ³⁾ PNP: HIGH = $V_S - (< 2 V)$ /LOW = 0 V

Mechanics/electronics

Sending axis: Straight
Supply voltage V_S ¹⁾: DC 10 V ... 30 V
Power consumption ²⁾: $\leq 1.2 W$
Initialization time: $< 300 ms$
Design: Rectangular
Housing material: Die-cast zinc
ultrasonic transducer: polyurethane foam, glass epoxy resin
Electrical connection: Male connector, M12, 4-pin
Indication: Dual LED
Weight: 75 g

¹⁾ Limit values, reverse-polarity protected, operation in short-circuit protected network: max. 8 A ²⁾ Without load

Ambient data

Enclosure rating: IP 67
Protection class: III
Ambient temperature: Operation: -25 ... +70 °C
Storage: -40 ... +85 °C

Dimensional drawing

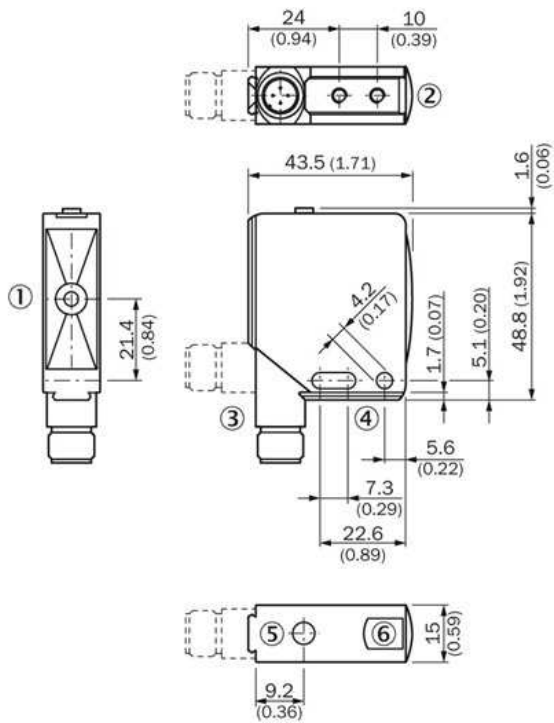

- |1| Transmission and reception axis
- |2| M4 threaded mounting hole, 4 mm deep
- |3| Connection
- |4| Mounting hole
- |5| Control elements
- |6| Status indicator switching
output (orange) and power on (green)

Adjustments

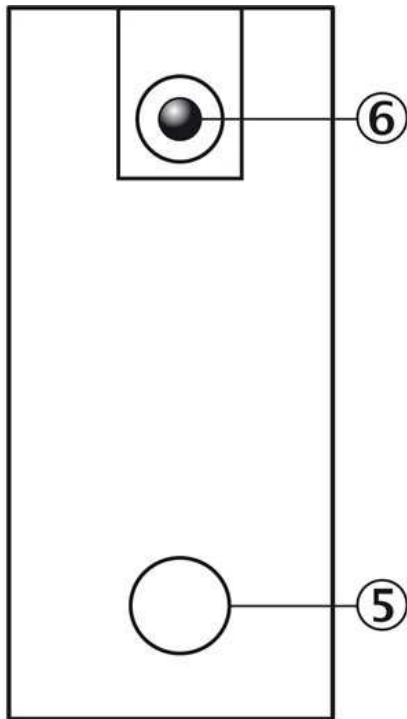

- |5| Control elements
- |6| Status indicator switching
output (orange) and power on (green)

Connection type

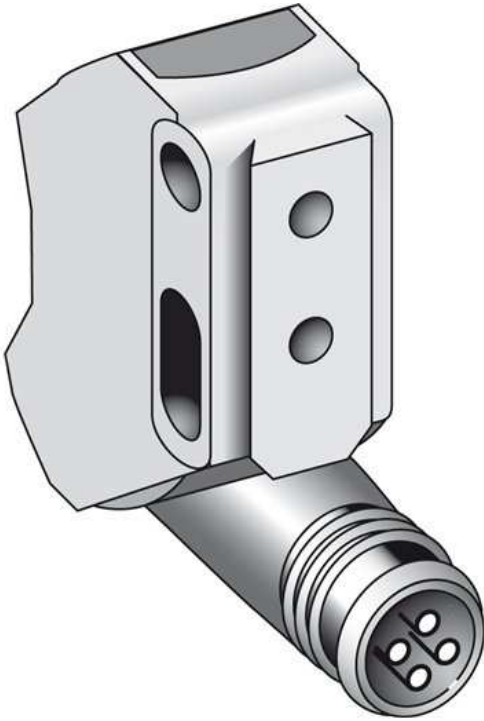

Connection diagram

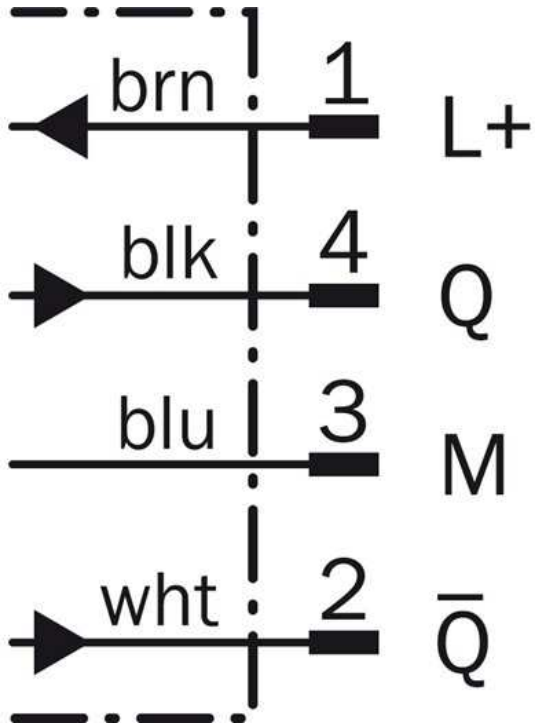

Detection area

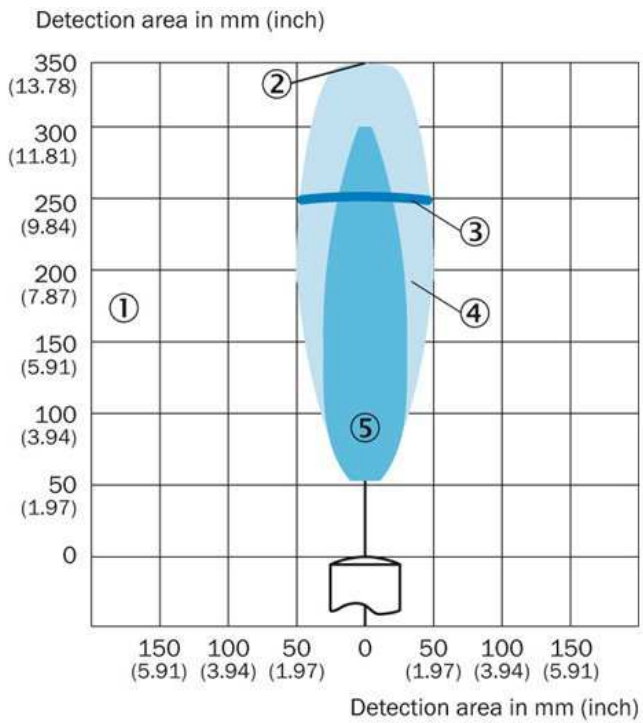

- |1| Sensing range dependent on reflection properties, size and orientation of the object
- |2| Limiting range
- |3| Working range
- |4| example object: aligned plate 10 mm x 10 mm
- |5| example object: pipe with 10 mm diameter

Australia

Phone +61 3 9457 0600
1800 33 48 02 – tollfree
E-Mail sales@sick.com.au

Belgium/Luxembourg

Phone +32 (0)2 466 55 66
E-Mail info@sick.be

Brasil

Phone +55 11 3215-4900
E-Mail marketing@sick.com.br

Canada

Phone +1 905 771 14 44
E-Mail information@sick.com

Česká republika

Phone +420 2 57 91 18 50
E-Mail sick@sick.cz

China

Phone +86 4000 121 000
E-Mail info.china@sick.net.cn
Phone +852-2153 6300
E-Mail ghk@sick.com.hk

Danmark

Phone +45 45 82 64 00
E-Mail sick@sick.dk

Deutschland

Phone +49 211 5301-301
E-Mail info@sick.de

España

Phone +34 93 480 31 00
E-Mail info@sick.es

France

Phone +33 1 64 62 35 00
E-Mail info@sick.fr

Great Britain

Phone +44 (0)1727 831121
E-Mail info@sick.co.uk

India

Phone +91-22-4033 8333
E-Mail info@sick-india.com

Israel

Phone +972-4-6881000
E-Mail info@sick-sensors.com

Italia

Phone +39 02 27 43 41
E-Mail info@sick.it

Japan

Phone +81 (0)3 5309 2112
E-Mail support@sick.jp

Magyarország

Phone +36 1 371 2680
E-Mail office@sick.hu

Nederland

Phone +31 (0)30 229 25 44
E-Mail info@sick.nl

Norge

Phone +47 67 81 50 00
E-Mail sick@sick.no

Österreich

Phone +43 (0)22 36 62 28 8-0
E-Mail office@sick.at

Polska

Phone +48 22 837 40 50
E-Mail info@sick.pl

România

Phone +40 356 171 120
E-Mail office@sick.ro

Russia

Phone +7-495-775-05-30
E-Mail info@sick.ru

Schweiz

Phone +41 41 619 29 39
E-Mail contact@sick.ch

Singapore

Phone +65 6744 3732
E-Mail sales.gsg@sick.com

Slovenija

Phone +386 (0)1-47 69 990
E-Mail office@sick.si

South Africa

Phone +27 11 472 3733
E-Mail info@sickautomation.co.za

South Korea

Phone +82 2 786 6321/4
E-Mail info@sickkorea.net

Suomi

Phone +358-9-25 15 800
E-Mail sick@sick.fi

Sverige

Phone +46 10 110 10 00
E-Mail info@sick.se

Taiwan

Phone +886 2 2375-6288
E-Mail sales@sick.com.tw

Türkiye

Phone +90 (216) 528 50 00
E-Mail info@sick.com.tr

United Arab Emirates

Phone +971 (0) 4 88 65 878
E-Mail info@sick.ae

USA/México

Phone +1(952) 941-6780
1 (800) 325-7425 – tollfree
E-Mail info@sickusa.com

More representatives and agencies
at www.sick.com