



Photoelectric sensors
W100 Laser, Through-beam photoelectric sensor

WS/WE100L-E1131



Model Name > [WS/WE100L-E1131](#)
Part No. > [6030717](#)



Illustration may differ

At a glance

- Standard miniature housing with M3 threaded mounting holes
- Laser emitter LED, class 1
- Switching frequency of 2000 Hz
- Light/dark switching via rotary switch

Your benefits

- Laser light spot combined with 2 kHz switching frequency ensures reliable detection of small objects, even at fast detection speeds
- Less contamination due to high optical operating reserve
- M3 threaded mounting holes provide easy installation



Features

Sensor/detection principle:	Through-beam photoelectric sensor
Dimensions (W x H x D):	11 mm x 31 mm x 20 mm
Housing design (light emission):	Rectangular
Sensing range max.:	0 m ... 35 m
Sensing range:	0 m ... 30 m
Type of light:	Visible red light
Light source:	Laser ¹⁾
Laser class:	1
Wave length:	650 nm
Focus adjustable:	-
Adjustment:	Potentiometer, 270 °
Light spot size (distance):	Ø 30 mm (30 m)

¹⁾ Average service life 50,000 h at T_A = +25 °C

Mechanics/electronics

Supply voltage:	10 V DC ... 30 V DC ¹⁾
Residual ripple:	± 10 % ²⁾
Power consumption, sender:	≤ 15 mA ³⁾
Power consumption, receiver:	≤ 20 mA ⁴⁾
Output type:	NPN, open collector
Switching mode:	Light/dark switching
Switching mode selector:	Manually selectable
Signal voltage NPN HIGH/LOW:	Approx. VS / < 1.8 V

Output current I _{max} :	100
Response time:	< 0.25 ms ⁵⁾
Switching frequency:	2,000 ⁶⁾
Electrical connection:	Cable, 3-wire, 2 m ⁷⁾
Cable material:	PVC
Conductor cross-section:	0.18 mm ²
Circuit protection:::	A, B, D ^{8) 9) 10)}
Weight:	50 g
Housing material:	ABS/PC/POM, Plastic
Optics material:	PMMA
Enclosure rating:	IP 65
Items supplied:	2 Stainless steel mounting brackets (1.4301/304) BEF-W100-A
Ambient temperature operation:	-10 °C ... 50 °C
Ambient storage temperature:	-40 °C ... 70 °C
UL File No.:	CDRH-conform

1) Limit values, operation in short-circuit protected network max. 8 A resistive load⁶⁾ With light/dark ratio 1:1⁷⁾ Do not bend below 0 °C⁸⁾ A = V_S connections reverse-polarity protected⁹⁾ B = inputs and output reverse-polarity protected¹⁰⁾ D = outputs overcurrent and short-circuit protected

2) May not exceed or fall short of V_S tolerances^{3) 4)} Without load⁵⁾ Signal transit time with

Dimensional drawing

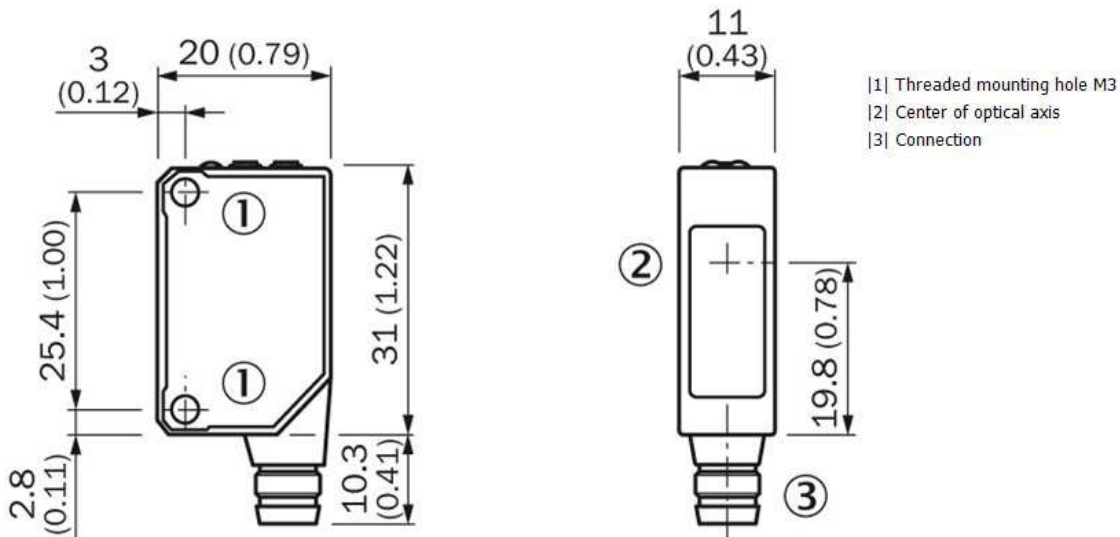

Adjustments possible

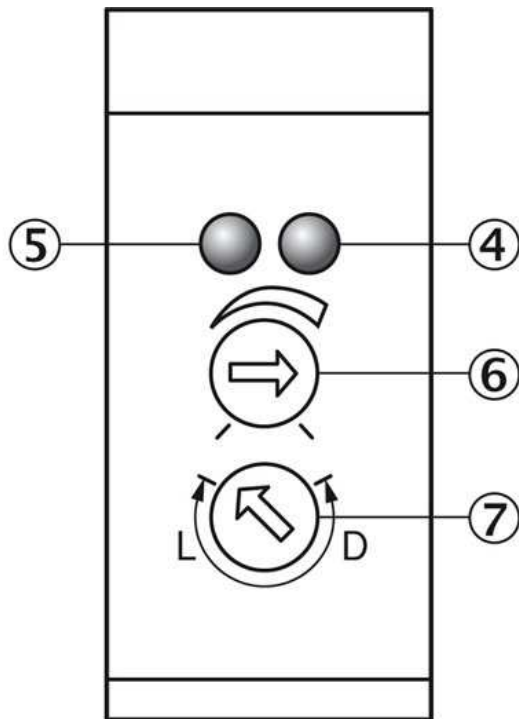

- |4| Orange LED indicator : switching output active
- |5| LED signal strength indicator green:power on
- |6| Sensitivity adjustment 270°
- |7| Light/ dark rotary switch L =
light switching, D = dark switching

Connection diagram

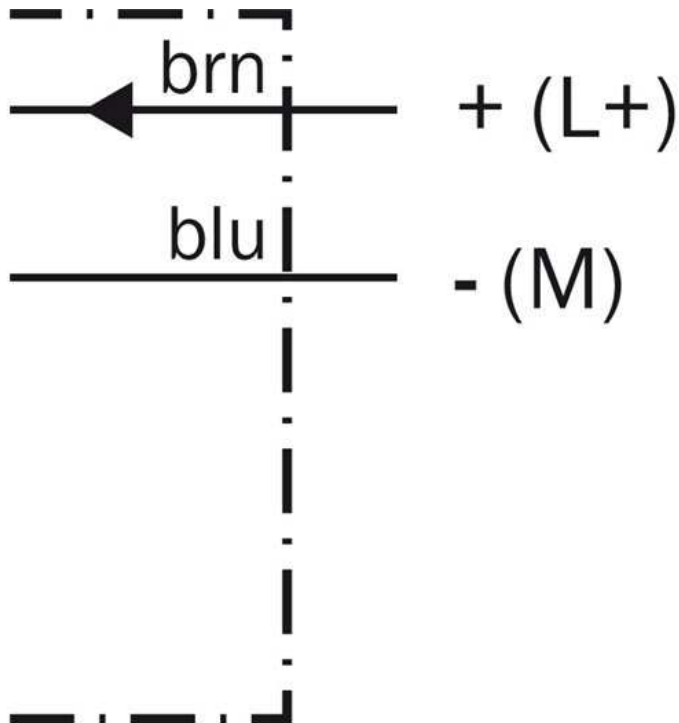

Characteristic curve

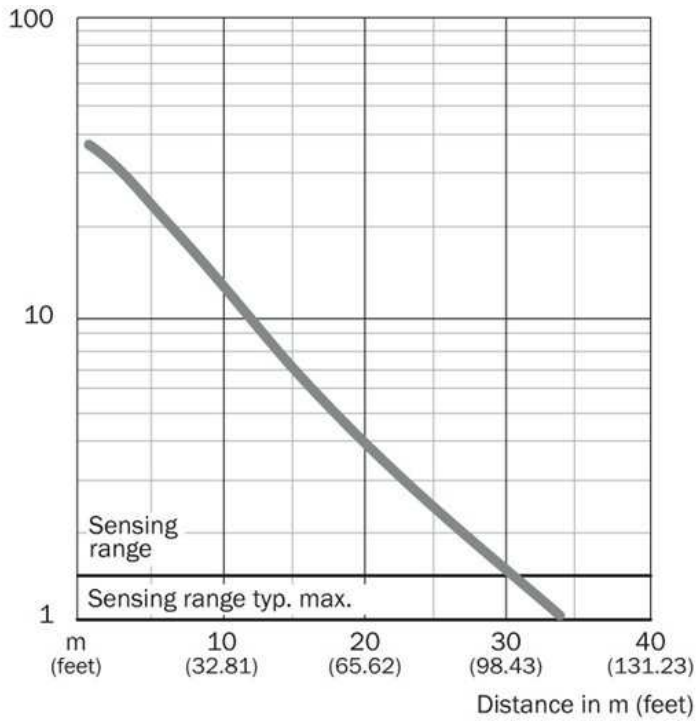

Sensing range diagram

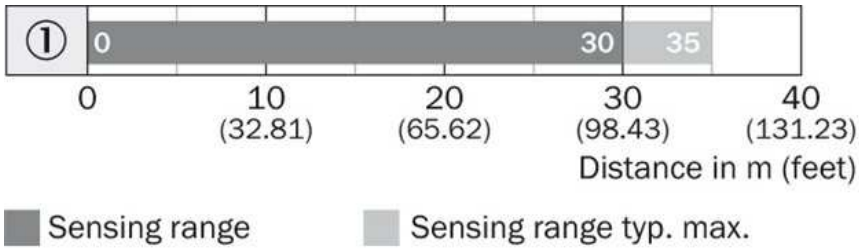

Connection type

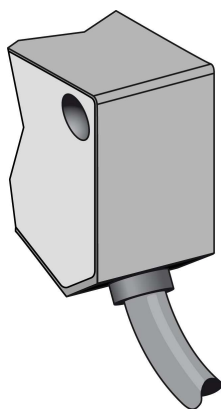

Light spot size

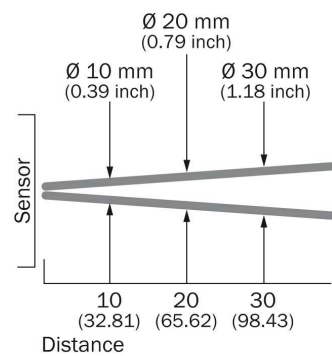

All dimensions in m (feet)

Australia

Phone +61 3 9457 0600
1800 33 48 02 – tollfree
E-Mail sales@sick.com.au

Belgium/Luxembourg

Phone +32 (0)2 466 55 66
E-Mail info@sick.be

Brasil

Phone +55 11 3215-4900
E-Mail marketing@sick.com.br

Canada

Phone +1 905 771 14 44
E-Mail information@sick.com

Česká republika

Phone +420 2 57 91 18 50
E-Mail sick@sick.cz

China

Phone +86 4000 121 000
E-Mail info.china@sick.net.cn
Phone +852-2153 6300
E-Mail ghk@sick.com.hk

Danmark

Phone +45 45 82 64 00
E-Mail sick@sick.dk

Deutschland

Phone +49 211 5301-301
E-Mail info@sick.de

España

Phone +34 93 480 31 00
E-Mail info@sick.es

France

Phone +33 1 64 62 35 00
E-Mail info@sick.fr

Great Britain

Phone +44 (0)1727 831121
E-Mail info@sick.co.uk

India

Phone +91-22-4033 8333
E-Mail info@sick-india.com

Israel

Phone +972-4-6881000
E-Mail info@sick-sensors.com

Italia

Phone +39 02 27 43 41
E-Mail info@sick.it

Japan

Phone +81 (0)3 5309 2112
E-Mail support@sick.jp

Magyarország

Phone +36 1 371 2680
E-Mail office@sick.hu

Nederland

Phone +31 (0)30 229 25 44
E-Mail info@sick.nl

Norge

Phone +47 67 81 50 00
E-Mail sick@sick.no

Österreich

Phone +43 (0)22 36 62 28 8-0
E-Mail office@sick.at

Polska

Phone +48 22 837 40 50
E-Mail info@sick.pl

România

Phone +40 356 171 120
E-Mail office@sick.ro

Russia

Phone +7-495-775-05-30
E-Mail info@sick.ru

Schweiz

Phone +41 41 619 29 39
E-Mail contact@sick.ch

Singapore

Phone +65 6744 3732
E-Mail sales.gsg@sick.com

Slovenija

Phone +386 (0)1-47 69 990
E-Mail office@sick.si

South Africa

Phone +27 11 472 3733
E-Mail info@sickautomation.co.za

South Korea

Phone +82 2 786 6321/4
E-Mail info@sickkorea.net

Suomi

Phone +358-9-25 15 800
E-Mail sick@sick.fi

Sverige

Phone +46 10 110 10 00
E-Mail info@sick.se

Taiwan

Phone +886 2 2375-6288
E-Mail sales@sick.com.tw

Türkiye

Phone +90 (216) 528 50 00
E-Mail info@sick.com.tr

United Arab Emirates

Phone +971 (0) 4 88 65 878
E-Mail info@sick.ae

USA/México

Phone +1(952) 941-6780
1 (800) 325-7425 – tollfree
E-Mail info@sickusa.com

More representatives and agencies
at www.sick.com