



Inductive proximity sensors  
Cylindrical threaded housing, IMF18

IMF18-08NNPVCOS



**Model Name** > IMF18-08NNPVC0S  
**Part No.** > 6035226



**At a glance**

- Size M18
- Extremely watertight (IP 68/IP 69K)
- Extended temperature range (-40 to +80 °C). Tolerates short-term temperature increases up to 100 °C
- Stainless steel housing (316L/1.4404)
- Front cap made of PPS (FDA-certified material)
- Resistant to industrial cleaning agents, ECOLAB and JohnsonDiversey certified

**Your benefits**

- Reduced machine downtime
- Hygienic process due to FDA approved material and hygienic design
- Reduced maintenance costs due to sensor's resistance to aggressive cleaning cycles
- No restrictions on cleaning agents or processes, ensuring reliable operation



**Features**

Design:	Cylindrical
Thread size:	M18 x 1
Sensing range Sn:	8 mm
Assured sensing range Sa:	6.48 mm
Installation type:	Non-flush
Switching frequency:	1,500 Hz
Output type:	NPN
Output function:	Complementary
Electrical wiring:	DC 4-wire
Enclosure rating::	IP 68, IP 69K <sup>1) 2)</sup>
Electrical connection:	Connector M12, 4-pin <sup>3)</sup>

<sup>1)</sup> According to EN 60529 <sup>2)</sup> According to EN40050 <sup>3)</sup> With gold plated contact pins

**Mechanics/electronics**

Supply voltage:	10 V ... 30 V
Residual ripple:	≤ 10 %
Voltage drop:	≤ 2 V
Power consumption:	≤ 15 mA <sup>1)</sup>
Time delay before availability:	Ca. 50 ms

Hysteresis:	1 % ... 20 %
Repeatability:	5 % <sup>2) 3)</sup>
Temperature drift (of Sr):	± 10 %
EMC:	According to EN 60947-5-2
Output current I <sub>a</sub> :	≤ 200 mA
Short-circuit protection:	✓
Reverse polarity protection:	✓
Power-up pulse protection:	✓
Shock and vibration resistance:	30 g, 11 ms/10 Hz ... 55 Hz, 1 mm
Ambient temperature operation:	-40 °C ... 80 °C <sup>4)</sup>
Housing material:	Stainless steel, Stainless steel V4A (1.4404, 316L)
Housing cap material:	PPS
Housing length:	63 mm
Thread length:	27 mm
Tightening torque, max.:	50 Nm

1) Without load    2) U<sub>b</sub> and T<sub>a</sub> constant    3) Of Sr    4) +100 °C for 15 minutes

### Reduction factors

---

Note:	The values are reference values which may vary
Stainless steel (V2A, 304):	Ca. 0.7
Copper (Cu):	Ca. 0.27
Aluminum (Al):	Ca. 0.35
Brass (Br):	Ca. 0.42

### Installation note

---

A:	18 mm
B:	36 mm
C:	18 mm
D:	24 mm
E:	12 mm
F:	64 mm
Remark:	Associated graphic see "Installation"

## Installation note



## Dimensional drawing

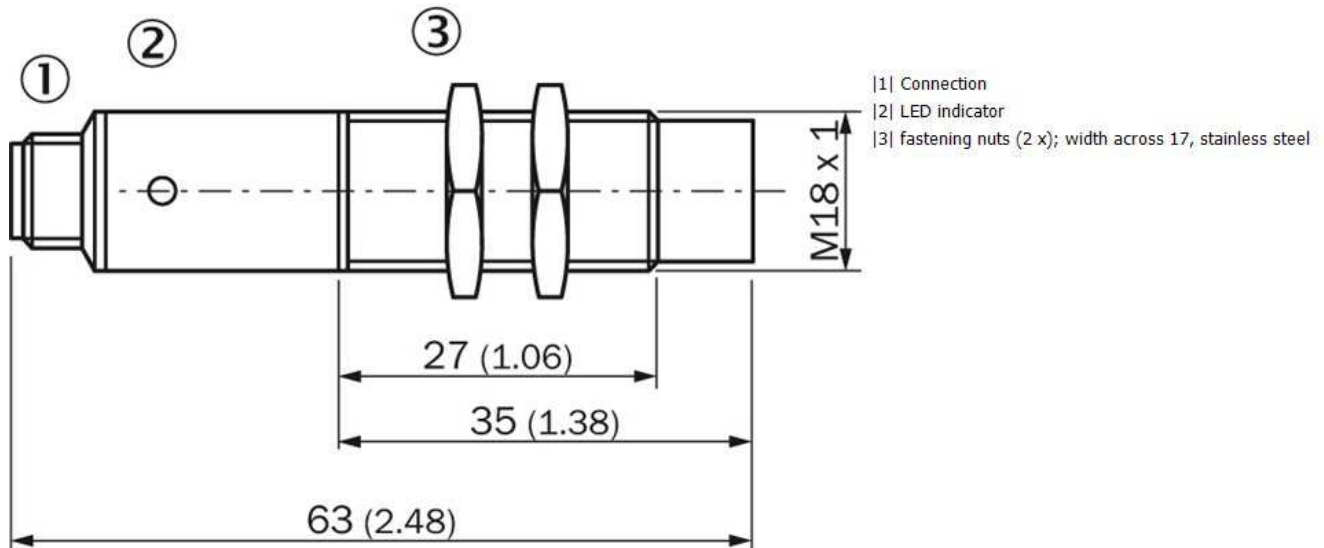

All dimensions in mm (inch)

Connection diagram

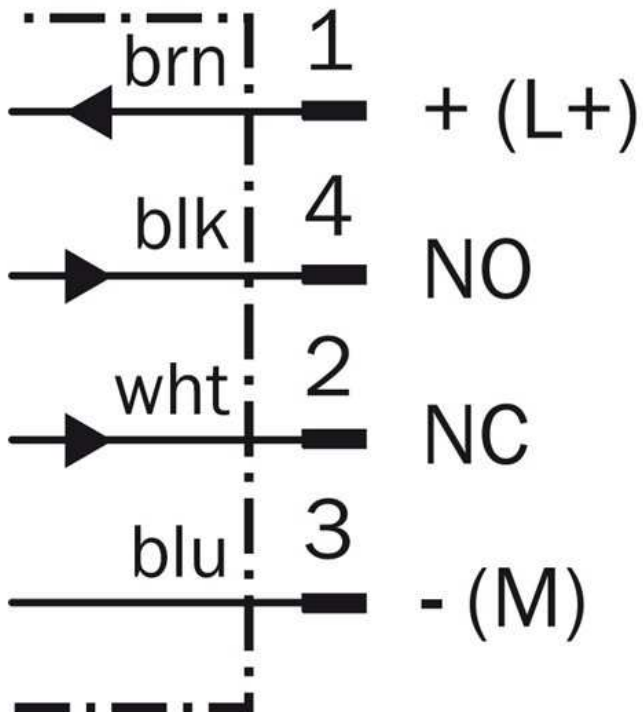

Connection type



**Australia**

Phone +61 3 9457 0600  
1800 33 48 02 – tollfree  
E-Mail sales@sick.com.au

**Belgium/Luxembourg**

Phone +32 (0)2 466 55 66  
E-Mail info@sick.be

**Brasil**

Phone +55 11 3215-4900  
E-Mail marketing@sick.com.br

**Canada**

Phone +1 905 771 14 44  
E-Mail information@sick.com

**Česká republika**

Phone +420 2 57 91 18 50  
E-Mail sick@sick.cz

**China**

Phone +86 4000 121 000  
E-Mail info.china@sick.net.cn  
Phone +852-2153 6300  
E-Mail ghk@sick.com.hk

**Danmark**

Phone +45 45 82 64 00  
E-Mail sick@sick.dk

**Deutschland**

Phone +49 211 5301-301  
E-Mail info@sick.de

**España**

Phone +34 93 480 31 00  
E-Mail info@sick.es

**France**

Phone +33 1 64 62 35 00  
E-Mail info@sick.fr

**Great Britain**

Phone +44 (0)1727 831121  
E-Mail info@sick.co.uk

**India**

Phone +91-22-4033 8333  
E-Mail info@sick-india.com

**Israel**

Phone +972-4-6881000  
E-Mail info@sick-sensors.com

**Italia**

Phone +39 02 27 43 41  
E-Mail info@sick.it

**Japan**

Phone +81 (0)3 5309 2112  
E-Mail support@sick.jp

**Magyarország**

Phone +36 1 371 2680  
E-Mail office@sick.hu

**Nederland**

Phone +31 (0)30 229 25 44  
E-Mail info@sick.nl

**Norge**

Phone +47 67 81 50 00  
E-Mail sick@sick.no

**Österreich**

Phone +43 (0)22 36 62 28 8-0  
E-Mail office@sick.at

**Polska**

Phone +48 22 837 40 50  
E-Mail info@sick.pl

**România**

Phone +40 356 171 120  
E-Mail office@sick.ro

**Russia**

Phone +7-495-775-05-30  
E-Mail info@sick.ru

**Schweiz**

Phone +41 41 619 29 39  
E-Mail contact@sick.ch

**Singapore**

Phone +65 6744 3732  
E-Mail sales.gsg@sick.com

**Slovenija**

Phone +386 (0)1-47 69 990  
E-Mail office@sick.si

**South Africa**

Phone +27 11 472 3733  
E-Mail info@sickautomation.co.za

**South Korea**

Phone +82 2 786 6321/4  
E-Mail info@sickkorea.net

**Suomi**

Phone +358-9-25 15 800  
E-Mail sick@sick.fi

**Sverige**

Phone +46 10 110 10 00  
E-Mail info@sick.se

**Taiwan**

Phone +886 2 2375-6288  
E-Mail sales@sick.com.tw

**Türkiye**

Phone +90 (216) 528 50 00  
E-Mail info@sick.com.tr

**United Arab Emirates**

Phone +971 (0) 4 88 65 878  
E-Mail info@sick.ae

**USA/México**

Phone +1(952) 941-6780  
1 (800) 325-7425 – tollfree  
E-Mail info@sickusa.com

More representatives and agencies  
at [www.sick.com](http://www.sick.com)