



Short range distance sensors (displacement) OD Value

OD2-N85W20A0



Model Name > **OD2-N85W20A0**
Part No. > **6036608**



At a glance

- Several measurement ranges from 26 mm ... 34 mm to 100 mm ... 500 mm
- CMOS receiving element for measurement independent of surface
- Easy, LED-based user and teach-in concept
- Wide range of models and a wide range of standard interfaces
- Laser technology for precise measurement of very small objects
- Compact stand-alone device
- Excellent price-performance ratio

Your benefits

- Reliable measurement independent of surface, minimizes machine downtime
- Extremely simple sensor teach-in makes setup faster and more costeffective
- Minimal space requirements and less wiring due to its compact, standalone design
- Many measurement ranges and output interfaces make it ideal for cost-effective integration into any production environment
- Low investment costs make consistent, regular quality inspection possible
- Non-contact measurement technology from a safe distance allows the inspection to be carried out directly during the production process
- Wear and damage-free inspection, due to non-contact measurement



CE III **CDRH** **RS-422**

Performance

Measuring range:	65 mm ... 105 mm, 6 % ... 90 % remission
Resolution ¹⁾ :	10 µm
Repeatability ^{2), 3), 4), 5)} :	30 µm
Linearity ^{6), 7), 8), 9)} :	± 40 µm
Response time ¹⁰⁾ :	1 ms/10 ms/35 ms
Measuring frequency:	2 kHz
Light source:	Laser, red
Typ. light spot size (distance):	0.8 mm x 1.3 mm (85 mm)
Additional function:	Automatic sensitivity adjustment, Teach-in of switching output, Invertable switching output, Averaging 1 ... 64x, Multifunctional input: laser-off/ external teach-in/trigger, Switching mode: distance to object (DtO), Switching mode: window (Wnd)
Laser class:	2 (EN 60825-1) ¹¹⁾

^{1) 3) 6)} At averaging function medium ²⁾ 6 % ... 90 % remission ⁴⁾ Constant ambient conditions ^{5) 8)} For best performance consider warm up time ≤ 5 minutes ⁷⁾
⁹⁾ Measurement on 90 % remission (ceramic, white) ⁹⁾ When calibrated in the application regularly ¹⁰⁾ Automatic sensitivity adjustment ≤ 4 ms, 6 ms for the models with

measuring range of 100 mm ... 400 mm ¹¹⁾ Wavelength: 655 nm, max. output: 1 mW

Interfaces

Data interface: RS-422
Output type ¹⁾: 1 x NPN (100 mA)
Multifunctional input (MF) ²⁾: 1 x MF

¹⁾ PNP: HIGH = V_S - (< 2 V)/LOW = < 2 V; NPN: HIGH = < 2 V/LOW = V_S ²⁾ MF can be used as laser-off, trigger, external teach-in or deactivated; response time \leq 3 ms

Mechanics/electronics

Electrical connection: Male connector, M12, 8-pin
Supply voltage V_S ¹⁾: DC 12 V ... 24 V
Power consumption ²⁾: \leq 2.88 W
Warm-up time: \leq 5 min
Indication: Distance bar graph, up to 8 status LEDs
Weight: 70 g
Housing material: PBT housing with PMMA lens

¹⁾ DC 12 V (-5 %) ... 24 V (+10 %); DC 18 V (-5 %) ... DC 24 V (+10 %) when using analog voltage output ²⁾ Without load, with current output

Ambient data

Enclosure rating: IP 67
Protection class: III
Ambient temperature: Operation: -10 ... +40 °C, Storage: -20 ... +60 °C
Temperature drift: \pm 0.08 % FS/K (FS = Full Scale = Measuring range of sensor)
Typ. ambient light safety: Artificial light: \leq 3,000 lx
Sunlight: \leq 10,000 lx
Vibration resistance: 10 Hz ... 55 Hz (amplitude 1.5 mm, x-, y-, z-axis 2 hours each)
Shock resistance: 50 G (x-, y-, z-axis 3 times each)
Relative humidity (not condensing): 35 % ... 95 %

Dimensional drawing

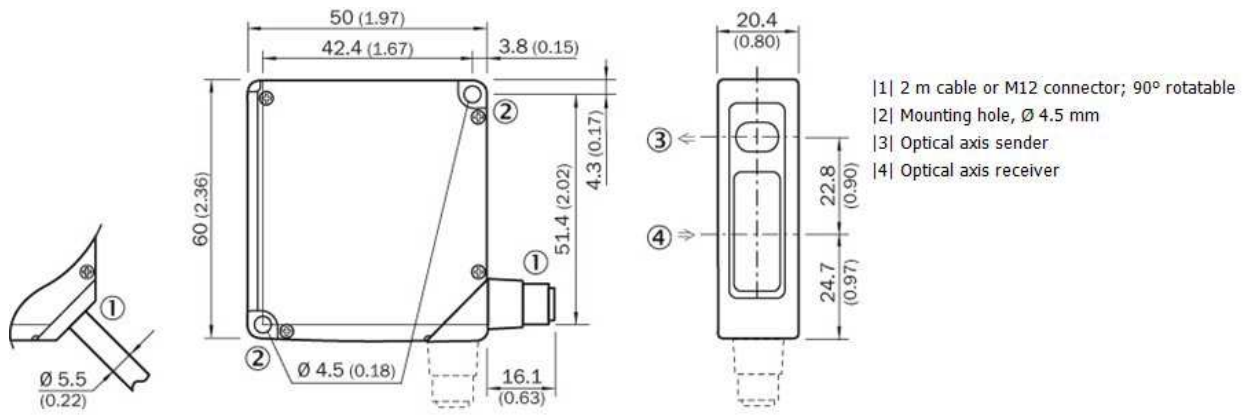

Adjustment possible

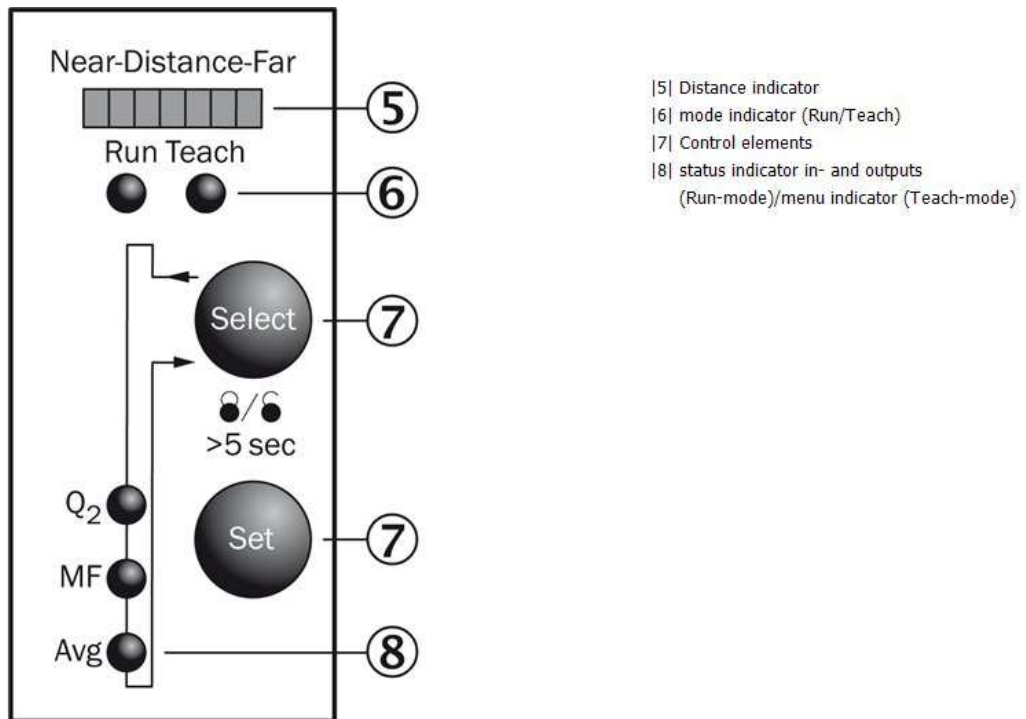

Connection type

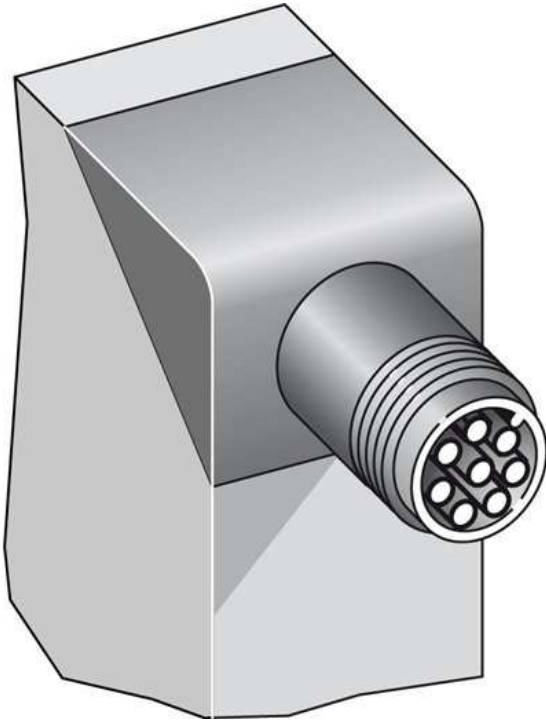

Connection diagram

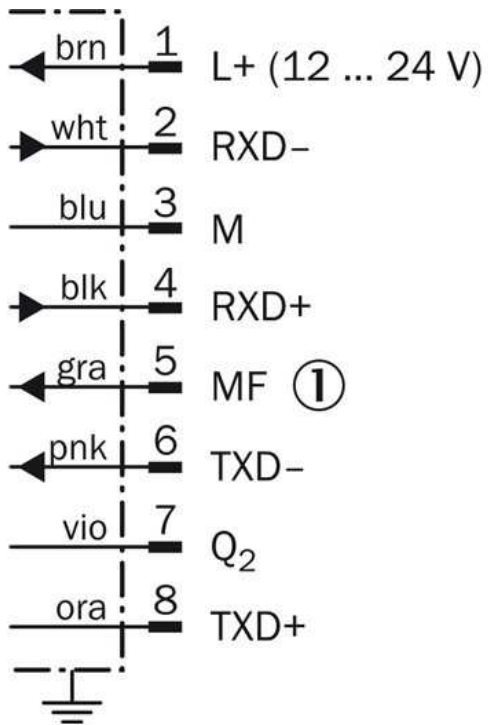

[1] Multifunctional input (MF)

Light spot size

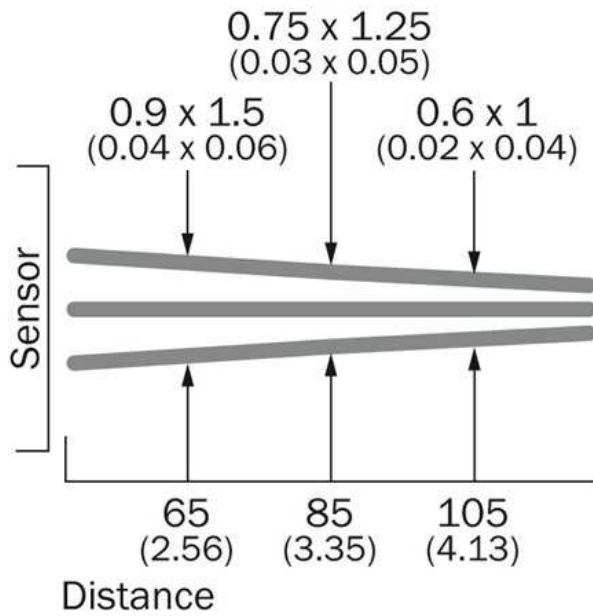

All dimensions in mm (inch)

Linearity

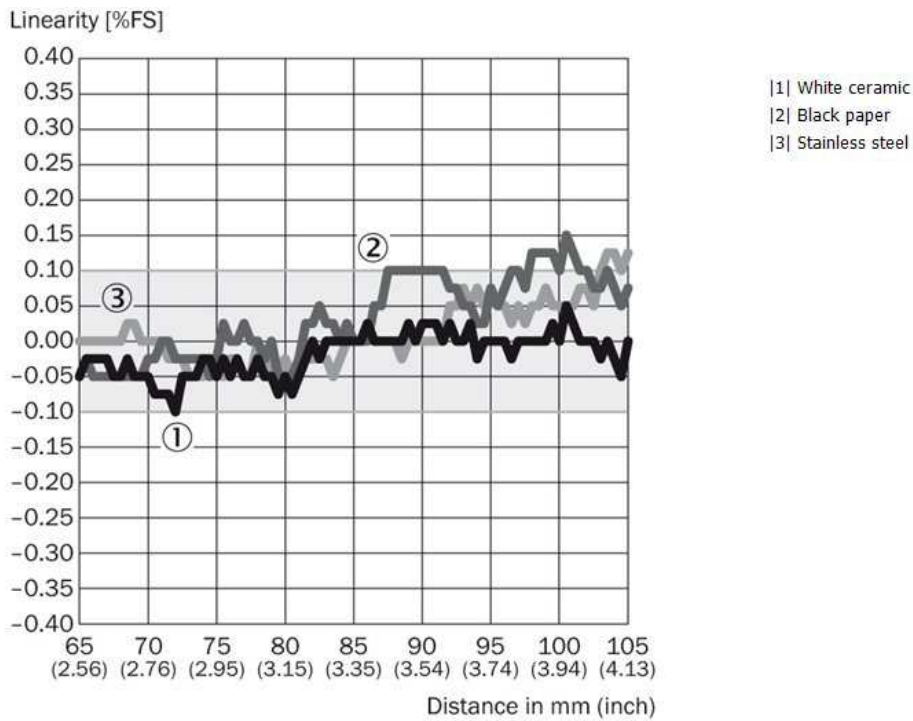

Australia

Phone +61 3 9457 0600
1800 33 48 02 – tollfree
E-Mail sales@sick.com.au

Belgium/Luxembourg

Phone +32 (0)2 466 55 66
E-Mail info@sick.be

Brasil

Phone +55 11 3215-4900
E-Mail marketing@sick.com.br

Canada

Phone +1 905 771 14 44
E-Mail information@sick.com

Česká republika

Phone +420 2 57 91 18 50
E-Mail sick@sick.cz

China

Phone +86 4000 121 000
E-Mail info.china@sick.net.cn
Phone +852-2153 6300
E-Mail ghk@sick.com.hk

Danmark

Phone +45 45 82 64 00
E-Mail sick@sick.dk

Deutschland

Phone +49 211 5301-301
E-Mail info@sick.de

España

Phone +34 93 480 31 00
E-Mail info@sick.es

France

Phone +33 1 64 62 35 00
E-Mail info@sick.fr

Great Britain

Phone +44 (0)1727 831121
E-Mail info@sick.co.uk

India

Phone +91-22-4033 8333
E-Mail info@sick-india.com

Israel

Phone +972-4-6881000
E-Mail info@sick-sensors.com

Italia

Phone +39 02 27 43 41
E-Mail info@sick.it

Japan

Phone +81 (0)3 5309 2112
E-Mail support@sick.jp

Magyarország

Phone +36 1 371 2680
E-Mail office@sick.hu

Nederland

Phone +31 (0)30 229 25 44
E-Mail info@sick.nl

Norge

Phone +47 67 81 50 00
E-Mail sick@sick.no

Österreich

Phone +43 (0)22 36 62 28 8-0
E-Mail office@sick.at

Polska

Phone +48 22 837 40 50
E-Mail info@sick.pl

România

Phone +40 356 171 120
E-Mail office@sick.ro

Russia

Phone +7-495-775-05-30
E-Mail info@sick.ru

Schweiz

Phone +41 41 619 29 39
E-Mail contact@sick.ch

Singapore

Phone +65 6744 3732
E-Mail sales.gsg@sick.com

Slovenija

Phone +386 (0)1-47 69 990
E-Mail office@sick.si

South Africa

Phone +27 11 472 3733
E-Mail info@sickautomation.co.za

South Korea

Phone +82 2 786 6321/4
E-Mail info@sickkorea.net

Suomi

Phone +358-9-25 15 800
E-Mail sick@sick.fi

Sverige

Phone +46 10 110 10 00
E-Mail info@sick.se

Taiwan

Phone +886 2 2375-6288
E-Mail sales@sick.com.tw

Türkiye

Phone +90 (216) 528 50 00
E-Mail info@sick.com.tr

United Arab Emirates

Phone +971 (0) 4 88 65 878
E-Mail info@sick.ae

USA/México

Phone +1(952) 941-6780
1 (800) 325-7425 – tollfree
E-Mail info@sickusa.com

More representatives and agencies
at www.sick.com