



Ultrasonic sensors UM30, UM30-2

UM30-215112



Model Name > [UM30-215112](#)
Part No. > [6037668](#)



At a glance

- Integrated time-of-flight technology detects objects such as glass, liquids and transparent foils, independent of color
- Range up to 8,000 mm
- Display enables fast and flexible sensor adjustment
- Immune to dust, dirt and fog
- Available with combined analog and digital outputs
- Synchronization and multiplexing
- Adjustable sensitivity
- Three operation modes: Distance to Object (DtO), Window (Wnd) or Object between sensor and background (ObSB)

Your benefits

- Easy machine integration due to compact size
- Various setup options ensure flexible adaptation to applications
- Multiplex mode eliminates crosstalk interference for consistent and reliable detection and high measurement reliability
- Synchronization mode allows multiple sensors to work as one large sensor, providing a low-cost solution for area detection
- Display enables setup prior to installation, reducing on-site installation time
- Integrated temperature compensation and time-of-flight technology ensure high measurement accuracy
- ObSB-mode enables detection of any object between the sensor and a taught background

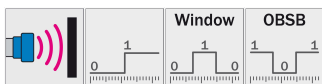

Performance

Resolution:	≤ 0.18 mm
Working range, limiting range:	600 mm ... 6,000 mm, 8,000 mm
Repeatability ¹⁾ :	± 0.15 %
Accuracy ^{2), 3)} :	± 1 %
Response time:	240 ms
Switching frequency:	2 Hz
Ultrasonic frequency (typical):	80 kHz
Detection area (typical):	See diagrams
Temperature compensation:	✓

Additional function:	Set switching mode: Distance to object (DtO)/switching window (Wnd)/ Object Between Sensor and Background (ObSB) Teach-in of switching output Set levels of switching outputs Set on delay switching output Temperature compensation Synchronization of up to 10 sensors Multiplexing: no cross talk of up to 10 sensors Set measurement filters: value filter, filter strength, adjustable sensitivity, foreground suppression and detection area Reset to factory default Switch-off display Switching output invertible Functions may vary depending on sensor type
Output time:	60 ms

^{1) 2)} Referring to current measurement value ³⁾ Temperature compensation can be switched off, without temperature compensation: 0.17 %/K

Interfaces

Output type ^{1), 2)} :	2 x PNP (200 mA)
Hysteresis:	100 mm
Multifunctional input (MF):	1 x MF

¹⁾ Output Q short-circuit protected ²⁾ PNP: HIGH = V_S - (< 2 V)/LOW = 0 V

Mechanics/electronics

Sending axis:	Straight
Supply voltage V_S ^{1), 2)} :	DC 9 V ... 30 V
Power consumption ³⁾ :	≤ 2.4 W
Initialization time:	< 300 ms
Design:	Cylindrical
Housing material:	Nickel-plated brass, PBT display: TPU ultrasonic transducer: polyurethane foam, glass epoxy resin
Electrical connection:	Male connector, M12, 5-pin
Indication:	LED display, 2 x LED
Weight:	270 g

¹⁾ Limit values, reverse-polarity protected, operation in short-circuit protected network: max. 8 A ²⁾ 15 V ... 30 V when using analog voltage output ³⁾ Without load

Ambient data

Enclosure rating:	IP 67
Protection class:	III
Ambient temperature:	Operation: -25 ... +70 °C Storage: -40 ... +85 °C

Dimensional drawing

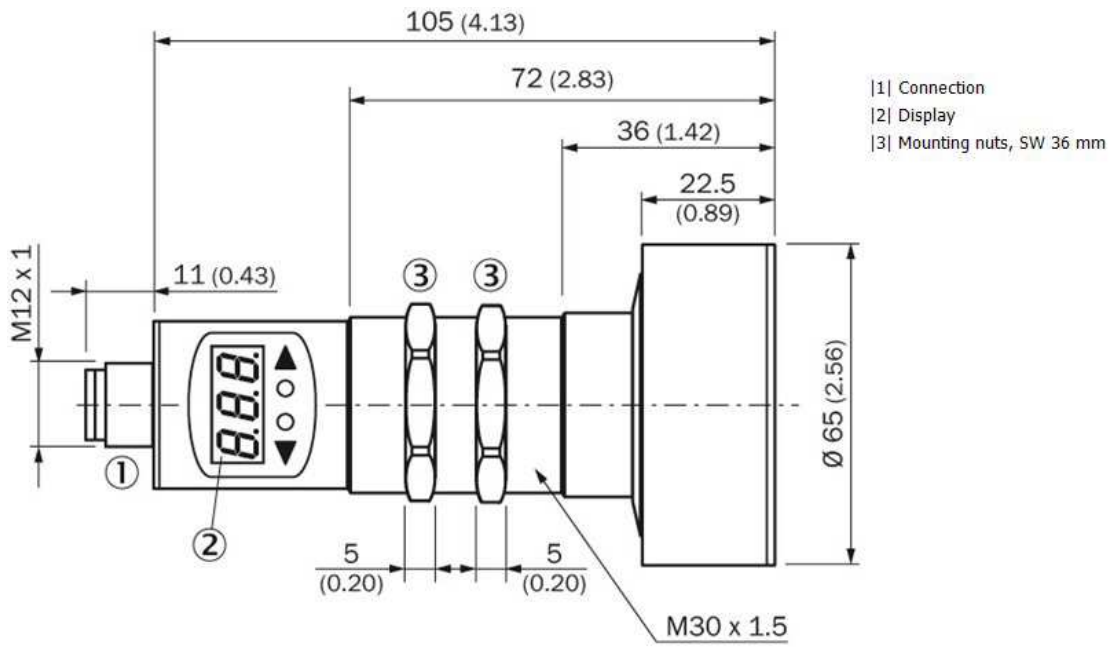

Adjustments

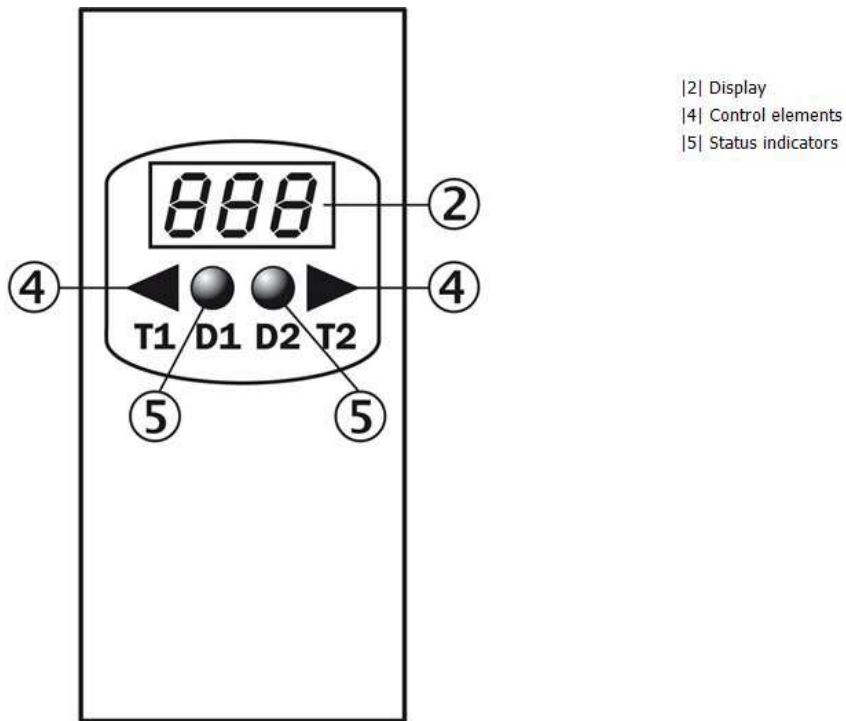

Connection diagram

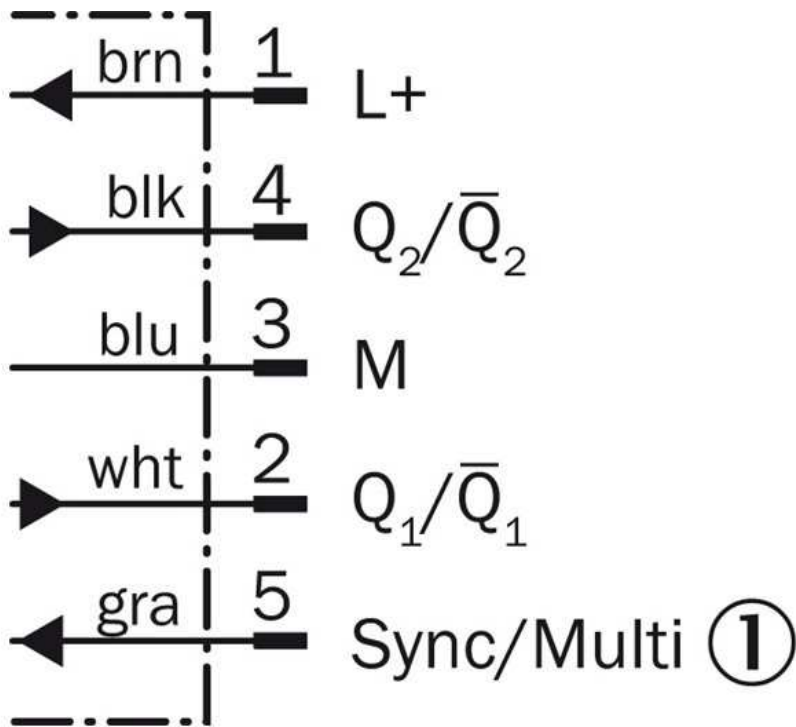

[1] Synchronization and multiplex operation/communication Connect+

Detection area

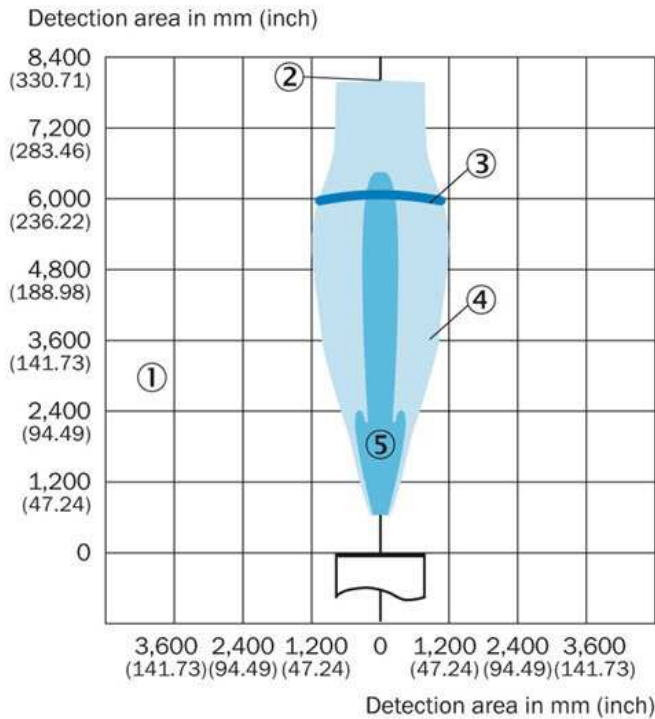

- [1] Sensing range dependent on reflection properties, size and orientation of the object
- [2] Limiting range
- [3] Working range
- [4] example object: aligned plate 500 mm x 500 mm
- [5] example object: pipe with 27 mm diameter

Connection type

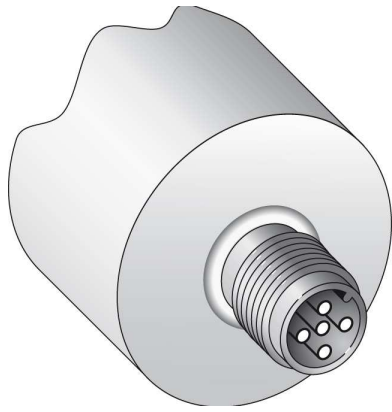

Australia

Phone +61 3 9457 0600
1800 33 48 02 – tollfree
E-Mail sales@sick.com.au

Belgium/Luxembourg

Phone +32 (0)2 466 55 66
E-Mail info@sick.be

Brasil

Phone +55 11 3215-4900
E-Mail marketing@sick.com.br

Canada

Phone +1 905 771 14 44
E-Mail information@sick.com

Česká republika

Phone +420 2 57 91 18 50
E-Mail sick@sick.cz

China

Phone +86 4000 121 000
E-Mail info.china@sick.net.cn
Phone +852-2153 6300
E-Mail ghk@sick.com.hk

Danmark

Phone +45 45 82 64 00
E-Mail sick@sick.dk

Deutschland

Phone +49 211 5301-301
E-Mail info@sick.de

España

Phone +34 93 480 31 00
E-Mail info@sick.es

France

Phone +33 1 64 62 35 00
E-Mail info@sick.fr

Great Britain

Phone +44 (0)1727 831121
E-Mail info@sick.co.uk

India

Phone +91-22-4033 8333
E-Mail info@sick-india.com

Israel

Phone +972-4-6881000
E-Mail info@sick-sensors.com

Italia

Phone +39 02 27 43 41
E-Mail info@sick.it

Japan

Phone +81 (0)3 5309 2112
E-Mail support@sick.jp

Magyarország

Phone +36 1 371 2680
E-Mail office@sick.hu

Nederland

Phone +31 (0)30 229 25 44
E-Mail info@sick.nl

Norge

Phone +47 67 81 50 00
E-Mail sick@sick.no

Österreich

Phone +43 (0)22 36 62 28 8-0
E-Mail office@sick.at

Polska

Phone +48 22 837 40 50
E-Mail info@sick.pl

România

Phone +40 356 171 120
E-Mail office@sick.ro

Russia

Phone +7-495-775-05-30
E-Mail info@sick.ru

Schweiz

Phone +41 41 619 29 39
E-Mail contact@sick.ch

Singapore

Phone +65 6744 3732
E-Mail sales.gsg@sick.com

Slovenija

Phone +386 (0)1-47 69 990
E-Mail office@sick.si

South Africa

Phone +27 11 472 3733
E-Mail info@sickautomation.co.za

South Korea

Phone +82 2 786 6321/4
E-Mail info@sickkorea.net

Suomi

Phone +358-9-25 15 800
E-Mail sick@sick.fi

Sverige

Phone +46 10 110 10 00
E-Mail info@sick.se

Taiwan

Phone +886 2 2375-6288
E-Mail sales@sick.com.tw

Türkiye

Phone +90 (216) 528 50 00
E-Mail info@sick.com.tr

United Arab Emirates

Phone +971 (0) 4 88 65 878
E-Mail info@sick.ae

USA/México

Phone +1(952) 941-6780
1 (800) 325-7425 – tollfree
E-Mail info@sickusa.com

More representatives and agencies
at www.sick.com