



Pressure sensors
Pressure transmitter

PHT-RBX60ST10S0AMS0Z



Model Name > [PHT-RBX60ST10S0AMS0Z](#)
Part No. > [6039292](#)



Illustration may differ

At a glance

- Robust and precise pressure measurement technology
- Gauge measuring ranges from 0 ... 0.25 bar up to 0 ... 25 bar
- Available in 2 accuracy classes:
- Flush-mounted, hermetically sealed stainless steel membrane with roughness Ra < 0.4 µm
- Wetted parts stainless steel 1.4435, housing stainless steel 1.4571
- Large range of hygienic process connectors
- Stainless steel housing and field housing with enclosure rating of up to IP 68

Your benefits

- Perfectly suited for demanding hygienic applications in the food and beverage, pharmaceutical and cosmetics industries
- Safe hygienic operation through EHEDG and 3-A certifications
- High reliability due to robust design and use of high-grade materials
- Withstands CIP/SIP, ensuring high system availability and reliability
- Transmitter housing is easily cleaned
- Versatile configurability optimizes solutions



Features

Pressure type:	Gauge pressure
Measuring range:	0 bar ... 0.6 bar
Process temperature:	-20 °C ... 150 °C
Rated temperature:	0 °C ... 80 °C
CE-conformity:	✓
Output signal:	4...20 mA

Performance

Accuracy:	≤ +/- 0.5 % (of span)
Non-linearity:	0.2 % (Best Fit Straight Line (BFSL))
Response time:	≤ 10 ms

Mechanics/electronics

Process connection:	Tri-Clamp DN 1 ½"
Wetted parts:	Stainless steel 1.4435
Housing material:	Stainless steel 1.4571
Enclosure rating:	IP 67

Electrical connection:	M12 x 1, 4-pin
Supply voltage:	10 V DC ... 30 V DC
Electrical safety:	Short-circuit protection: QA towards M, Overvoltage protection: 36 V DC, Reverse polarity protection: L+ towards M
Dielectric strength:	500 V DC, NEC Class 02 power supply (low voltage and low current max. 100 VA even under fault conditions)
Protection class III:	✓
Weight sensor:	± 500 g

Ambient data

Ambient temperature:	-20 °C ... 80 °C
Shock load:	500 g according to IEC 60068-2-27 (mechanical shock)
Vibration load:	15g per IEC 60068-2-6 (vibration under resonance)

Dimensional drawing housing

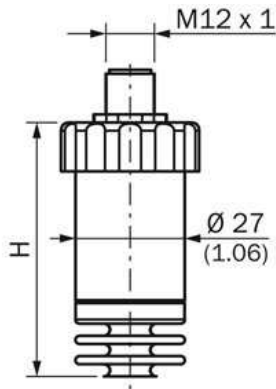

With accuracy H

0.5 %	64 (2.52)
0.25 %	84 (3.31)

Dimensional drawing process connection

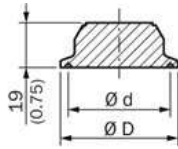

Design		Ø D	Ø d
Tri-Clamp	1 1/2"	50 (1.97)	43.5 (1.71)
	2"	64 (2.52)	56.6 (2.23)
DIN 32676	DN 32	50 (1.97)	43.5 (1.71)
	DN 40	50 (1.97)	43.5 (1.71)
	DN 50	64 (2.52)	56.6 (2.23)
ISO 2852	DN 33.7	50 (1.97)	43.5 (1.71)
	DN 38	50 (1.97)	43.5 (1.71)
	DN 40	64 (2.52)	56.6 (2.23)
	DN 51	64 (2.52)	56.6 (2.23)

Connection type

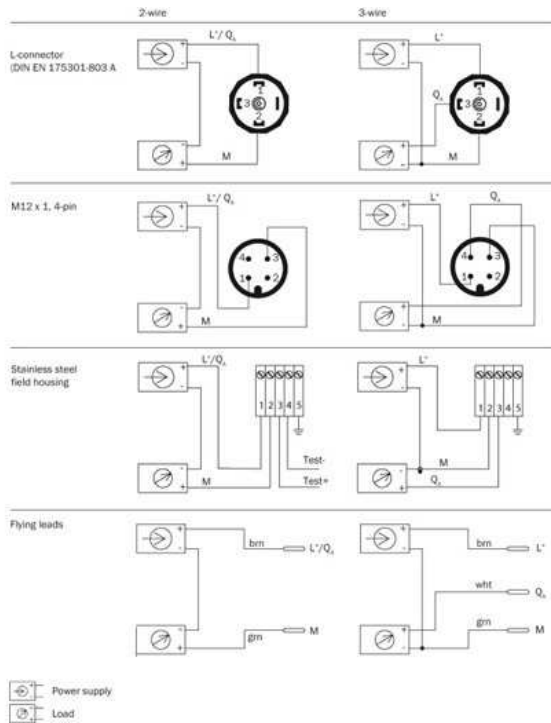

Australia

Phone +61 3 9457 0600
1800 33 48 02 – tollfree
E-Mail sales@sick.com.au

Belgium/Luxembourg

Phone +32 (0)2 466 55 66
E-Mail info@sick.be

Brasil

Phone +55 11 3215-4900
E-Mail marketing@sick.com.br

Canada

Phone +1 905 771 14 44
E-Mail information@sick.com

Česká republika

Phone +420 2 57 91 18 50
E-Mail sick@sick.cz

China

Phone +86 4000 121 000
E-Mail info.china@sick.net.cn
Phone +852-2153 6300
E-Mail ghk@sick.com.hk

Danmark

Phone +45 45 82 64 00
E-Mail sick@sick.dk

Deutschland

Phone +49 211 5301-301
E-Mail info@sick.de

España

Phone +34 93 480 31 00
E-Mail info@sick.es

France

Phone +33 1 64 62 35 00
E-Mail info@sick.fr

Great Britain

Phone +44 (0)1727 831121
E-Mail info@sick.co.uk

India

Phone +91-22-4033 8333
E-Mail info@sick-india.com

Israel

Phone +972-4-6881000
E-Mail info@sick-sensors.com

Italia

Phone +39 02 27 43 41
E-Mail info@sick.it

Japan

Phone +81 (0)3 5309 2112
E-Mail support@sick.jp

Magyarország

Phone +36 1 371 2680
E-Mail office@sick.hu

Nederland

Phone +31 (0)30 229 25 44
E-Mail info@sick.nl

Norge

Phone +47 67 81 50 00
E-Mail sick@sick.no

Österreich

Phone +43 (0)22 36 62 28 8-0
E-Mail office@sick.at

Polska

Phone +48 22 837 40 50
E-Mail info@sick.pl

România

Phone +40 356 171 120
E-Mail office@sick.ro

Russia

Phone +7-495-775-05-30
E-Mail info@sick.ru

Schweiz

Phone +41 41 619 29 39
E-Mail contact@sick.ch

Singapore

Phone +65 6744 3732
E-Mail sales.gsg@sick.com

Slovenija

Phone +386 (0)1-47 69 990
E-Mail office@sick.si

South Africa

Phone +27 11 472 3733
E-Mail info@sickautomation.co.za

South Korea

Phone +82 2 786 6321/4
E-Mail info@sickkorea.net

Suomi

Phone +358-9-25 15 800
E-Mail sick@sick.fi

Sverige

Phone +46 10 110 10 00
E-Mail info@sick.se

Taiwan

Phone +886 2 2375-6288
E-Mail sales@sick.com.tw

Türkiye

Phone +90 (216) 528 50 00
E-Mail info@sick.com.tr

United Arab Emirates

Phone +971 (0) 4 88 65 878
E-Mail info@sick.ae

USA/México

Phone +1(952) 941-6780
1 (800) 325-7425 – tollfree
E-Mail info@sickusa.com

More representatives and agencies
at www.sick.com