



Pressure sensors  
Pressure transmitter

PHT-RBX60SD40S0AMS0Z



**Model Name** > [PHT-RBX60SD40S0AMS0Z](#)  
**Part No.** > [6039306](#)



*Illustration may differ*

**At a glance**

- Robust and precise pressure measurement technology
- Gauge measuring ranges from 0 ... 0.25 bar up to 0 ... 25 bar
- Available in 2 accuracy classes:
- Flush-mounted, hermetically sealed stainless steel membrane with roughness Ra < 0.4 µm
- Wetted parts stainless steel 1.4435, housing stainless steel 1.4571
- Large range of hygienic process connectors
- Stainless steel housing and field housing with enclosure rating of up to IP 68

**Your benefits**

- Perfectly suited for demanding hygienic applications in the food and beverage, pharmaceutical and cosmetics industries
- Safe hygienic operation through EHEDG and 3-A certifications
- High reliability due to robust design and use of high-grade materials
- Withstands CIP/SIP, ensuring high system availability and reliability
- Transmitter housing is easily cleaned
- Versatile configurability optimizes solutions



**Features**

Pressure type:	Gauge pressure
Measuring range:	0 bar ... 0.6 bar
Process temperature:	-20 °C ... 150 °C
Rated temperature:	0 °C ... 80 °C
CE-conformity:	✓
Output signal:	4...20 mA

**Performance**

Accuracy:	≤ +/- 0.5 % (of span)
Non-linearity:	0.2 % (Best Fit Straight Line (BFSL))
Response time:	≤ 10 ms

**Mechanics/electronics**

Process connection:	Clamp DIN 32676 DN 40
Wetted parts:	Stainless steel 1.4435
Housing material:	Stainless steel 1.4571
Enclosure rating:	IP 67

Electrical connection:	M12 x 1, 4-pin
Supply voltage:	10 V DC ... 30 V DC
Electrical safety:	Short-circuit protection: QA towards M, Overvoltage protection: 36 V DC, Reverse polarity protection: L+ towards M
Dielectric strength:	500 V DC, NEC Class 02 power supply (low voltage and low current max. 100 VA even under fault conditions)
Protection class III:	✓
Weight sensor:	± 500 g

#### Ambient data

Ambient temperature:	-20 °C ... 80 °C
Shock load:	500 g according to IEC 60068-2-27 (mechanical shock)
Vibration load:	15g per IEC 60068-2-6 (vibration under resonance)

#### Dimensional drawing housing

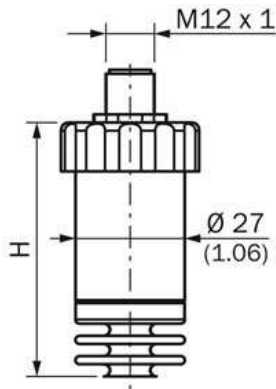

#### With accuracy H

<b>0.5 %</b>	64 (2.52)
<b>0.25 %</b>	84 (3.31)

## Dimensional drawing process connection

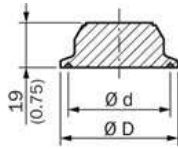

Design		Ø D	Ø d
<b>Tri-Clamp</b>	1 1/2"	50 (1.97)	43.5 (1.71)
	2"	64 (2.52)	56.6 (2.23)
<b>DIN 32676</b>	DN 32	50 (1.97)	43.5 (1.71)
	DN 40	50 (1.97)	43.5 (1.71)
	DN 50	64 (2.52)	56.6 (2.23)
<b>ISO 2852</b>	DN 33.7	50 (1.97)	43.5 (1.71)
	DN 38	50 (1.97)	43.5 (1.71)
	DN 40	64 (2.52)	56.6 (2.23)
	DN 51	64 (2.52)	56.6 (2.23)

## Connection type

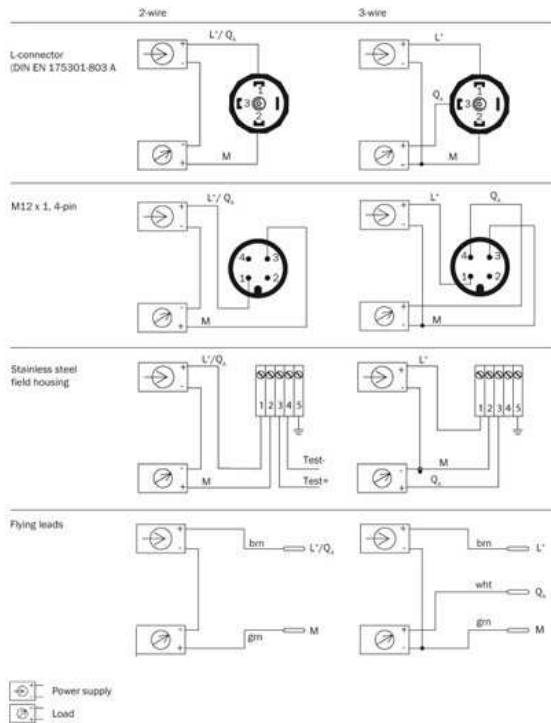

**Australia**

Phone +61 3 9457 0600  
1800 33 48 02 – tollfree  
E-Mail sales@sick.com.au

**Belgium/Luxembourg**

Phone +32 (0)2 466 55 66  
E-Mail info@sick.be

**Brasil**

Phone +55 11 3215-4900  
E-Mail marketing@sick.com.br

**Canada**

Phone +1 905 771 14 44  
E-Mail information@sick.com

**Česká republika**

Phone +420 2 57 91 18 50  
E-Mail sick@sick.cz

**China**

Phone +86 4000 121 000  
E-Mail info.china@sick.net.cn  
Phone +852-2153 6300  
E-Mail ghk@sick.com.hk

**Danmark**

Phone +45 45 82 64 00  
E-Mail sick@sick.dk

**Deutschland**

Phone +49 211 5301-301  
E-Mail info@sick.de

**España**

Phone +34 93 480 31 00  
E-Mail info@sick.es

**France**

Phone +33 1 64 62 35 00  
E-Mail info@sick.fr

**Great Britain**

Phone +44 (0)1727 831121  
E-Mail info@sick.co.uk

**India**

Phone +91-22-4033 8333  
E-Mail info@sick-india.com

**Israel**

Phone +972-4-6881000  
E-Mail info@sick-sensors.com

**Italia**

Phone +39 02 27 43 41  
E-Mail info@sick.it

**Japan**

Phone +81 (0)3 5309 2112  
E-Mail support@sick.jp

**Magyarország**

Phone +36 1 371 2680  
E-Mail office@sick.hu

**Nederland**

Phone +31 (0)30 229 25 44  
E-Mail info@sick.nl

**Norge**

Phone +47 67 81 50 00  
E-Mail sick@sick.no

**Österreich**

Phone +43 (0)22 36 62 28 8-0  
E-Mail office@sick.at

**Polska**

Phone +48 22 837 40 50  
E-Mail info@sick.pl

**România**

Phone +40 356 171 120  
E-Mail office@sick.ro

**Russia**

Phone +7-495-775-05-30  
E-Mail info@sick.ru

**Schweiz**

Phone +41 41 619 29 39  
E-Mail contact@sick.ch

**Singapore**

Phone +65 6744 3732  
E-Mail sales.gsg@sick.com

**Slovenija**

Phone +386 (0)1-47 69 990  
E-Mail office@sick.si

**South Africa**

Phone +27 11 472 3733  
E-Mail info@sickautomation.co.za

**South Korea**

Phone +82 2 786 6321/4  
E-Mail info@sickkorea.net

**Suomi**

Phone +358-9-25 15 800  
E-Mail sick@sick.fi

**Sverige**

Phone +46 10 110 10 00  
E-Mail info@sick.se

**Taiwan**

Phone +886 2 2375-6288  
E-Mail sales@sick.com.tw

**Türkiye**

Phone +90 (216) 528 50 00  
E-Mail info@sick.com.tr

**United Arab Emirates**

Phone +971 (0) 4 88 65 878  
E-Mail info@sick.ae

**USA/México**

Phone +1(952) 941-6780  
1 (800) 325-7425 – tollfree  
E-Mail info@sickusa.com

More representatives and agencies  
at [www.sick.com](http://www.sick.com)