



Pressure sensors
Pressure switch

PBS-RB060SG2SS0BMA0Z



Model Name > **PBS-RB060SG2SS0BMA0Z**
Part No. > **6042061**



Illustration may differ

At a glance

- Gauge measurement ranges from 0 ... 1 bar up to 0 ... 600 bar
- No moving parts: No mechanical wear, fatigue-proof, maintenance-free
- Stainless steel membrane
- Various programmable switching functions
- Digital outputs PNP or NPN, Analog output signal 4 ... 20 mA or 0 ... 10 V
- Min/max pressure memory
- Password protection
- Selection of different pressure units for the display
- IO-Link optional

Your benefits

- Quick and easy setup and operation due to three large pushbuttons and clear display
- Perfect display readability and optimal cable routing due to rotatable housing
- No compromises: Individual solutions through a variety of configurations
- Universal application due to fully welded, highly durable stainless steel membrane
- Saves space and costs: no adapters required due to broad range of standard process connections
- Highly reliable due to application of proven technologies and high-quality materials, water resistance according to IP 65 and IP 67 as well as excellent overpressure safety
- Ultimate system availability: IO-Link enables fast, reliable parameter setting when changing over products



Features

Pressure type:	Gauge pressure
Measuring range:	0 bar ... 60 bar
Process temperature:	-20 °C ... +85 °C
Display:	14-segment-LED, blue, 4-digits, height 9 mm, electronically turnable by 180°, Update: 1,000, 500, 200, 100 ms (adjustable), Accuracy: ≤ 1 % of span ± 1 digit
Output signal:	1 x PNP + 4 mA ... 20 mA
Rotatable housing:	Display against housing with electrical connection: 330°, Housing against process connection: 320°
Gauge pressure:	0 bar ... 1 bar up to bar ... 600 bar
Absolute pressure:	0 bar ... 1 bar up to 0 bar ... 25 bar
Compound pressure:	-1 bar ... 0 bar up to -1 bar ... +24 bar
Zero point adjustment:	Max. + 3 % of span

Medium: Liquid and gaseous media

Performance

Accuracy: $\leq \pm 1\%$ of span, (Including non-linearity, hysteresis, zero point and full scale error (corresponds to error of measurement according to IEC 61298-2))

Non-linearity: $\leq \pm 0.5\%$ (of span (Best Fit Straight Line, BFSL) according to IEC 61298-2)

Setting accuracy of switching outputs: $\leq \pm 0.5\%$ of span

Response time: 3 ms

Long-term drift/one-year stability: $\leq 0.2\%$ of span according to IEC 61298-2

Temperature coefficient in rated temperature range: Mean TC of span $\leq 0.2\%$ of span / 10 K, Mean TC of zero: $\leq 0.2\%$ of span / 10 K

Rated temperature range: 0 °C ... +80 °C

Service life: Minimum 100 Mio. life cycles

Mechanics/electronics

Process connection: G ¼ female

Wetted parts: Pressure connection: stainless steel 316L, Pressure sensor: stainless steel 316L (for measurement ranges from 0 bar ... 10 bar rel stainless steel 13-8 PH)

Seal: Without seal

Pressure port: Standard

Housing material: Display window: PC, Plastic head: PC + ABS, Buttons: TPE-E, Lower body: stainless steel 304

Enclosure rating: IP 67

Electrical connection: Round connector M12 x 1, 4-pin, IP 67

Power consumption: 45 mA (for configurations without analog output signal), 70 mA (for configurations with analog output signal)

Electrical safety: Short-circuit protection: QA, Q1, Q2 towards M, Protection class: III, Overvoltage protection: 40 V DC, Reverse polarity protection: L+ towards M

Protection class III: ✓

Weight sensor: Ca. 200 g

Internal transmission fluid: Silicone oil (only with pressure ranges < 0 bar ... 10 bar and ≤ 0 bar abs ... 25 bar abs)

Total current consumption: Max. 350 mA / 570 mA (incl. switching current)

Isolation voltage: 500 V DC

CE-conformity: Pressure equipment directive: This instrument is a pressure accessory as defined by the directive 97/23/EC, EMC directive: 2004/108/EC, EN 61326-2-3

Ambient data

Storage temperature: -20 °C ... +80 °C

Ambient temperature: -20 °C ... +80 °C

Shock load: 50 g according to IEC 60068-2-27 (mechanical shock)

Vibration load: 10 g according to IEC 60068-2-6 (vibration under resonance)

Relative humidity: $\leq 90\%$

Connection type

M12 x 1, 4-pin

2 switching outputs/
1 switching output + 1 analog output



L' = 1, M = 3, Q₁ = 4, Q₂ = 2
C/Q₁ = 4, Q_A = 2

M12 x 1, 5-pin

2 switching outputs + 1 analog output



L' = 1, M = 3, Q₁ = 4, Q₂ = 2, Q_A = 5
C/Q₁ = 4

- [1] L+: Positive supply connection
- [2] M: Negative supply connection
- [3] Q1: Switching output 1
- [4] C/Q1: With IO-Link: Communication/ switching output 1
- [5] Q2: Switching output 2
- [6] QA: Analog output

Dimensional drawing housing

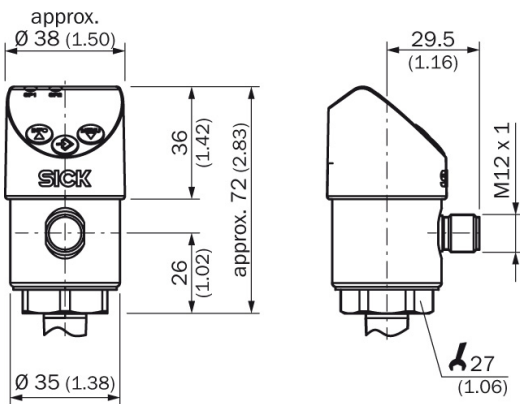

Dimensional drawing process connection

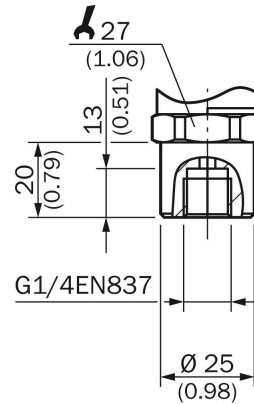

Australia

Phone +61 3 9457 0600
1800 33 48 02 – tollfree
E-Mail sales@sick.com.au

Belgium/Luxembourg

Phone +32 (0)2 466 55 66
E-Mail info@sick.be

Brasil

Phone +55 11 3215-4900
E-Mail marketing@sick.com.br

Canada

Phone +1 905 771 14 44
E-Mail information@sick.com

Česká republika

Phone +420 2 57 91 18 50
E-Mail sick@sick.cz

China

Phone +86 4000 121 000
E-Mail info.china@sick.net.cn
Phone +852-2153 6300
E-Mail ghk@sick.com.hk

Danmark

Phone +45 45 82 64 00
E-Mail sick@sick.dk

Deutschland

Phone +49 211 5301-301
E-Mail info@sick.de

España

Phone +34 93 480 31 00
E-Mail info@sick.es

France

Phone +33 1 64 62 35 00
E-Mail info@sick.fr

Great Britain

Phone +44 (0)1727 831121
E-Mail info@sick.co.uk

India

Phone +91-22-4033 8333
E-Mail info@sick-india.com

Israel

Phone +972-4-6881000
E-Mail info@sick-sensors.com

Italia

Phone +39 02 27 43 41
E-Mail info@sick.it

Japan

Phone +81 (0)3 5309 2112
E-Mail support@sick.jp

Magyarország

Phone +36 1 371 2680
E-Mail office@sick.hu

Nederland

Phone +31 (0)30 229 25 44
E-Mail info@sick.nl

Norge

Phone +47 67 81 50 00
E-Mail sick@sick.no

Österreich

Phone +43 (0)22 36 62 28 8-0
E-Mail office@sick.at

Polska

Phone +48 22 837 40 50
E-Mail info@sick.pl

România

Phone +40 356 171 120
E-Mail office@sick.ro

Russia

Phone +7-495-775-05-30
E-Mail info@sick.ru

Schweiz

Phone +41 41 619 29 39
E-Mail contact@sick.ch

Singapore

Phone +65 6744 3732
E-Mail sales.gsg@sick.com

Slovenija

Phone +386 (0)1-47 69 990
E-Mail office@sick.si

South Africa

Phone +27 11 472 3733
E-Mail info@sickautomation.co.za

South Korea

Phone +82 2 786 6321/4
E-Mail info@sickkorea.net

Suomi

Phone +358-9-25 15 800
E-Mail sick@sick.fi

Sverige

Phone +46 10 110 10 00
E-Mail info@sick.se

Taiwan

Phone +886 2 2375-6288
E-Mail sales@sick.com.tw

Türkiye

Phone +90 (216) 528 50 00
E-Mail info@sick.com.tr

United Arab Emirates

Phone +971 (0) 4 88 65 878
E-Mail info@sick.ae

USA/México

Phone +1(952) 941-6780
1 (800) 325-7425 – tollfree
E-Mail info@sickusa.com

More representatives and agencies
at www.sick.com