



Pressure sensors
Pressure transmitter

PBT-RB016SG1SENAMA0Z



Model Name > **PBT-RB016SG1SENAMA0Z**
Part No. > **6042804**



Product may differ from illustration

At a glance

- Gauge pressure measurement ranges from 0 ... 1 bar up to 0 ... 600 bar
- A large variety of available process connections
- No moving parts: No mechanical wear, fatigue-proof, maintenance-free
- Circularly welded, hermetically sealed stainless steel membrane
- Output signal 4 ... 20 mA, 0 ... 5 V or 0 ... 10 V
- Electrical connection M12x1, L-connector acc. to DIN 175301-803 A or flying leads

Your benefits

- Compact size takes up less space
- Simple and cost-saving installation
- Available in a wide selection of configurations, enabling a perfect match to individual customer requirements
- Robust design enables higher reliability
- Excellent price/performance ratio



Features

Pressure type:	Gauge pressure
Measuring range:	0 bar ... 16 bar
Process temperature:	-30 °C ... +100 °C
Output signal:	4 mA ... 20 mA
Gauge pressure:	0 bar ... 1 bar up to bar ... 600 bar
Absolute pressure:	0 bar ... 1 bar up to 0 bar ... 25 bar
Compound pressure:	-1 bar ... 0 bar up to -1 bar ... +24 bar
Medium:	Liquid and gaseous media

Performance

Accuracy:	≤ ± 0,6 % of Span (with non-linearity 0.25 % and with signal output 0 ... 5 V), ≤ ± 1 % of span (with non-linearity 0.25 %), ≤ ± 1,0 % of Span (with non-linearity 0.5 %), (Including non-linearity, hysteresis, zero point and full scale error (corresponds to error of measurement according to IEC 61298-2))
Non-linearity:	≤ ± 0.5 % ((Best Fit Straight Line, BFSL) according to IEC 61298-2)
Response time:	< 4 ms
Long-term drift/one-year stability:	≤ 0.1 % of span according to IEC 61298-2
Rated temperature range:	0 °C ... +80 °C
Service life:	Minimum 100 Mio. life cycles
Non-repeatability:	≤ 0.1 % of span

Hysteresis:	≤ 0.16 % of span
Signal noise:	≤ 0.3 % of span
Adjustment accuracy of zero signal:	≤ 0.5 % of span typ., ≤ 0.8 % of span max. (with non-linearity 0.5 %)

Mechanics/electronics

Process connection:	G ¼ A according to DIN 3852-E
Wetted parts:	Pressure connection: stainless steel 316L, Pressure sensor: stainless steel 316L (for measurement ranges from 0 bar ... 10 bar rel stainless steel 13-8 PH)
Seal:	NBR
Pressure port:	Standard
Housing material:	Stainless steel 316L
Enclosure rating:	IP 67
Electrical connection:	Round connector M12 x 1, 4-pin, IP 67
Power consumption:	Max. 8 mA for voltage output signal, Signal current (max. 25 mA) for current output
Electrical safety:	Short-circuit protection: QA towards M, Protection class: III, Overvoltage protection: 32 V DC, 36 V DC with 4 mA ... 20 mA, Reverse polarity protection: L+ towards M
Protection class III:	✓
Weight sensor:	Ca. 80 g
Internal transmission fluid:	Silicone oil (only with pressure ranges < 0 bar ... 10 bar and ≤ 0 bar abs ... 25 bar abs)
Isolation voltage:	500 V DC
CE-conformity:	Pressure equipment directive: 97/23/EC, EMC directive: 2004/108/EC, EN 61 326-2-3
Reference conditions:	Reference conditions: According to IEC 61298-1

Ambient data

Storage temperature:	-30 °C ... +100 °C
Ambient temperature:	0 °C ... +80 °C
Shock load:	500 g according to IEC 60068-2-27 (mechanical shock)
Vibration load:	10 g according to IEC 60068-2-6 (vibration under resonance), 20 g optional
Relative humidity:	45 % ... 75 %

Dimensional drawing housing

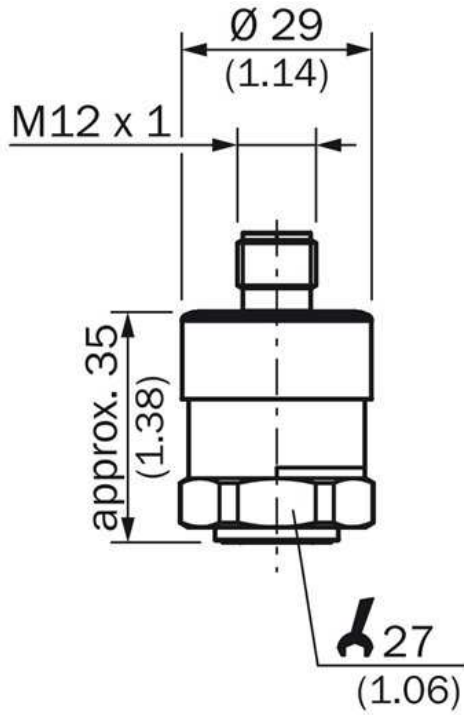

Dimensional drawing process connection

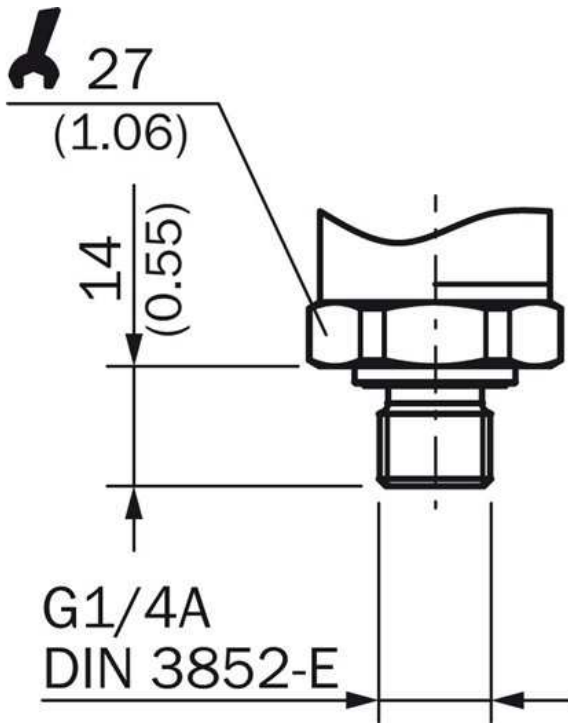

Australia

Phone +61 3 9457 0600
1800 33 48 02 – tollfree
E-Mail sales@sick.com.au

Belgium/Luxembourg

Phone +32 (0)2 466 55 66
E-Mail info@sick.be

Brasil

Phone +55 11 3215-4900
E-Mail marketing@sick.com.br

Canada

Phone +1 905 771 14 44
E-Mail information@sick.com

Česká republika

Phone +420 2 57 91 18 50
E-Mail sick@sick.cz

China

Phone +86 4000 121 000
E-Mail info.china@sick.net.cn
Phone +852-2153 6300
E-Mail ghk@sick.com.hk

Danmark

Phone +45 45 82 64 00
E-Mail sick@sick.dk

Deutschland

Phone +49 211 5301-301
E-Mail info@sick.de

España

Phone +34 93 480 31 00
E-Mail info@sick.es

France

Phone +33 1 64 62 35 00
E-Mail info@sick.fr

Great Britain

Phone +44 (0)1727 831121
E-Mail info@sick.co.uk

India

Phone +91-22-4033 8333
E-Mail info@sick-india.com

Israel

Phone +972-4-6881000
E-Mail info@sick-sensors.com

Italia

Phone +39 02 27 43 41
E-Mail info@sick.it

Japan

Phone +81 (0)3 5309 2112
E-Mail support@sick.jp

Magyarország

Phone +36 1 371 2680
E-Mail office@sick.hu

Nederland

Phone +31 (0)30 229 25 44
E-Mail info@sick.nl

Norge

Phone +47 67 81 50 00
E-Mail sick@sick.no

Österreich

Phone +43 (0)22 36 62 28 8-0
E-Mail office@sick.at

Polska

Phone +48 22 837 40 50
E-Mail info@sick.pl

România

Phone +40 356 171 120
E-Mail office@sick.ro

Russia

Phone +7-495-775-05-30
E-Mail info@sick.ru

Schweiz

Phone +41 41 619 29 39
E-Mail contact@sick.ch

Singapore

Phone +65 6744 3732
E-Mail sales.gsg@sick.com

Slovenija

Phone +386 (0)1-47 69 990
E-Mail office@sick.si

South Africa

Phone +27 11 472 3733
E-Mail info@sickautomation.co.za

South Korea

Phone +82 2 786 6321/4
E-Mail info@sickkorea.net

Suomi

Phone +358-9-25 15 800
E-Mail sick@sick.fi

Sverige

Phone +46 10 110 10 00
E-Mail info@sick.se

Taiwan

Phone +886 2 2375-6288
E-Mail sales@sick.com.tw

Türkiye

Phone +90 (216) 528 50 00
E-Mail info@sick.com.tr

United Arab Emirates

Phone +971 (0) 4 88 65 878
E-Mail info@sick.ae

USA/México

Phone +1(952) 941-6780
1 (800) 325-7425 – tollfree
E-Mail info@sickusa.com

More representatives and agencies
at www.sick.com