



Temperature sensors

TSP-1MAN40305MZ



Model Name > [TSP-1MAN40305MZ](#)
Part No. > [6042966](#)



At a glance

- Platinum element (Pt100 or Pt1000, 2-wire), accuracy class B according to IEC 60751
- Measuring range -30 °C ... +130 °C
- Various connection threads and insertion lengths
- Wetted parts made from stainless steel 1.4305
- Circular connector M12 x 1 (IP 67)

Your benefits

- Reliable operation through rugged design and high-quality materials
- Good long-term stability
- Easy installation
- Convenient system integration through very compact dimensions



Features

Measuring range:	-30 °C ... 130 °C
Sensor element:	Pt1000
Output signal:	Pt1000, 2-wire

Performance

Accuracy of sensor element:	Class B according to IEC 60751
-----------------------------	--------------------------------

Mechanics/electronics

Process connection:	Thread 1/4" NPT
Insertion length/diameter of probe:	30 mm/5 mm
Housing material:	Stainless steel 1.4305
Wetted parts:	Stainless steel 1.4305
Electrical connection/enclosure rating ¹⁾ :	Plug M12 x 1, 4-pin, IP 67
Measuring current:	0.1 mA ... 0.3 mA
Electrical safety:	Dielectric strength: 500 V AC Protection class: III
Weight:	Ca. 30 g (depending on configuration)

¹⁾ Enclosure rating IP per IEC 60529. The enclosure rating classes specified only apply while the pressure transmitter is connected with female connectors that provide the corresponding enclosure rating.

Ambient data

Ambient temperature:	-40 °C ... 100 °C
Storage and transport temperature:	-40 °C ... 85 °C
Shock resistance according to IEC 60751:	500 g
Vibration resistance according to IEC 60751:	3 g

Dimensional drawing

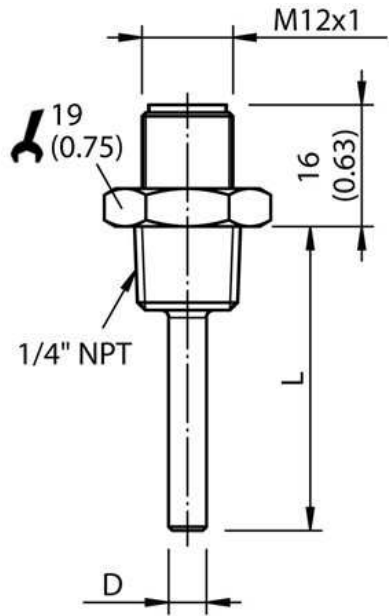

All dimensions in mm (inch)

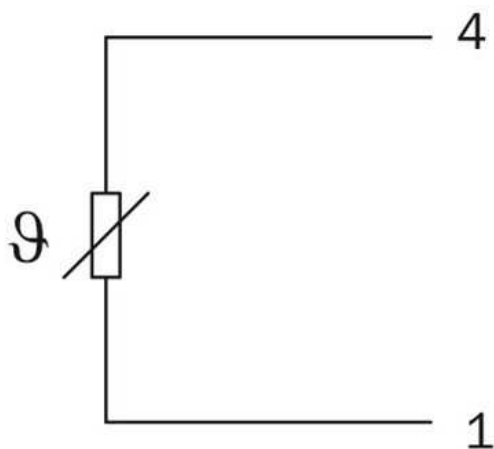
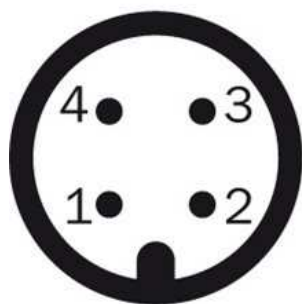

Australia

Phone +61 3 9457 0600
1800 33 48 02 – tollfree
E-Mail sales@sick.com.au

Belgium/Luxembourg

Phone +32 (0)2 466 55 66
E-Mail info@sick.be

Brasil

Phone +55 11 3215-4900
E-Mail marketing@sick.com.br

Canada

Phone +1 905 771 14 44
E-Mail information@sick.com

Česká republika

Phone +420 2 57 91 18 50
E-Mail sick@sick.cz

China

Phone +86 4000 121 000
E-Mail info.china@sick.net.cn
Phone +852-2153 6300
E-Mail ghk@sick.com.hk

Danmark

Phone +45 45 82 64 00
E-Mail sick@sick.dk

Deutschland

Phone +49 211 5301-301
E-Mail info@sick.de

España

Phone +34 93 480 31 00
E-Mail info@sick.es

France

Phone +33 1 64 62 35 00
E-Mail info@sick.fr

Great Britain

Phone +44 (0)1727 831121
E-Mail info@sick.co.uk

India

Phone +91-22-4033 8333
E-Mail info@sick-india.com

Israel

Phone +972-4-6881000
E-Mail info@sick-sensors.com

Italia

Phone +39 02 27 43 41
E-Mail info@sick.it

Japan

Phone +81 (0)3 5309 2112
E-Mail support@sick.jp

Magyarország

Phone +36 1 371 2680
E-Mail office@sick.hu

Nederland

Phone +31 (0)30 229 25 44
E-Mail info@sick.nl

Norge

Phone +47 67 81 50 00
E-Mail sick@sick.no

Österreich

Phone +43 (0)22 36 62 28 8-0
E-Mail office@sick.at

Polska

Phone +48 22 837 40 50
E-Mail info@sick.pl

România

Phone +40 356 171 120
E-Mail office@sick.ro

Russia

Phone +7-495-775-05-30
E-Mail info@sick.ru

Schweiz

Phone +41 41 619 29 39
E-Mail contact@sick.ch

Singapore

Phone +65 6744 3732
E-Mail sales.gsg@sick.com

Slovenija

Phone +386 (0)1-47 69 990
E-Mail office@sick.si

South Africa

Phone +27 11 472 3733
E-Mail info@sickautomation.co.za

South Korea

Phone +82 2 786 6321/4
E-Mail info@sickkorea.net

Suomi

Phone +358-9-25 15 800
E-Mail sick@sick.fi

Sverige

Phone +46 10 110 10 00
E-Mail info@sick.se

Taiwan

Phone +886 2 2375-6288
E-Mail sales@sick.com.tw

Türkiye

Phone +90 (216) 528 50 00
E-Mail info@sick.com.tr

United Arab Emirates

Phone +971 (0) 4 88 65 878
E-Mail info@sick.ae

USA/México

Phone +1(952) 941-6780
1 (800) 325-7425 – tollfree
E-Mail info@sickusa.com

More representatives and agencies
at www.sick.com