



## Temperature sensors

TBT-1AAN40253PZ



**Model Name** > [TBT-1AAN40253PZ](#)  
**Part No.** > [6043109](#)



### At a glance

- Pt100 element, accuracy class A according to IEC 60751
- Measuring ranges -50 °C ... 150 °C and -50 °C ... 250 °C
- Wetted parts made from corrosion resistant stainless steel 1.4571
- Various mechanical adaptations and insertion lengths
- Integrated transmitter with output signal 4 mA ... 20 mA (2-wire)
- Measurement accuracy of transmitter
- Cable gland M16x1.5

### Your benefits

- Reliable operation through rugged design and high-quality materials
- Good long-term stability, accuracy and linearity
- Quick and safe installation
- Convenient system integration even in narrow installation spaces
- Optimal solutions for individual requirements



### Features

Measuring range:	-50 °C ... 150 °C
Sensor element:	Pt100
Signal output and maximum ohmic load RA:	4 mA ... 20 mA, 2-wire (RA ≤ (L+ - 10 V)/0.028 A [Ohm])

### Performance

Accuracy of sensor element:	Class A according to IEC 60751
Transmitter accuracy:	≤ ± 0.1 % of span
Transmitter linearity:	≤ 0.1 % of span

### Mechanics/electronics

Process connection:	Thread 1/4" NPT
Insertion length/diameter of probe:	25 mm/3 mm
Housing material:	Stainless steel 1.4571
Wetted parts:	Stainless steel 1.4571
Electrical connection/enclosure rating <sup>1)</sup> :	Cable gland M16 x 1.5, IP 67
Measuring current:	0.3 mA ... 1 mA
Electrical safety:	Protection class: III, dielectric strength: 100 V, reverse polarity protection of variant with transmitter 4 mA ... 20 mA: L+ towards M
Weight:	Ca. 155 g (depending on configuration)
Supply voltage:	10 V DC ... 35 V DC for variant with transmitter 4 mA ... 20 mA

Protection class III: ✓  
CE-conformity: 2004/108/EC, EN 61326-2-3  
Pressure resistance: Max. 120 bar

1) Enclosure rating IP per IEC 60529. The enclosure rating classes specified only apply while the pressure transmitter is connected with female connectors that provide the corresponding enclosure rating.

### Ambient data

Ambient temperature: -40 °C ... 85 °C  
Storage and transport temperature: -40 °C ... 60 °C  
Shock resistance according to IEC 60751: 500 g  
Vibration resistance according to IEC 60751: 3 g

### Dimensional drawing housing

With cable gland IP 65

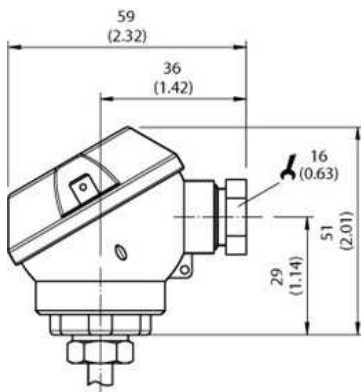

With cable gland IP 67

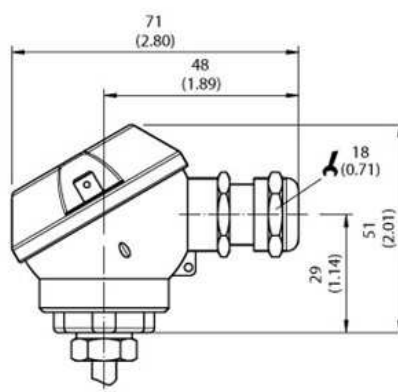

All dimensions in mm (inch)

## Dimensional drawing process connection



## Connection type

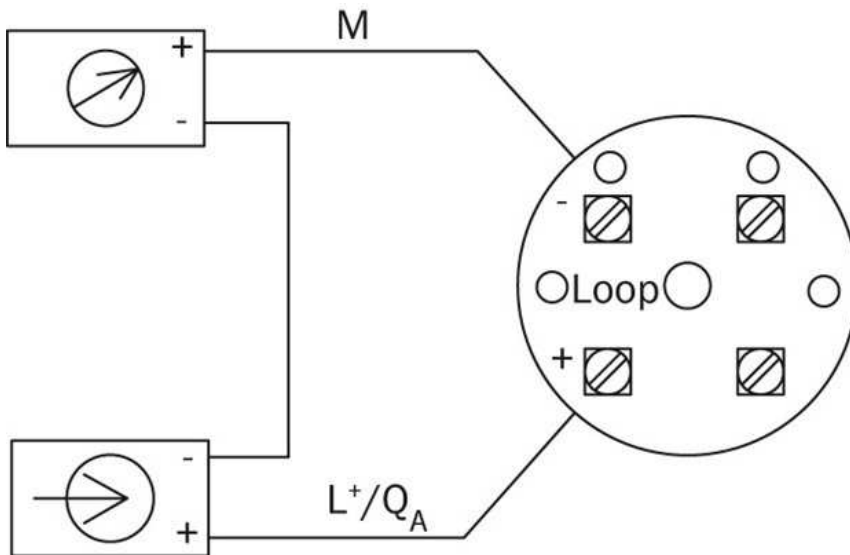

**Australia**

Phone +61 3 9457 0600  
1800 33 48 02 – tollfree  
E-Mail sales@sick.com.au

**Belgium/Luxembourg**

Phone +32 (0)2 466 55 66  
E-Mail info@sick.be

**Brasil**

Phone +55 11 3215-4900  
E-Mail marketing@sick.com.br

**Canada**

Phone +1 905 771 14 44  
E-Mail information@sick.com

**Česká republika**

Phone +420 2 57 91 18 50  
E-Mail sick@sick.cz

**China**

Phone +86 4000 121 000  
E-Mail info.china@sick.net.cn  
Phone +852-2153 6300  
E-Mail ghk@sick.com.hk

**Danmark**

Phone +45 45 82 64 00  
E-Mail sick@sick.dk

**Deutschland**

Phone +49 211 5301-301  
E-Mail info@sick.de

**España**

Phone +34 93 480 31 00  
E-Mail info@sick.es

**France**

Phone +33 1 64 62 35 00  
E-Mail info@sick.fr

**Great Britain**

Phone +44 (0)1727 831121  
E-Mail info@sick.co.uk

**India**

Phone +91-22-4033 8333  
E-Mail info@sick-india.com

**Israel**

Phone +972-4-6881000  
E-Mail info@sick-sensors.com

**Italia**

Phone +39 02 27 43 41  
E-Mail info@sick.it

**Japan**

Phone +81 (0)3 5309 2112  
E-Mail support@sick.jp

**Magyarország**

Phone +36 1 371 2680  
E-Mail office@sick.hu

**Nederland**

Phone +31 (0)30 229 25 44  
E-Mail info@sick.nl

**Norge**

Phone +47 67 81 50 00  
E-Mail sick@sick.no

**Österreich**

Phone +43 (0)22 36 62 28 8-0  
E-Mail office@sick.at

**Polska**

Phone +48 22 837 40 50  
E-Mail info@sick.pl

**România**

Phone +40 356 171 120  
E-Mail office@sick.ro

**Russia**

Phone +7-495-775-05-30  
E-Mail info@sick.ru

**Schweiz**

Phone +41 41 619 29 39  
E-Mail contact@sick.ch

**Singapore**

Phone +65 6744 3732  
E-Mail sales.gsg@sick.com

**Slovenija**

Phone +386 (0)1-47 69 990  
E-Mail office@sick.si

**South Africa**

Phone +27 11 472 3733  
E-Mail info@sickautomation.co.za

**South Korea**

Phone +82 2 786 6321/4  
E-Mail info@sickkorea.net

**Suomi**

Phone +358-9-25 15 800  
E-Mail sick@sick.fi

**Sverige**

Phone +46 10 110 10 00  
E-Mail info@sick.se

**Taiwan**

Phone +886 2 2375-6288  
E-Mail sales@sick.com.tw

**Türkiye**

Phone +90 (216) 528 50 00  
E-Mail info@sick.com.tr

**United Arab Emirates**

Phone +971 (0) 4 88 65 878  
E-Mail info@sick.ae

**USA/México**

Phone +1(952) 941-6780  
1 (800) 325-7425 – tollfree  
E-Mail info@sickusa.com

More representatives and agencies  
at [www.sick.com](http://www.sick.com)