



## Temperature sensors

TCT-1PAZZ0253MZ



**Model Name** > [TCT-1PAZZ0253MZ](#)  
**Part No.** > [6043158](#)



### At a glance

- Pt100 element, accuracy class A according to IEC 60751
- Measuring ranges -50 °C ... 150 °C and -50 °C ... 250 °C
- Wetted parts made from corrosion resistant stainless steel 316L
- Output signal Pt100 (4-wire)
- Various mechanical adaptations and insertion lengths, also available with thermowell
- Circular connector M12x1 (IP 67) or L-connector according to DIN EN 175301-803 A (IP 65)

### Your benefits

- Reliable operation through rugged design and high-quality materials
- Good long-term stability, accuracy and linearity
- Quick and safe installation
- Convenient system integration through compact dimensions and industry-standard output signals
- Optimal solutions for individual requirements



### Features

Measuring range:	-50 °C ... 150 °C
Sensor element:	Pt100
Output signal:	Pt100, 4-wire

### Performance

Accuracy of sensor element:	Class A according to IEC 60751
-----------------------------	--------------------------------

### Mechanics/electronics

Process connection:	Without process connection
Insertion length/diameter of probe:	25 mm/3 mm
Housing material:	Stainless steel 1.4571
Wetted parts:	Stainless steel 1.4571
Electrical connection/enclosure rating <sup>1)</sup> :	Plug M12 x 1, 4-pin, IP 67
Measuring current:	0.3 mA ... 1 mA
Electrical safety:	Protection class: III, dielectric strength: 500 V
Weight:	Ca. 145 g (depending on configuration)
Supply voltage:	10 V DC ... 36 V DC for variant with transmitter 4 mA ... 20 mA
Protection class III:	✓
CE-conformity:	2004/108/EC, EN 61326-2-3

1) Enclosure rating IP per IEC 60529. The enclosure rating classes specified only apply while the pressure transmitter is connected with female connectors that provide the corresponding enclosure rating.

### Ambient data

Ambient temperature:	-40 °C ... 125 °C
Storage and transport temperature:	-40 °C ... 85 °C
Shock resistance according to IEC 60751:	500 g
Vibration resistance according to IEC 60751:	3 g

### Dimensional drawing housing

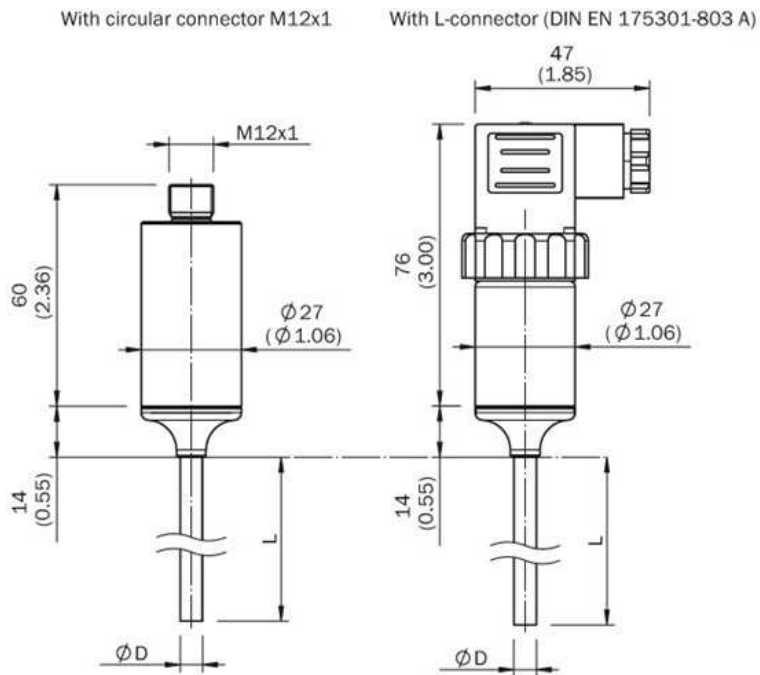

All dimensions in mm (inch)

## Dimensional drawing process connection

Mit Rundsteckverbinder M12x1

Mit Winkelstecker (DIN EN 175301-803 A)

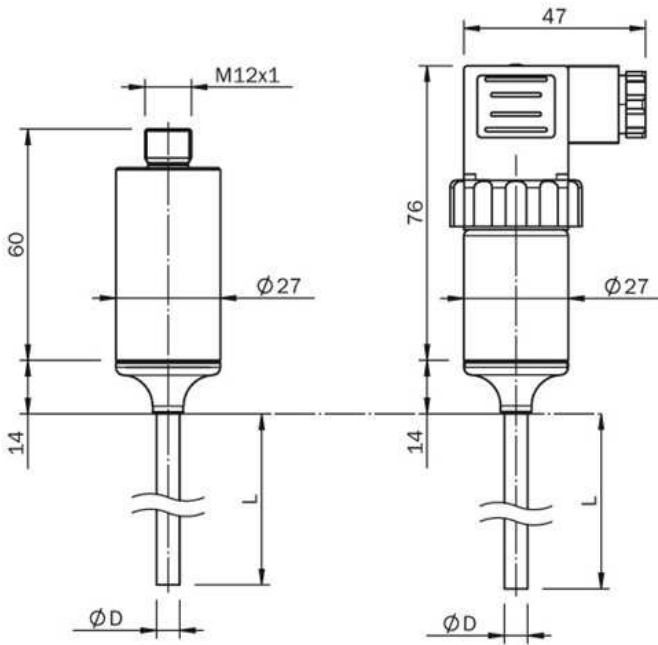

Alle Maße in mm

## Connection type

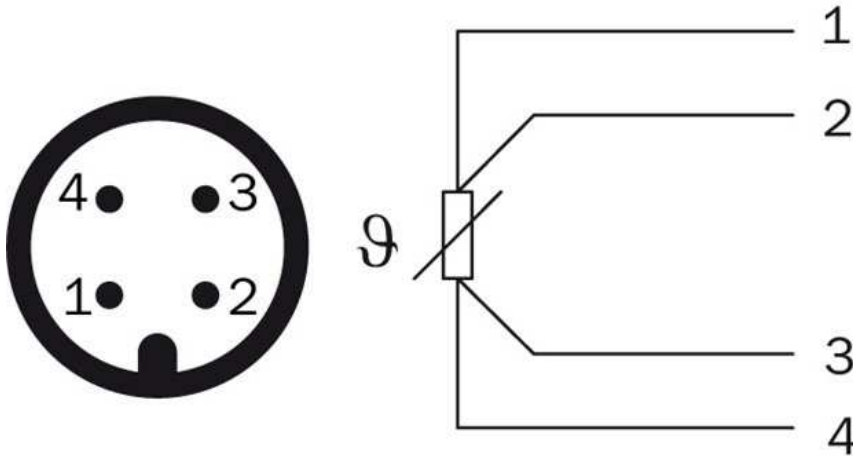

**Australia**

Phone +61 3 9457 0600  
1800 33 48 02 – tollfree  
E-Mail sales@sick.com.au

**Belgium/Luxembourg**

Phone +32 (0)2 466 55 66  
E-Mail info@sick.be

**Brasil**

Phone +55 11 3215-4900  
E-Mail marketing@sick.com.br

**Canada**

Phone +1 905 771 14 44  
E-Mail information@sick.com

**Česká republika**

Phone +420 2 57 91 18 50  
E-Mail sick@sick.cz

**China**

Phone +86 4000 121 000  
E-Mail info.china@sick.net.cn  
Phone +852-2153 6300  
E-Mail ghk@sick.com.hk

**Danmark**

Phone +45 45 82 64 00  
E-Mail sick@sick.dk

**Deutschland**

Phone +49 211 5301-301  
E-Mail info@sick.de

**España**

Phone +34 93 480 31 00  
E-Mail info@sick.es

**France**

Phone +33 1 64 62 35 00  
E-Mail info@sick.fr

**Great Britain**

Phone +44 (0)1727 831121  
E-Mail info@sick.co.uk

**India**

Phone +91-22-4033 8333  
E-Mail info@sick-india.com

**Israel**

Phone +972-4-6881000  
E-Mail info@sick-sensors.com

**Italia**

Phone +39 02 27 43 41  
E-Mail info@sick.it

**Japan**

Phone +81 (0)3 5309 2112  
E-Mail support@sick.jp

**Magyarország**

Phone +36 1 371 2680  
E-Mail office@sick.hu

**Nederland**

Phone +31 (0)30 229 25 44  
E-Mail info@sick.nl

**Norge**

Phone +47 67 81 50 00  
E-Mail sick@sick.no

**Österreich**

Phone +43 (0)22 36 62 28 8-0  
E-Mail office@sick.at

**Polska**

Phone +48 22 837 40 50  
E-Mail info@sick.pl

**România**

Phone +40 356 171 120  
E-Mail office@sick.ro

**Russia**

Phone +7-495-775-05-30  
E-Mail info@sick.ru

**Schweiz**

Phone +41 41 619 29 39  
E-Mail contact@sick.ch

**Singapore**

Phone +65 6744 3732  
E-Mail sales.gsg@sick.com

**Slovenija**

Phone +386 (0)1-47 69 990  
E-Mail office@sick.si

**South Africa**

Phone +27 11 472 3733  
E-Mail info@sickautomation.co.za

**South Korea**

Phone +82 2 786 6321/4  
E-Mail info@sickkorea.net

**Suomi**

Phone +358-9-25 15 800  
E-Mail sick@sick.fi

**Sverige**

Phone +46 10 110 10 00  
E-Mail info@sick.se

**Taiwan**

Phone +886 2 2375-6288  
E-Mail sales@sick.com.tw

**Türkiye**

Phone +90 (216) 528 50 00  
E-Mail info@sick.com.tr

**United Arab Emirates**

Phone +971 (0) 4 88 65 878  
E-Mail info@sick.ae

**USA/México**

Phone +1(952) 941-6780  
1 (800) 325-7425 – tollfree  
E-Mail info@sickusa.com

More representatives and agencies  
at [www.sick.com](http://www.sick.com)