



Pressure sensors
Pressure transmitter

PFT-SRB250SG1SSAVLSSZ



Model Name > **PFT-SRB250SG1SSAVLSSZ**
Part No. > **6043560**



Product may differ from illustration

At a glance

- Gauge pressure measurement ranges from 0 ... 0.1 bar up to 0 ... 600 bar
- Process temperature up to 125 °C (optional)
- High shock and vibration resistance
- Accuracy 0.5% or 0.25%
- Output signal 4 ... 20 mA, 0 ... 5 V, or 0 ... 10 V
- Zero and span adjustable
- Electrical connection M12x1, L-connector according to DIN 175301-803 A or flying leads

Your benefits

- Reliable and highly accurate measurement technology
- Wide application range
- No mechanical wear, fatigue-proof, maintenance-free as no moving parts
- Simple and cost-saving installation
- Optimal solution for individual requirements due to very versatile configurability
- Maximum installation flexibility due to availability of a large range of customary thread types



Features

Pressure type:	Gauge pressure
Measuring range:	0 bar ... 250 bar
Process temperature:	-30 °C ... 100 °C
CE-conformity:	✓
Output signal:	0...10 V, 3-wire

Performance

Accuracy:	≤ +/- 0.5 % (of span)
Non-linearity:	≤ +/- 0.2 % (of span (Best Fit Straight Line, BFSL) according to IEC 61298-2)
Long-term drift/one-year stability:	≤ +/- 0.2 % of span (at reference conditions)
Temperature coefficient in rated temperature range:	Mean TC of span ≤ 0.2 % of span/10 K, Mean TC of zero: ≤ 0.2 % of span/10 K (< 0.4 % for pressure ranges ≤ 0.25 bar)
Rated temperature range:	0 °C ... 80 °C
Non-repeatability:	≤ +/- 0.1 % of span
Response time (10 % ... 90 %):	≤ 1 ms (≤ 10 ms at medium temperatures below < -30°C for pressure ranges up to 25 bar or with flush-mounted membrane)

Mechanics/electronics

Process connection:	G 1/4 A according to DIN 3852-E
Wetted parts:	Standard: Stainless steel
Seal:	Without seal
Pressure port:	Standard
Housing material:	Stainless steel
Enclosure rating:	IP 65
Electrical connection:	L-connector (DIN EN 175301-803 A), IP 65
Supply voltage:	10 V DC ... 30 V DC
Electrical safety:	Short-circuit protection: QA towards M, Protection class: III, Overvoltage protection: 36 V DC, Reverse polarity protection: L+ towards M
Dielectric strength:	500 V DC, NEC Class 02 power supply (low voltage and low current max. 100 VA even under fault conditions)
Protection class III:	✓
Weight sensor:	200 g
CE-conformity:	Pressure equipment directive: 97/23/EC, EMC directive: 2004/108/EC, EN 61 326-2-3

Ambient data

Storage temperature:	-40 °C ... 100 °C
Ambient temperature:	-20 °C ... 80 °C
Shock load:	1000 g according to IEC 60068-2-27 (mechanical shock)
Vibration load:	20 g according to IEC 60068-2-6 (vibration under resonance)

Dimensional drawing housing

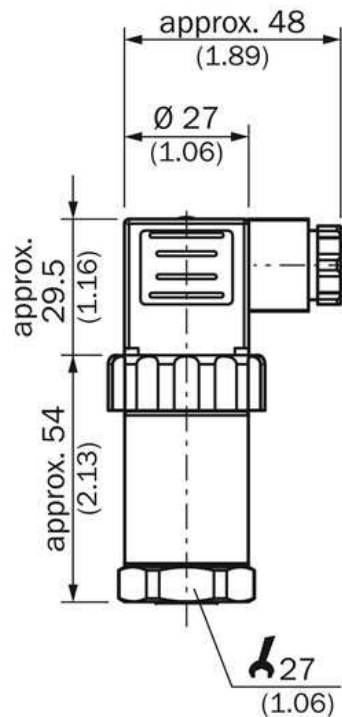

Dimensional drawing process connection

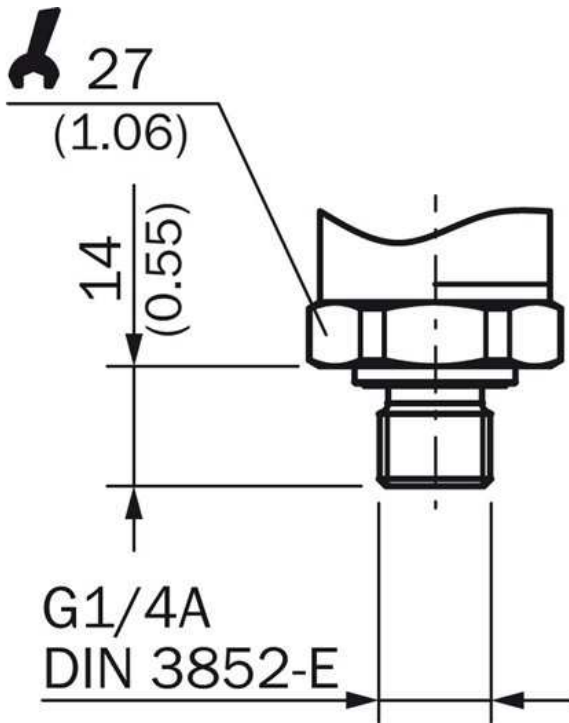

Connection type



Australia

Phone +61 3 9457 0600
1800 33 48 02 – tollfree
E-Mail sales@sick.com.au

Belgium/Luxembourg

Phone +32 (0)2 466 55 66
E-Mail info@sick.be

Brasil

Phone +55 11 3215-4900
E-Mail marketing@sick.com.br

Canada

Phone +1 905 771 14 44
E-Mail information@sick.com

Česká republika

Phone +420 2 57 91 18 50
E-Mail sick@sick.cz

China

Phone +86 4000 121 000
E-Mail info.china@sick.net.cn
Phone +852-2153 6300
E-Mail ghk@sick.com.hk

Danmark

Phone +45 45 82 64 00
E-Mail sick@sick.dk

Deutschland

Phone +49 211 5301-301
E-Mail info@sick.de

España

Phone +34 93 480 31 00
E-Mail info@sick.es

France

Phone +33 1 64 62 35 00
E-Mail info@sick.fr

Great Britain

Phone +44 (0)1727 831121
E-Mail info@sick.co.uk

India

Phone +91-22-4033 8333
E-Mail info@sick-india.com

Israel

Phone +972-4-6881000
E-Mail info@sick-sensors.com

Italia

Phone +39 02 27 43 41
E-Mail info@sick.it

Japan

Phone +81 (0)3 5309 2112
E-Mail support@sick.jp

Magyarország

Phone +36 1 371 2680
E-Mail office@sick.hu

Nederland

Phone +31 (0)30 229 25 44
E-Mail info@sick.nl

Norge

Phone +47 67 81 50 00
E-Mail sick@sick.no

Österreich

Phone +43 (0)22 36 62 28 8-0
E-Mail office@sick.at

Polska

Phone +48 22 837 40 50
E-Mail info@sick.pl

România

Phone +40 356 171 120
E-Mail office@sick.ro

Russia

Phone +7-495-775-05-30
E-Mail info@sick.ru

Schweiz

Phone +41 41 619 29 39
E-Mail contact@sick.ch

Singapore

Phone +65 6744 3732
E-Mail sales.gsg@sick.com

Slovenija

Phone +386 (0)1-47 69 990
E-Mail office@sick.si

South Africa

Phone +27 11 472 3733
E-Mail info@sickautomation.co.za

South Korea

Phone +82 2 786 6321/4
E-Mail info@sickkorea.net

Suomi

Phone +358-9-25 15 800
E-Mail sick@sick.fi

Sverige

Phone +46 10 110 10 00
E-Mail info@sick.se

Taiwan

Phone +886 2 2375-6288
E-Mail sales@sick.com.tw

Türkiye

Phone +90 (216) 528 50 00
E-Mail info@sick.com.tr

United Arab Emirates

Phone +971 (0) 4 88 65 878
E-Mail info@sick.ae

USA/México

Phone +1(952) 941-6780
1 (800) 325-7425 – tollfree
E-Mail info@sickusa.com

More representatives and agencies
at www.sick.com