



Transponder safety switches TR4 Direct Sensor & actuator

TR4-SDU03P



Model Name > [TR4-SDU03P](#)
Part No. > [6044639](#)



At a glance

- Response range of up to 25 mm
- Multicoded and unique coded sensors up to enclosure rating IP 69K
- Up to performance level PL e (EN ISO 13849)
- Two OSSD safety outputs for direct connection of sensors to a single safety controller
- Safe series connection of up to 30 sensors possible
- LED status indicator
- Boundary area indication and magnetic retaining force (both optional)
- Flexi Loop-compatible M12 plug connector (depending on variant)

Your benefits

- High level of prevention against tampering due to individually coded actuator (depending on type)
- High level of machine availability due to high tolerances for door misalignment and boundary area indication
- High level of machine reliability due to resistance to shocks and vibrations
- Cascadability of up to 30 sensors saves costs
- Long service life due to durable and low-maintenance design
- Fast diagnostics via LED status indicator
- The devices are easy to clean, making them suitable for contaminated areas or environments with strict hygiene standards
- Flexi Loop now enables a safe series connection with enhanced diagnostics capabilities and minimal wiring effort.

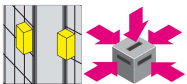

Technical data

Coding:	Unique coded
Safety integrity level:	SIL3 (IEC 61508)
Category:	category 4 (EN ISO 13849)
Performance level:	PL e (EN ISO 13849)
PFHd:	1.119 * 1E-09 (EN ISO 13849)
Electrical life:	10* 1E 06 switching cycles
TM (mission time):	20 a (EN ISO 13849)
Classification in compliance with IEC/EN 60947-5-3:	PDF-M
Housing material:	Valox® DR48
Enclosure rating:	IP 69K (DIN 40050-9), NEMA 12, NEMA 13, NEMA 3, NEMA 4X
Protection class:	III (EN 50178)

Ambient operating temperature:	-10 °C ... 55 °C
Electrical connection:	Cable
Flexi Loop-compatible plug connector:	-
Cable length:	3 m
Type of output:	Semiconductor (OSSD)
Number of safe outputs:	2
Response time:	60 ms ¹⁾
Supply voltage typical, from, to:	24 V DC, 20.4 V DC, 26.4 V DC
Safe switch on distance S_{ao} :	15 mm
Status display:	✓
Boundary area indication:	-
Magnetic retaining force:	-
Dimensions (W x H x D):	25 mm x 88 mm x 20 mm
Weight:	270 g

¹⁾ In a cascade each downstream safety switch increases the response time of the system. Other response times see operating instructions.

Response range

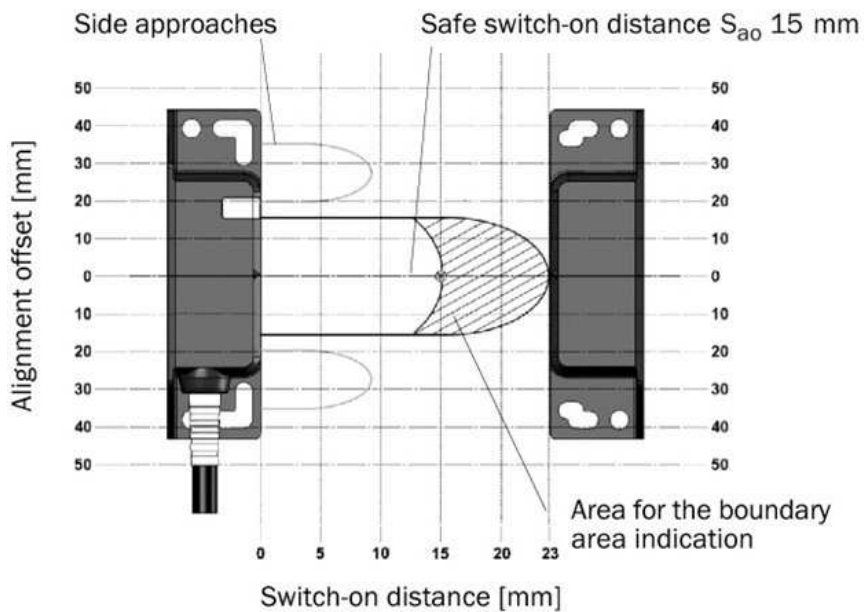

Dimensional drawing

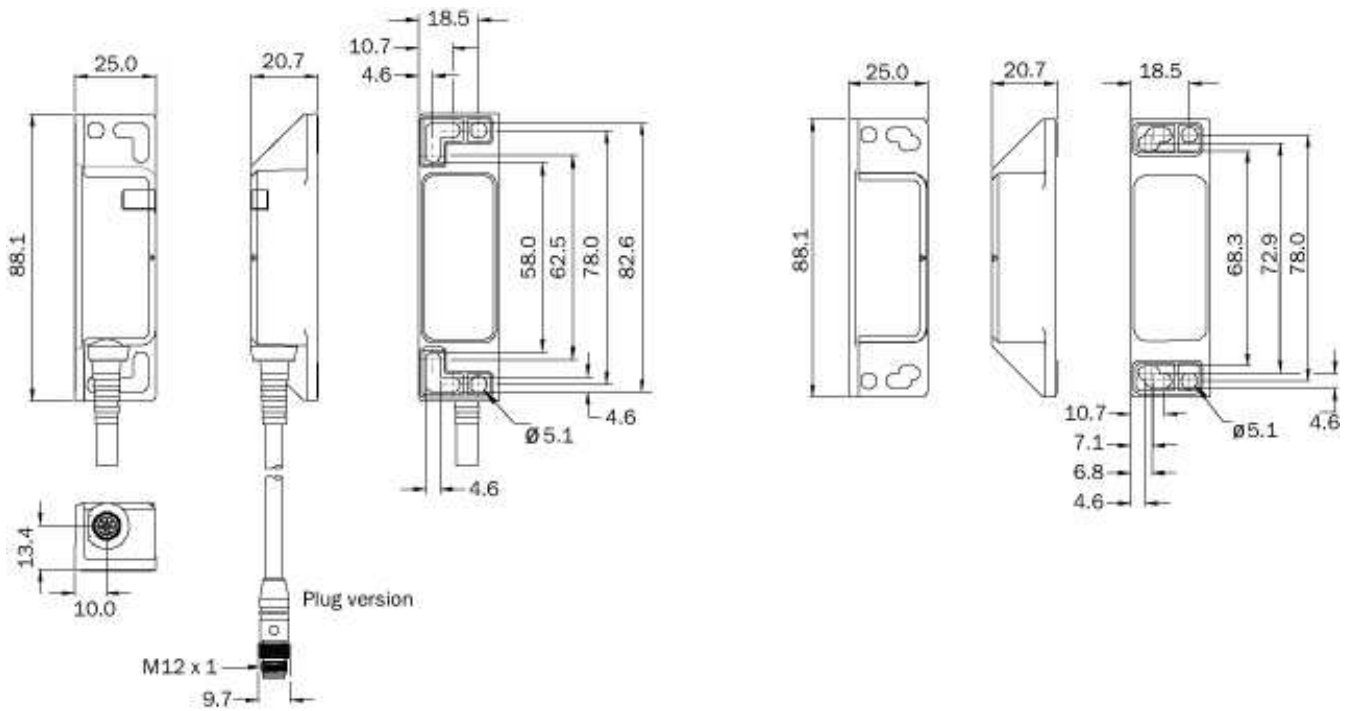

Connection diagram

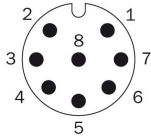

1	Aux output (not safe)
2	Voltage supply 24 V DC
3	Not connected
4	Enable input for channel B
5	Safety output A
6	Safety output B
7	Voltage supply 0 V DC
8	Enable input for channel A

Australia

Phone +61 3 9457 0600
1800 33 48 02 – tollfree
E-Mail sales@sick.com.au

Belgium/Luxembourg

Phone +32 (0)2 466 55 66
E-Mail info@sick.be

Brasil

Phone +55 11 3215-4900
E-Mail marketing@sick.com.br

Canada

Phone +1 905 771 14 44
E-Mail information@sick.com

Česká republika

Phone +420 2 57 91 18 50
E-Mail sick@sick.cz

China

Phone +86 4000 121 000
E-Mail info.china@sick.net.cn
Phone +852-2153 6300
E-Mail ghk@sick.com.hk

Danmark

Phone +45 45 82 64 00
E-Mail sick@sick.dk

Deutschland

Phone +49 211 5301-301
E-Mail info@sick.de

España

Phone +34 93 480 31 00
E-Mail info@sick.es

France

Phone +33 1 64 62 35 00
E-Mail info@sick.fr

Great Britain

Phone +44 (0)1727 831121
E-Mail info@sick.co.uk

India

Phone +91-22-4033 8333
E-Mail info@sick-india.com

Israel

Phone +972-4-6881000
E-Mail info@sick-sensors.com

Italia

Phone +39 02 27 43 41
E-Mail info@sick.it

Japan

Phone +81 (0)3 5309 2112
E-Mail support@sick.jp

Magyarország

Phone +36 1 371 2680
E-Mail office@sick.hu

Nederland

Phone +31 (0)30 229 25 44
E-Mail info@sick.nl

Norge

Phone +47 67 81 50 00
E-Mail sick@sick.no

Österreich

Phone +43 (0)22 36 62 28 8-0
E-Mail office@sick.at

Polska

Phone +48 22 837 40 50
E-Mail info@sick.pl

România

Phone +40 356 171 120
E-Mail office@sick.ro

Russia

Phone +7-495-775-05-30
E-Mail info@sick.ru

Schweiz

Phone +41 41 619 29 39
E-Mail contact@sick.ch

Singapore

Phone +65 6744 3732
E-Mail sales.gsg@sick.com

Slovenija

Phone +386 (0)1-47 69 990
E-Mail office@sick.si

South Africa

Phone +27 11 472 3733
E-Mail info@sickautomation.co.za

South Korea

Phone +82 2 786 6321/4
E-Mail info@sickkorea.net

Suomi

Phone +358-9-25 15 800
E-Mail sick@sick.fi

Sverige

Phone +46 10 110 10 00
E-Mail info@sick.se

Taiwan

Phone +886 2 2375-6288
E-Mail sales@sick.com.tw

Türkiye

Phone +90 (216) 528 50 00
E-Mail info@sick.com.tr

United Arab Emirates

Phone +971 (0) 4 88 65 878
E-Mail info@sick.ae

USA/México

Phone +1(952) 941-6780
1 (800) 325-7425 – tollfree
E-Mail info@sickusa.com

More representatives and agencies
at www.sick.com