



Flow sensors
Ultrasonic flowmeter

FFUS15-1C1IO



Model Name > **FFUS15-1C110**
Part No. > **6045162**



Illustration may differ

At a glance

- Flow sensor for conductive and non-conductive liquids
- Compact design with no moving parts
- Process temperature up to 80 °C, process pressure up to 16 bar
- High chemical resistance due to seal-free sensor design
- Large display with membrane keyboard
- Integrated teaching tube detection

Your benefits

- Reduced maintenance costs
- Adjustable measuring ranges reduces the number of variants
- Ability to be used with conductive and non-conductive liquids reduces variants and lowers storage costs
- Straight measuring tube reduces pressure loss, thus reducing energy costs
- Sensor without seals increases process reliability and availability
- Flexible measurement system for all industries



Features

Medium:	Fluids
Nominal width measuring tube:	NW 15
Process temperature:	0 °C ... +80 °C
Process pressure:	Max. 16 bar

Performance

Minimum flow:	0.9 l/min
Maximum flow:	36 l/min
Inlet zone:	30 cm
Outlet zone:	5 cm
Conductivity:	No limitation
Accuracy of sensor element:	2 % (of final value) ¹⁾
Repeatability:	≤ 0.5 %
Resolution:	0.006 l/min

¹⁾ Reference condition: water, gas-free, fully-filled measuring tube, no cavitation, Medium temperature 20 °C, ambient temperature 20 °C ... 25 °C, compliance with the inlet zone and outlet zone, warm-up time electronic: 30 min

Mechanical data

Process connection:	Clamp (DIN 11864-3)
Wetted parts:	PSU
Housing material:	PSU
Weight:	350 g
Enclosure rating:	IP 67

Electrical data

Supply voltage:	18 V DC ... 30 V DC ¹⁾
Residual ripple:	≤ 5 Vpp ²⁾
Power consumption:	≤ 180 mA ³⁾
Initialization time:	≤ 5 s
Protection class:	III
Electrical connection:	Round connector M12 x 1, 5-pin
Output signal:	Analog output: 4 mA ... 20 mA, 0 mA ... 20 mA current flow and temperature 1 pulse/status output: transistor output for flow rate meter, empty pipe detection, flow monitoring, dosing output, flow direction (depending on type)
Impuls/frequency output:	0 kHz ... 10 kHz
Puls width:	≤ 1 s
Signal voltage HIGH:	Vs - 2 V
Signal voltage LOW:	≤ 2 V
Output current:	< 100 mA ⁵⁾
Inductive load:	1 H
Capacitive load:	100 nF
Response time:	Filter off 100 ms, filter low 300 ms, filter medium 1 s, filter strong 4.2 s ⁶⁾
Output load:	< 500 Ohm
Lower signal level:	3.8 mA ... 4 mA
Upper signal level:	20 mA ... 20.5 mA

^{1) 4)} All connections are polarity protected. All outputs are overload and short-circuit protected. ²⁾ May not exceed or fall below U_v tolerances ³⁾ Without load ⁵⁾ There are 100 mA for each output pnp and npn available. ⁶⁾ Analog output and display

Ambient data

Ambient temperature operation:	0 °C ... +60 °C
Ambient storage temperature:	-20 °C ... +70 °C

Connection type

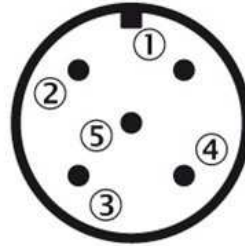
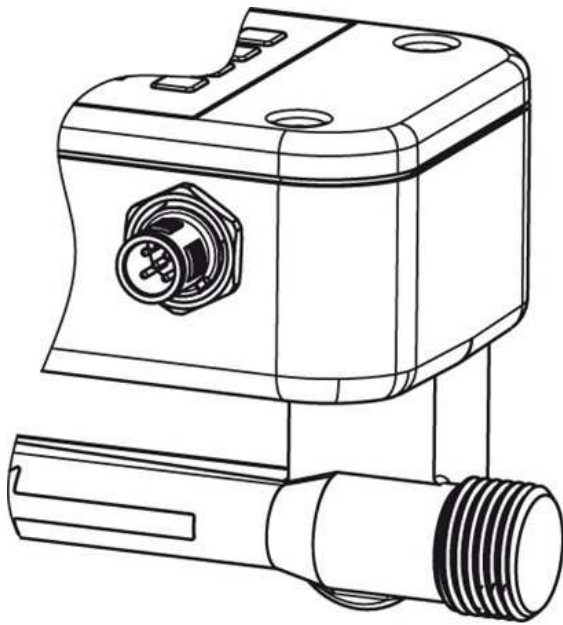

- |1| L+: Supply voltage
- |2| Q1: Digital output PNP/NPN
- |3| M: Ground
- |4| C/Q1: With IO-Link: Communication/ switching output 1
- |5| QA: Analog current output

Dimensional drawing

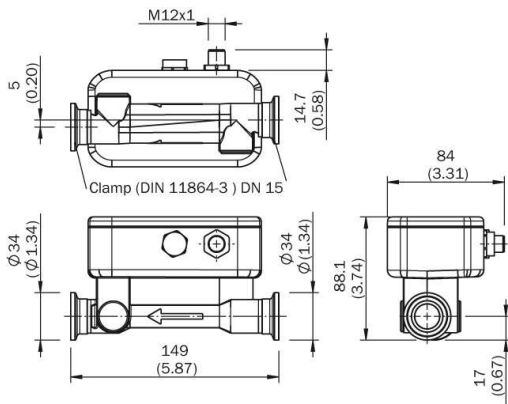

Australia

Phone +61 3 9457 0600
1800 33 48 02 – tollfree
E-Mail sales@sick.com.au

Belgium/Luxembourg

Phone +32 (0)2 466 55 66
E-Mail info@sick.be

Brasil

Phone +55 11 3215-4900
E-Mail marketing@sick.com.br

Canada

Phone +1 905 771 14 44
E-Mail information@sick.com

Česká republika

Phone +420 2 57 91 18 50
E-Mail sick@sick.cz

China

Phone +86 4000 121 000
E-Mail info.china@sick.net.cn
Phone +852-2153 6300
E-Mail ghk@sick.com.hk

Danmark

Phone +45 45 82 64 00
E-Mail sick@sick.dk

Deutschland

Phone +49 211 5301-301
E-Mail info@sick.de

España

Phone +34 93 480 31 00
E-Mail info@sick.es

France

Phone +33 1 64 62 35 00
E-Mail info@sick.fr

Great Britain

Phone +44 (0)1727 831121
E-Mail info@sick.co.uk

India

Phone +91-22-4033 8333
E-Mail info@sick-india.com

Israel

Phone +972-4-6881000
E-Mail info@sick-sensors.com

Italia

Phone +39 02 27 43 41
E-Mail info@sick.it

Japan

Phone +81 (0)3 5309 2112
E-Mail support@sick.jp

Magyarország

Phone +36 1 371 2680
E-Mail office@sick.hu

Nederland

Phone +31 (0)30 229 25 44
E-Mail info@sick.nl

Norge

Phone +47 67 81 50 00
E-Mail sick@sick.no

Österreich

Phone +43 (0)22 36 62 28 8-0
E-Mail office@sick.at

Polska

Phone +48 22 837 40 50
E-Mail info@sick.pl

România

Phone +40 356 171 120
E-Mail office@sick.ro

Russia

Phone +7-495-775-05-30
E-Mail info@sick.ru

Schweiz

Phone +41 41 619 29 39
E-Mail contact@sick.ch

Singapore

Phone +65 6744 3732
E-Mail sales.gsg@sick.com

Slovenija

Phone +386 (0)1-47 69 990
E-Mail office@sick.si

South Africa

Phone +27 11 472 3733
E-Mail info@sickautomation.co.za

South Korea

Phone +82 2 786 6321/4
E-Mail info@sickkorea.net

Suomi

Phone +358-9-25 15 800
E-Mail sick@sick.fi

Sverige

Phone +46 10 110 10 00
E-Mail info@sick.se

Taiwan

Phone +886 2 2375-6288
E-Mail sales@sick.com.tw

Türkiye

Phone +90 (216) 528 50 00
E-Mail info@sick.com.tr

United Arab Emirates

Phone +971 (0) 4 88 65 878
E-Mail info@sick.ae

USA/México

Phone +1(952) 941-6780
1 (800) 325-7425 – tollfree
E-Mail info@sickusa.com

More representatives and agencies
at www.sick.com