



Temperature sensors  
Resistance thermometer

THTS-1PAT10506MZ



**Model Name** > [THTS-1PAT10506MZ](#)  
**Part No.** > [6047588](#)



**At a glance**

- Pt100 element, accuracy class A (IEC 60751)
- Measuring ranges -50 °C ... +150 °C and -50 °C ... +250 °C
- Wetted parts: Corrosion-resistant stainless steel 316L/1.4435, Ra 0.8 µm
- Various hygienic process connections and insertion lengths
- Pt100 (4-wire) or 4 mA ... 20 mA (2-wire)
- Round connector M12 x 1

**Your benefits**

- Convenient system integration – installation in narrow installation space possible through compact dimensions
- Safe, hygienic operation due to wetted parts made from high-grade stainless steel, hygienically-graded surface finish and a gap- and crevice-free design
- Rugged: Connection housing is easily cleaned and splash proof
- Quick and safe installation
- Very good long-term stability, accuracy and linearity
- Quick response time
- Optimal solutions for individual requirements due to versatile configurability



**Features**

Measuring range:	-50 °C ... 150 °C
Sensor element:	Pt100
Output signal:	Pt100, 4-wire

**Performance**

Accuracy of sensor element:	Class A according to IEC 60751
Transmitter accuracy:	≤ ± 0.2 % of span
Transmitter linearity:	≤ ± 0.1 % of span
Response time:	Response time t50: ≤ 3.3 s <sup>1)</sup> response time t90: ≤ 9.7 s

<sup>1)</sup> Depending on sensor configuration, according to IEC 60751

**Mechanics/electronics**

Process connection:	Tri-clamp 1", 1 ½"
Insertion length/diameter of probe:	50 mm/6 mm
Housing material:	Stainless steel 1.4571 (316Ti)
Wetted parts:	stainless steel 1.4435 (316L), Ra ≤ 0.8 µm

Electrical connection/enclosure rating <sup>1)</sup>:

Measuring current:

Electrical safety:

Protection class III:

Pressure resistance:

Round connector M12 x 1, 4-pin/IP 68 and IP 69K

0.3 mA ... 1 mA

Dielectric strength: 500 V AC

Protection class: III

✓

max. 16 bar

<sup>1)</sup> Enclosure rating IP per IEC 60529. The enclosure rating classes specified only apply while the pressure transmitter is connected with female connectors that provide the corresponding enclosure rating.

### Ambient data

Ambient temperature:

-40 °C ... 85 °C

Storage and transport temperature:

-40 °C ... 85 °C

Vibration resistance according to IEC 60751:

3 g

Shock resistance:

According to IEC 60751

Relative humidity:

≤ 95 %

### Dimensional drawing process connection

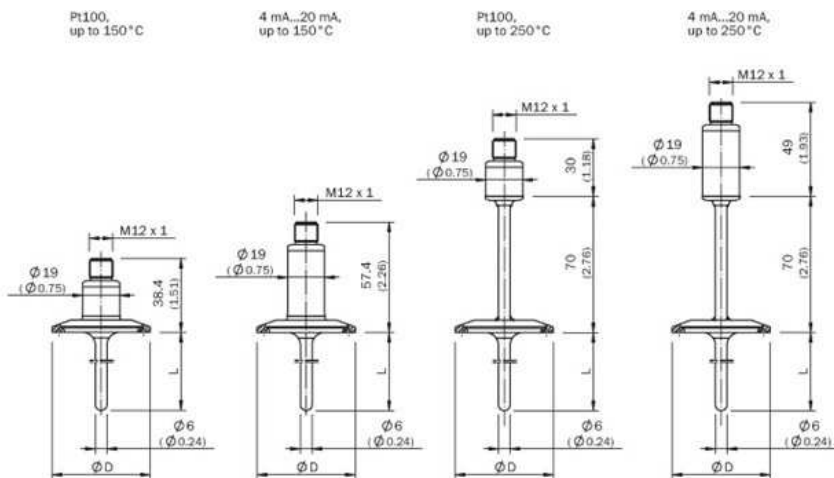

All dimensions in mm (inch)

Design		Ø D
<b>DIN 32676</b>	DN 10 ... DN 20	34.0 (1.34)
	DN 25 ... DN 40	50.5 (1.99)
	DN 50	64.0 (2.52)
<b>ISO 2852</b>	DN 12 ... DN 21.3	34.0 (1.34)
	DN 25 ... DN 38	50.5 (1.99)
	DN 40, DN 51	64.0 (2.52)
<b>Tri-Clamp</b>	1", 1 1/2"	50.5 (1.99)
	2"	64.0 (2.52)

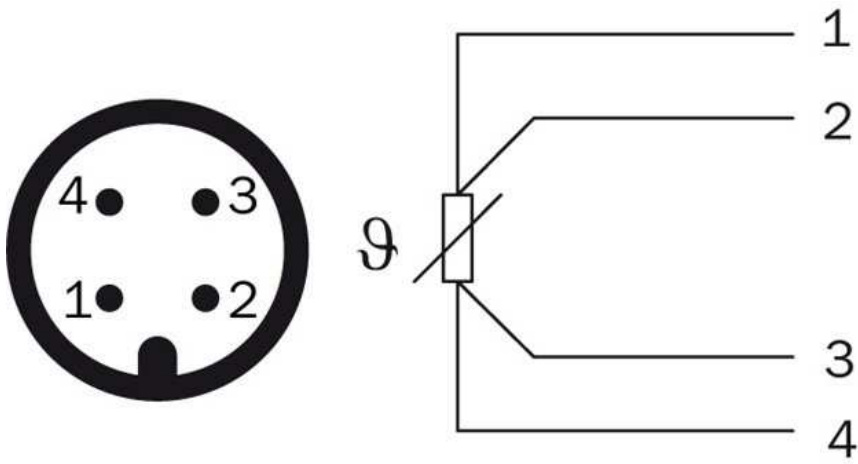

**Australia**

Phone +61 3 9457 0600  
1800 33 48 02 – tollfree  
E-Mail sales@sick.com.au

**Belgium/Luxembourg**

Phone +32 (0)2 466 55 66  
E-Mail info@sick.be

**Brasil**

Phone +55 11 3215-4900  
E-Mail marketing@sick.com.br

**Canada**

Phone +1 905 771 14 44  
E-Mail information@sick.com

**Česká republika**

Phone +420 2 57 91 18 50  
E-Mail sick@sick.cz

**China**

Phone +86 4000 121 000  
E-Mail info.china@sick.net.cn  
Phone +852-2153 6300  
E-Mail ghk@sick.com.hk

**Danmark**

Phone +45 45 82 64 00  
E-Mail sick@sick.dk

**Deutschland**

Phone +49 211 5301-301  
E-Mail info@sick.de

**España**

Phone +34 93 480 31 00  
E-Mail info@sick.es

**France**

Phone +33 1 64 62 35 00  
E-Mail info@sick.fr

**Great Britain**

Phone +44 (0)1727 831121  
E-Mail info@sick.co.uk

**India**

Phone +91-22-4033 8333  
E-Mail info@sick-india.com

**Israel**

Phone +972-4-6881000  
E-Mail info@sick-sensors.com

**Italia**

Phone +39 02 27 43 41  
E-Mail info@sick.it

**Japan**

Phone +81 (0)3 5309 2112  
E-Mail support@sick.jp

**Magyarország**

Phone +36 1 371 2680  
E-Mail office@sick.hu

**Nederland**

Phone +31 (0)30 229 25 44  
E-Mail info@sick.nl

**Norge**

Phone +47 67 81 50 00  
E-Mail sick@sick.no

**Österreich**

Phone +43 (0)22 36 62 28 8-0  
E-Mail office@sick.at

**Polska**

Phone +48 22 837 40 50  
E-Mail info@sick.pl

**România**

Phone +40 356 171 120  
E-Mail office@sick.ro

**Russia**

Phone +7-495-775-05-30  
E-Mail info@sick.ru

**Schweiz**

Phone +41 41 619 29 39  
E-Mail contact@sick.ch

**Singapore**

Phone +65 6744 3732  
E-Mail sales.gsg@sick.com

**Slovenija**

Phone +386 (0)1-47 69 990  
E-Mail office@sick.si

**South Africa**

Phone +27 11 472 3733  
E-Mail info@sickautomation.co.za

**South Korea**

Phone +82 2 786 6321/4  
E-Mail info@sickkorea.net

**Suomi**

Phone +358-9-25 15 800  
E-Mail sick@sick.fi

**Sverige**

Phone +46 10 110 10 00  
E-Mail info@sick.se

**Taiwan**

Phone +886 2 2375-6288  
E-Mail sales@sick.com.tw

**Türkiye**

Phone +90 (216) 528 50 00  
E-Mail info@sick.com.tr

**United Arab Emirates**

Phone +971 (0) 4 88 65 878  
E-Mail info@sick.ae

**USA/México**

Phone +1(952) 941-6780  
1 (800) 325-7425 – tollfree  
E-Mail info@sickusa.com

More representatives and agencies  
at [www.sick.com](http://www.sick.com)