



Temperature sensors
Resistance thermometer

THTS-1PA540256MZ



Model Name > [THTS-1PA540256MZ](#)
Part No. > [6047594](#)



At a glance

- Pt100 element, accuracy class A (IEC 60751)
- Measuring ranges -50 °C ... +150 °C and -50 °C ... +250 °C
- Wetted parts: Corrosion-resistant stainless steel 316L/1.4435, Ra 0.8 µm
- Various hygienic process connections and insertion lengths
- Pt100 (4-wire) or 4 mA ... 20 mA (2-wire)
- Round connector M12 x 1

Your benefits

- Convenient system integration – installation in narrow installation space possible through compact dimensions
- Safe, hygienic operation due to wetted parts made from high-grade stainless steel, hygienically-graded surface finish and a gap- and crevice-free design
- Rugged: Connection housing is easily cleaned and splash proof
- Quick and safe installation
- Very good long-term stability, accuracy and linearity
- Quick response time
- Optimal solutions for individual requirements due to versatile configurability



Features

Measuring range:	-50 °C ... 150 °C
Sensor element:	Pt100
Output signal:	Pt100, 4-wire

Performance

Accuracy of sensor element:	Class A according to IEC 60751
Transmitter accuracy:	≤ ± 0.2 % of span
Transmitter linearity:	≤ ± 0.1 % of span
Response time:	Response time t50: ≤ 3.3 s ¹⁾ response time t90: ≤ 9.7 s

¹⁾ Depending on sensor configuration, according to IEC 60751

Mechanics/electronics

Process connection:	Conical coupling (DIN 11851) DN 40 with union nut
Insertion length/diameter of probe:	25 mm/6 mm
Housing material:	Stainless steel 1.4571 (316Ti)
Wetted parts:	stainless steel 1.4435 (316L), Ra ≤ 0.8 µm

Electrical connection/enclosure rating ¹⁾:

Measuring current:

Electrical safety:

Protection class III:

Pressure resistance:

Round connector M12 x 1, 4-pin/IP 68 and IP 69K

0.3 mA ... 1 mA

Dielectric strength: 500 V AC

Protection class: III

✓

max. 40 bar

¹⁾ Enclosure rating IP per IEC 60529. The enclosure rating classes specified only apply while the pressure transmitter is connected with female connectors that provide the corresponding enclosure rating.

Ambient data

Ambient temperature:

-40 °C ... 85 °C

Storage and transport temperature:

-40 °C ... 85 °C

Vibration resistance according to IEC 60751:

3 g

Shock resistance:

According to IEC 60751

Relative humidity:

≤ 95 %

Dimensional drawing process connection

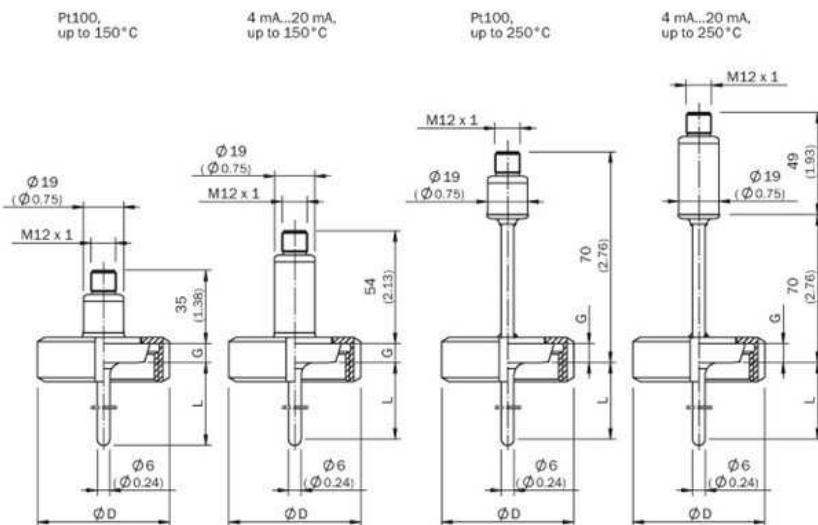

All dimensions in mm (inch)

Design		Ø D	G
DIN 11851	DN 20	54.0 (2.13)	8 (0.31)
	DN 25	63.0 (2.48)	10 (0.39)
	DN 32	70.0 (2.76)	10 (0.39)
	DN 40	78.0 (3.07)	10 (0.39)
	DN 50	92.0 (3.62)	11 (0.43)

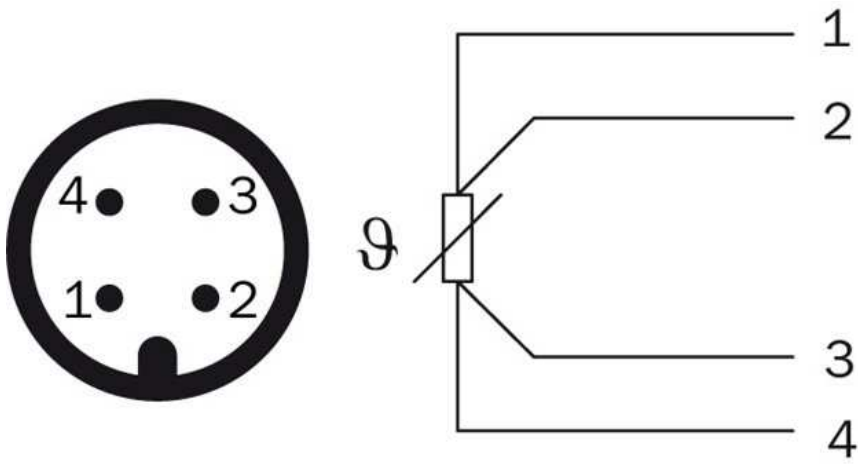

Australia

Phone +61 3 9457 0600
1800 33 48 02 – tollfree
E-Mail sales@sick.com.au

Belgium/Luxembourg

Phone +32 (0)2 466 55 66
E-Mail info@sick.be

Brasil

Phone +55 11 3215-4900
E-Mail marketing@sick.com.br

Canada

Phone +1 905 771 14 44
E-Mail information@sick.com

Česká republika

Phone +420 2 57 91 18 50
E-Mail sick@sick.cz

China

Phone +86 4000 121 000
E-Mail info.china@sick.net.cn
Phone +852-2153 6300
E-Mail ghk@sick.com.hk

Danmark

Phone +45 45 82 64 00
E-Mail sick@sick.dk

Deutschland

Phone +49 211 5301-301
E-Mail info@sick.de

España

Phone +34 93 480 31 00
E-Mail info@sick.es

France

Phone +33 1 64 62 35 00
E-Mail info@sick.fr

Great Britain

Phone +44 (0)1727 831121
E-Mail info@sick.co.uk

India

Phone +91-22-4033 8333
E-Mail info@sick-india.com

Israel

Phone +972-4-6881000
E-Mail info@sick-sensors.com

Italia

Phone +39 02 27 43 41
E-Mail info@sick.it

Japan

Phone +81 (0)3 5309 2112
E-Mail support@sick.jp

Magyarország

Phone +36 1 371 2680
E-Mail office@sick.hu

Nederland

Phone +31 (0)30 229 25 44
E-Mail info@sick.nl

Norge

Phone +47 67 81 50 00
E-Mail sick@sick.no

Österreich

Phone +43 (0)22 36 62 28 8-0
E-Mail office@sick.at

Polska

Phone +48 22 837 40 50
E-Mail info@sick.pl

România

Phone +40 356 171 120
E-Mail office@sick.ro

Russia

Phone +7-495-775-05-30
E-Mail info@sick.ru

Schweiz

Phone +41 41 619 29 39
E-Mail contact@sick.ch

Singapore

Phone +65 6744 3732
E-Mail sales.gsg@sick.com

Slovenija

Phone +386 (0)1-47 69 990
E-Mail office@sick.si

South Africa

Phone +27 11 472 3733
E-Mail info@sickautomation.co.za

South Korea

Phone +82 2 786 6321/4
E-Mail info@sickkorea.net

Suomi

Phone +358-9-25 15 800
E-Mail sick@sick.fi

Sverige

Phone +46 10 110 10 00
E-Mail info@sick.se

Taiwan

Phone +886 2 2375-6288
E-Mail sales@sick.com.tw

Türkiye

Phone +90 (216) 528 50 00
E-Mail info@sick.com.tr

United Arab Emirates

Phone +971 (0) 4 88 65 878
E-Mail info@sick.ae

USA/México

Phone +1(952) 941-6780
1 (800) 325-7425 – tollfree
E-Mail info@sickusa.com

More representatives and agencies
at www.sick.com