



Safety controllers
Motion Control module, Standstill Monitor

MOC3ZA-KAZ34D3



Model Name > [MOC3ZA-KAZ34D3](#)
Part No. > [6047866](#)



At a glance

- Standstill monitoring by means of residual voltage measurement
- 3 normally open and 1 normally closed positively guided safety contacts
- 2 application diagnostic outputs for semiconductors
- 1 application diagnostic output normally open
- PL e (EN ISO 13849), SIL3 (IEC 61508), SILCL 3 (EN 62061)
- Maximum motor supply voltage 690 V
- Adjustable voltage threshold and standstill period

Your benefits

- Quick mounting and installation thanks to the lack of additional wiring requirements
- Simple commissioning with a screwdriver
- Easy to retrofit as the subsequent mounting of sensors is not necessary



Safety-related parameters

Safety integrity level:	SIL3 (IEC 61508) SILCL3 (EN 62061)
Category:	Category 4 (EN ISO 13849-1)
Performance level:	PL e (EN ISO 13849-1)
PFHd:	41 * 1E-09 (EN ISO 13849)
TM (mission time):	20 a (EN ISO 13849)
Safe state in the event of a fault:	The N/O is open; in other words, the safety-related enabling current paths are interrupted.
Stop category:	1 (EN 60204-1)

Functions

Standstill:	✓
-------------	---

Mechanical data

Dimensions (W x H x D):	45 mm x 112 mm x 121 mm
Weight:	400 g
Mounting:	35 mm mounting rail according to EN 60715

Electrical data

Mechanical life:	≥ 50 * 1E 06 switching operations
Contact configuration (safety contacts):	3 contacts NO, 1 contact NC

Power consumption:	4 W
Supply voltage semiconductor diagnostic outputs (A3/A4):	24 V DC (11 V DC ... 30 V DC)
Measurement inputs:	L1/L2/L3
Measured/motor voltage:	690 V AC
For UL 508 applications only:	600 V AC
Voltage threshold Uan:	20 mV ... 400 mV, adjustable
Standstill time ts:	0.2 s ... 6 s, adjustable
Hysteresis (for detection of running motor):	100 %
Response time:	100 ms
Positively guided N/C contacts:	Normally closed contact (41/42)
Contact type:	Relay, positively guided
Nominal switching voltage:	250 V AC
Switching capacity in accordance with AC 15:	N/C: 2 A/230 V AC (EN 60947-5-1), N/O: 3 A/230 V AC (EN 60947-5-1)
Switching capacity in accordance with DC 13:	2 A/24 V DC (EN 60947-5-1)
Maximum switching frequency:	1,200 /h
Contact service life at 230 V/5 A (AC) $\cos \varphi = 0.5$:	$\geq 2 * 1E 05$ switching operations
Semiconductor application diagnostics outputs (ON, ERR):	Electrically isolated supply via A3/A4, I _{max} = 100 mA (short-circuit protected), ON for Release, ERR for Error
Signal contacts 53/54 (normally open contact):	3 A/250 V AC G. P.
Safety outputs:	Normally open contact (13/14, 23/24, 33/34)

Ambient data

Protection class housing:	IP 40
Enclosure rating terminals:	IP 20
Climate conditions according to:	25/060/04 (EN 60068-1)
Vibration resistance:	(EN 60068-2-6)

Connection diagram

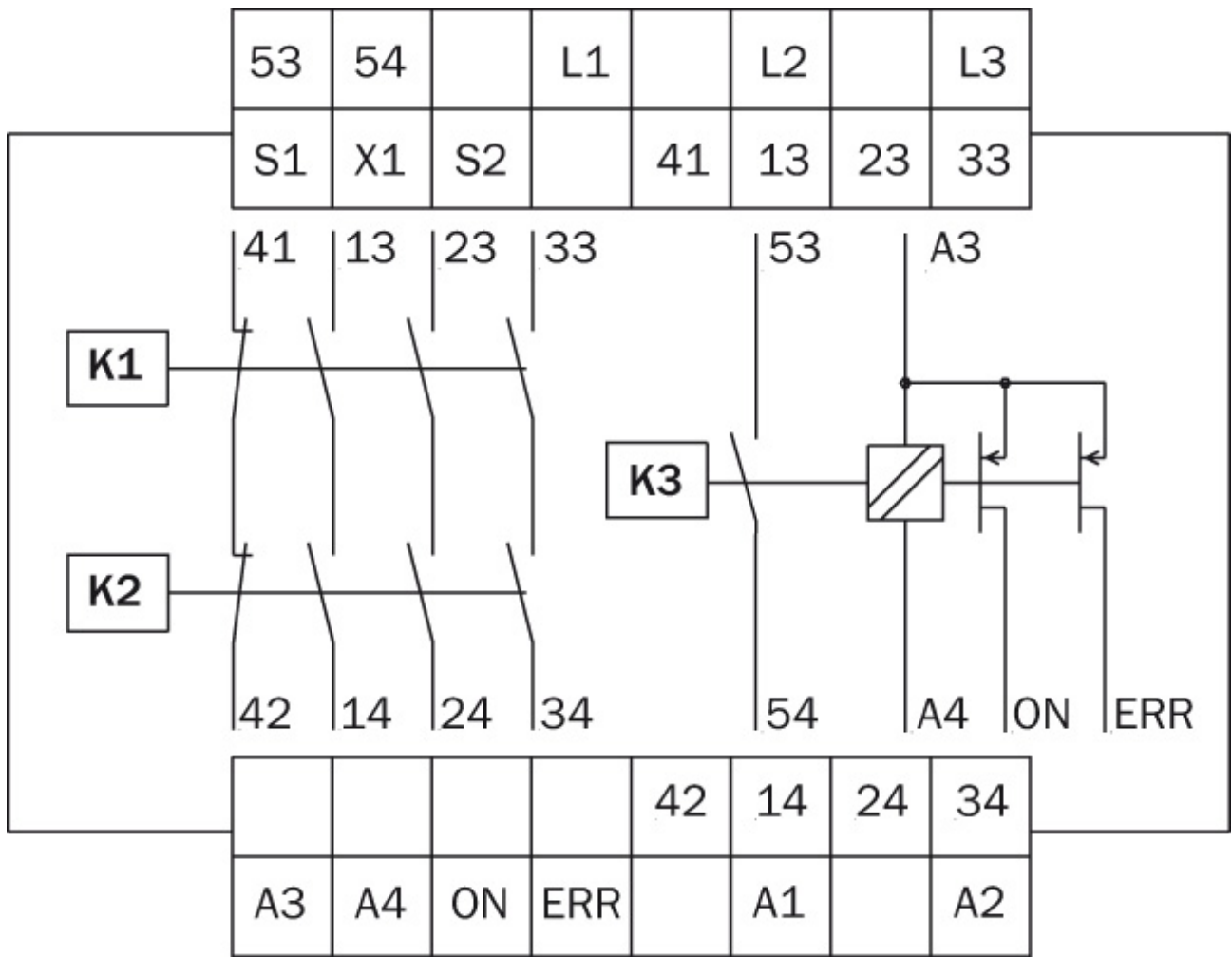

Dimensional drawing

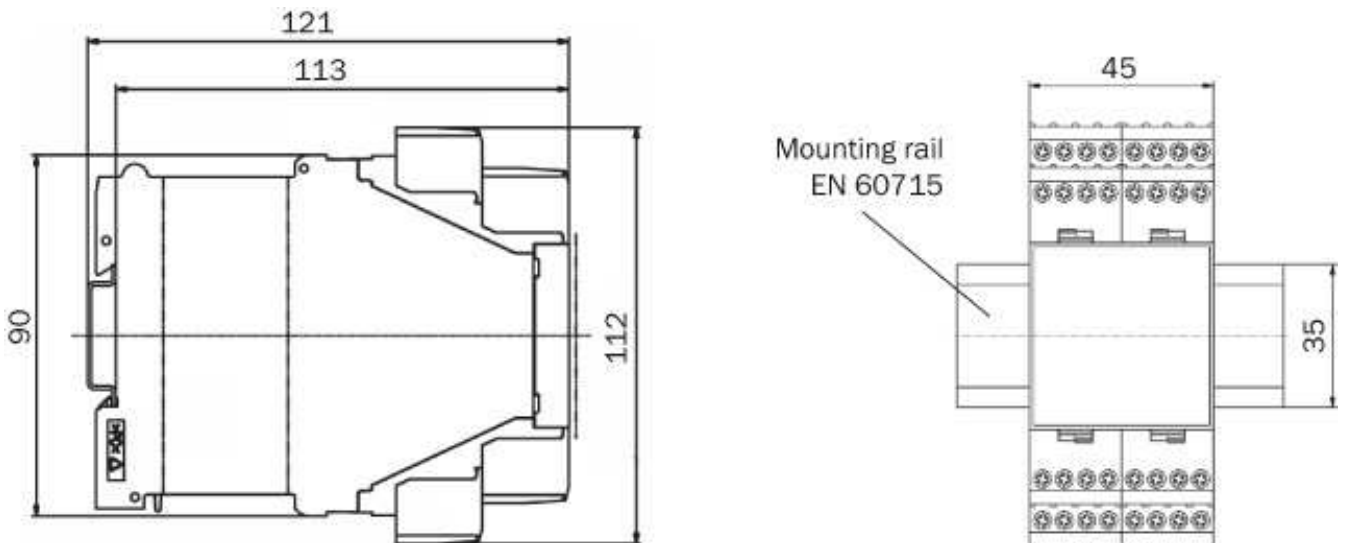

Device overview and connections

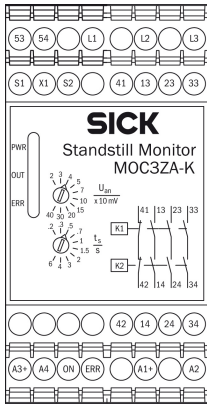

Australia

Phone +61 3 9457 0600
1800 33 48 02 – tollfree
E-Mail sales@sick.com.au

Belgium/Luxembourg

Phone +32 (0)2 466 55 66
E-Mail info@sick.be

Brasil

Phone +55 11 3215-4900
E-Mail marketing@sick.com.br

Canada

Phone +1 905 771 14 44
E-Mail information@sick.com

Česká republika

Phone +420 2 57 91 18 50
E-Mail sick@sick.cz

China

Phone +86 4000 121 000
E-Mail info.china@sick.net.cn
Phone +852-2153 6300
E-Mail ghk@sick.com.hk

Danmark

Phone +45 45 82 64 00
E-Mail sick@sick.dk

Deutschland

Phone +49 211 5301-301
E-Mail info@sick.de

España

Phone +34 93 480 31 00
E-Mail info@sick.es

France

Phone +33 1 64 62 35 00
E-Mail info@sick.fr

Great Britain

Phone +44 (0)1727 831121
E-Mail info@sick.co.uk

India

Phone +91-22-4033 8333
E-Mail info@sick-india.com

Israel

Phone +972-4-6881000
E-Mail info@sick-sensors.com

Italia

Phone +39 02 27 43 41
E-Mail info@sick.it

Japan

Phone +81 (0)3 5309 2112
E-Mail support@sick.jp

Magyarország

Phone +36 1 371 2680
E-Mail office@sick.hu

Nederland

Phone +31 (0)30 229 25 44
E-Mail info@sick.nl

Norge

Phone +47 67 81 50 00
E-Mail sick@sick.no

Österreich

Phone +43 (0)22 36 62 28 8-0
E-Mail office@sick.at

Polska

Phone +48 22 837 40 50
E-Mail info@sick.pl

România

Phone +40 356 171 120
E-Mail office@sick.ro

Russia

Phone +7-495-775-05-30
E-Mail info@sick.ru

Schweiz

Phone +41 41 619 29 39
E-Mail contact@sick.ch

Singapore

Phone +65 6744 3732
E-Mail sales.gsg@sick.com

Slovenija

Phone +386 (0)1-47 69 990
E-Mail office@sick.si

South Africa

Phone +27 11 472 3733
E-Mail info@sickautomation.co.za

South Korea

Phone +82 2 786 6321/4
E-Mail info@sickkorea.net

Suomi

Phone +358-9-25 15 800
E-Mail sick@sick.fi

Sverige

Phone +46 10 110 10 00
E-Mail info@sick.se

Taiwan

Phone +886 2 2375-6288
E-Mail sales@sick.com.tw

Türkiye

Phone +90 (216) 528 50 00
E-Mail info@sick.com.tr

United Arab Emirates

Phone +971 (0) 4 88 65 878
E-Mail info@sick.ae

USA/México

Phone +1(952) 941-6780
1 (800) 325-7425 – tollfree
E-Mail info@sickusa.com

More representatives and agencies
at www.sick.com