



Temperature sensors
Resistance thermometer

TBS-1ASG10506NM



Model Name > [TBS-1ASG10506NM](#)
Part No. > [6048661](#)



At a glance

- Large display
- Individually programmable transistor outputs PNP or NPN, optional analog output 4 mA ... 20 mA or 0 V ... 10 V
- Round connector M12 x 1
- Measuring ranges -20 °C ... +80 °C
- Pt1000 element, accuracy class A (IEC 60751)
- Various insertion lengths and connection threads
- Wetted parts made from corrosion-resistant stainless steel 1.4571
- Enclosure rating IP 65 and IP 67

Your benefits

- Quick and safe set-up through superior ease of use
- Compact dimensions and rotatable housing facilitate integration
- Very reliable: splash-proof housing, high-grade materials, rugged design, and field-proven technology
- Very good long-term stability, accuracy and linearity
- Quick response time
- Versatile configuration allows for optimal solutions for specific requirements



Features

Measuring range:	-20 °C ... 80 °C
Sensor element:	Pt1000, 2-wire, class A according to IEC 60751
Output signals:	2 x PNP
Output type:	Transistor
Switching output function:	Normally open/normally closed, windows- and hysteresis function freely adjustable
Switching voltage:	Supply voltage [V DC] - 1 V DC
Maximum switching current:	250 mA
Switching delay:	0 s ... 50 s, programmable
Setting accuracy of switching outputs:	0.1 °C
Temperature offset:	± 3 °C
Messbereichskalierung:	Zero point: max. +25 % of span Full scale: max. -25 % of span

Display:	14-segment LED, blue, 4-digits, height 9 mm, display electronically turnable by 180 °, update: 200 ms
Rotatable housing:	Display against housing with electrical connection: 330 °, Housing against process connection: 320 °

Performance

Accuracy of sensor element:	$\leq \pm (0.15 \text{ °C} + 0.002 t)$ ¹⁾
Accuracy of switching output:	$\leq \pm 0.8 \%$ of span
Display accuracy:	$\leq \pm 0.8 \%$ of span ± 1 digit
Response time t50:	$\leq 5 \text{ s}$ ²⁾
Response time t90:	$\leq 10 \text{ s}$ ³⁾

¹⁾ |t| is the absolute value of the temperature in °C ^{2) 3)} Depending on sensor configuration, according to IEC 60751.

Mechanics/electronics

Process connection:	Thread G 1/4 A according to DIN 3852-E
Insertion length/diameter of probe:	50 mm/6 mm
Housing material:	Lower body: stainless steel 1.4301 (AISI 304) Plastic head: PC + ABS Input keypad: TPE-E Display window: PC
Wetted parts:	Stainless steel 1.4571 (AISI 316Ti)
Supply voltage:	15 V DC ... 35 V DC
CE-conformity:	2004/108/EC, EN 61326-1 emission (group 1, class B) and interference immunity (industrial application)
Maximum power consumption:	45 mA
Seal:	NBR ¹⁾
Maximum process pressure:	150 bar ¹⁾
Enclosure rating::	IP 65, according to IEC 60529 ^{2) 3)} IP 67, according to IEC 60529 ^{2) 3)}
Electrical connection:	Round connector M12 x 1, 4-pin
Maximum ohmic load RA:	$\leq 100 \text{ k}\Omega$ (Switching outputs)
Total current consumption:	570 mA (incl. switching current) 320 mA
Protection class:	III
Isolation voltage:	500 V DC
Overvoltage protection:	40 V DC
Short-circuit protection:	Outputs QA, Q1, Q2 towards M
Reverse polarity protection:	L+ towards M
RoHS certificate:	✓

¹⁾ At room temperature and when connected through thread. ^{2) 3)} The enclosure rating classes specified only apply while the thermometer is connected with female connectors that provide the corresponding enclosure rating.

Ambient data

Ambient temperature:	-20 °C ... 80 °C
Storage and transport temperature:	-20 °C ... 80 °C
Relative humidity:	45 % ... 75 %

Dimensional drawing

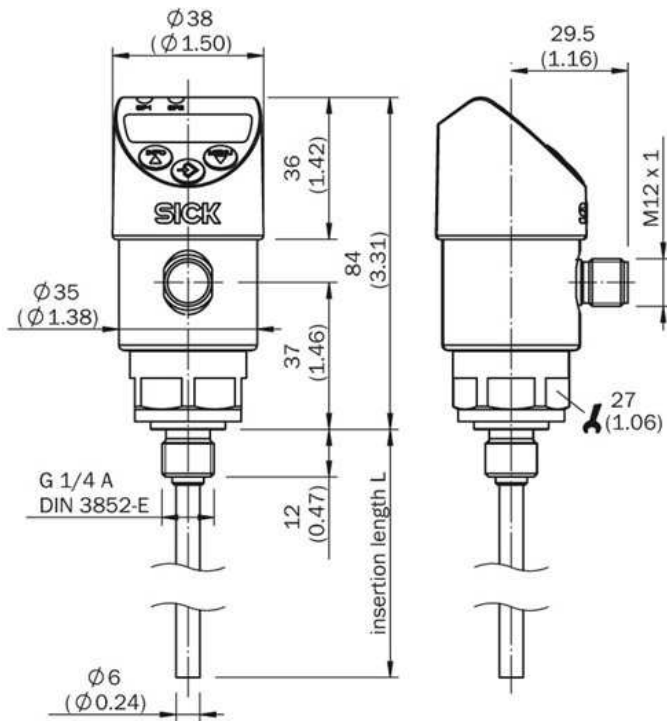

Connection type

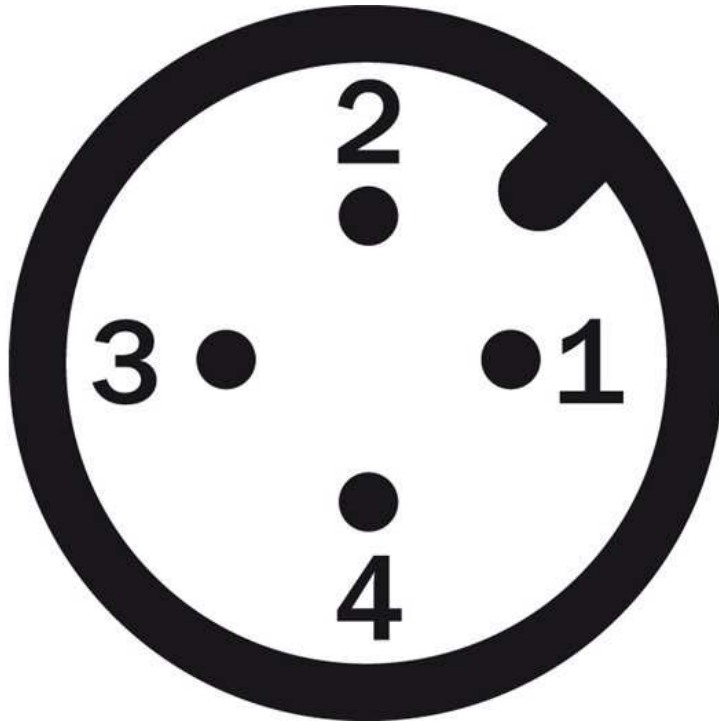

- |1| L+
- |2| QA/Q2, type-dependent
- |3| M
- |4| Q1

Australia

Phone +61 3 9457 0600
1800 33 48 02 – tollfree
E-Mail sales@sick.com.au

Belgium/Luxembourg

Phone +32 (0)2 466 55 66
E-Mail info@sick.be

Brasil

Phone +55 11 3215-4900
E-Mail marketing@sick.com.br

Canada

Phone +1 905 771 14 44
E-Mail information@sick.com

Česká republika

Phone +420 2 57 91 18 50
E-Mail sick@sick.cz

China

Phone +86 4000 121 000
E-Mail info.china@sick.net.cn
Phone +852-2153 6300
E-Mail ghk@sick.com.hk

Danmark

Phone +45 45 82 64 00
E-Mail sick@sick.dk

Deutschland

Phone +49 211 5301-301
E-Mail info@sick.de

España

Phone +34 93 480 31 00
E-Mail info@sick.es

France

Phone +33 1 64 62 35 00
E-Mail info@sick.fr

Great Britain

Phone +44 (0)1727 831121
E-Mail info@sick.co.uk

India

Phone +91-22-4033 8333
E-Mail info@sick-india.com

Israel

Phone +972-4-6881000
E-Mail info@sick-sensors.com

Italia

Phone +39 02 27 43 41
E-Mail info@sick.it

Japan

Phone +81 (0)3 5309 2112
E-Mail support@sick.jp

Magyarország

Phone +36 1 371 2680
E-Mail office@sick.hu

Nederland

Phone +31 (0)30 229 25 44
E-Mail info@sick.nl

Norge

Phone +47 67 81 50 00
E-Mail sick@sick.no

Österreich

Phone +43 (0)22 36 62 28 8-0
E-Mail office@sick.at

Polska

Phone +48 22 837 40 50
E-Mail info@sick.pl

România

Phone +40 356 171 120
E-Mail office@sick.ro

Russia

Phone +7-495-775-05-30
E-Mail info@sick.ru

Schweiz

Phone +41 41 619 29 39
E-Mail contact@sick.ch

Singapore

Phone +65 6744 3732
E-Mail sales.gsg@sick.com

Slovenija

Phone +386 (0)1-47 69 990
E-Mail office@sick.si

South Africa

Phone +27 11 472 3733
E-Mail info@sickautomation.co.za

South Korea

Phone +82 2 786 6321/4
E-Mail info@sickkorea.net

Suomi

Phone +358-9-25 15 800
E-Mail sick@sick.fi

Sverige

Phone +46 10 110 10 00
E-Mail info@sick.se

Taiwan

Phone +886 2 2375-6288
E-Mail sales@sick.com.tw

Türkiye

Phone +90 (216) 528 50 00
E-Mail info@sick.com.tr

United Arab Emirates

Phone +971 (0) 4 88 65 878
E-Mail info@sick.ae

USA/México

Phone +1(952) 941-6780
1 (800) 325-7425 – tollfree
E-Mail info@sickusa.com

More representatives and agencies
at www.sick.com