



Pressure sensors
Pressure switch

PBSH-RB2X5SHGEED5A0Z



Model Name > **PBSH-RB2X5SHGEED5A0Z**
Part No. > **6051861**



Illustration may differ

At a glance

- Hygienically-graded pressure switch with display for the food and beverage industry
- Wetted parts are made from stainless steel 1.4435
- Individually programmable switching outputs and analog output
- Pressure values are indicated on the display
- Unit of pressure value in the display can be switched
- Output states are indicated separately via large LEDs

Your benefits

- Safe hygienic operation due to flush-mounted, highly resistant stainless steel membrane and hygienic process connections
- Suitability for CIP and SIP ensures high system availability
- Safe and easy setup with three large pushbuttons and legible, rotatable display
- Rotatable housing for optimum cable routing
- Wide range of available configurations enable customer-specific solutions
- High reliability: Corrosion-resistant design of wetted parts and housing with IP 65 and IP 67 enclosure ratings
- Ultimate system availability: IO-Link enables fast, reliable parameter setting when changing over products



Features

Pressure type:	Gauge pressure
Measuring range:	0 bar ... 2.5 bar
Process temperature:	-20 °C ... +125 °C, +150 °C for max. 1 h ¹⁾
Display:	14-segment-LED, blue, 4-digits, height 9 mm, electronically turnable by 180°, Update: 1,000, 500, 200, 100 ms (adjustable), Accuracy: ≤ 1 % of span ± 1 digit
Output signal:	2 x PNP + 4 mA ... 20 mA
Rotatable housing:	Display against housing with electrical connection: 330 °, Housing against process connection: 320 °
Maximum ohmic load RA:	≤ 0.5 kΩ
Gauge pressure:	0 bar ... 1 bar up to 0 bar ... 25 bar
Absolute pressure:	0 bar ... 1 bar up to 0 bar ... 25 bar
Compound pressure:	-1 bar ... 0 bar up to -1 bar ... +24 bar
Overpressure safety:	2-fold
Zero point adjustment:	Max. + 3 % of span
Medium:	Liquid and gaseous media

1) Only for process connection G 1 hygienic

Performance

Accuracy:	$\leq \pm 1 \%$ of span (Including non-linearity, hysteresis, zero point and full scale error (corresponds to error of measurement according to IEC 61298-2))
Non-linearity:	$\leq \pm 0.5 \%$ (of span (Best Fit Straight Line, BFSL) according to IEC 61298-2)
Setting accuracy of switching outputs:	$\leq \pm 0.5 \%$ of span
Response time:	3 ms
Long-term drift/one-year stability:	$\leq \pm 0.2 \%$ of span according to IEC 61298-2
Temperature coefficient in rated temperature range:	Typical TC of zero: In the temperature range 0 °C ... 20 °C: 0.7 % of span /10 K. In the temperature range 20 °C ... 80 °C: 0.2 % of span/10 K. typical TC of span: In the temperature range 0 °C ... 80 °C: 0.1 % of the span/10 K
Rated temperature range:	0 °C ... +80 °C

Mechanics/electronics

Process connection:	G 1 hygienic flush-mounted
Wetted parts:	Stainless steel 1.4435/316L
Seal:	Wetted parts: EPDM, Not wetted parts: EPDM
Housing material:	Display window: PC, Plastic head: PC + ABS, Buttons: TPE-E, Lower body: stainless steel 304
Enclosure rating:	IP 65/IP 67
Electrical connection:	Round connector M12 x 1, 5-pin
Power consumption:	Max. 70 mA
Electrical safety:	Short-circuit protection: QA, Q1, Q2 towards M, Protection class: III, Overvoltage protection: 40 V DC, Reverse polarity protection: L+ towards M
Protection class III:	✓
Internal transmission fluid:	Medical white oil, FDA compliant according to CFR 172.878 and 21 CFR 178.3620(a), compliant to USP, EP, and JP
Total current consumption:	Max. 570 mA (incl. switching current)
Isolation voltage:	500 V DC
CE-conformity:	EMC directive: 2004/108/EC, EN 61326-2-3

Ambient data

Storage temperature:	-20 °C ... +80 °C
Ambient temperature:	-20 °C ... +80 °C
Shock load:	50 g according to IEC 60068-2-27 (mechanical shock)
Vibration load:	10 g according to IEC 60068-2-6 (vibration under resonance)
Relative humidity:	45 % ... 75 %

Connection type

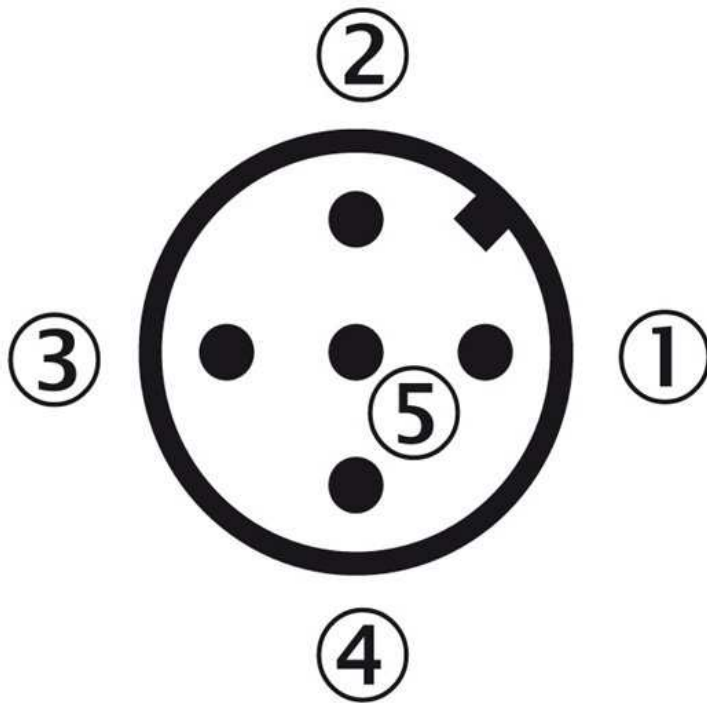

- |1| L+: Positive supply connection
- |2| Q2: Switching output 2
- |3| M: Negative supply connection
- |4| C/Q1: Switching output 1 (with IO-Link: communication / switching output 1)
- |5| QA: Analog output

Dimensional drawing

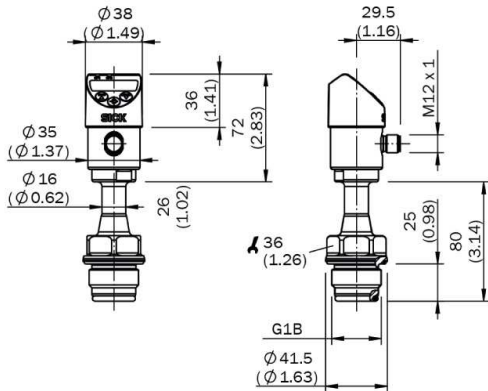

Australia

Phone +61 3 9457 0600
1800 33 48 02 – tollfree
E-Mail sales@sick.com.au

Belgium/Luxembourg

Phone +32 (0)2 466 55 66
E-Mail info@sick.be

Brasil

Phone +55 11 3215-4900
E-Mail marketing@sick.com.br

Canada

Phone +1 905 771 14 44
E-Mail information@sick.com

Česká republika

Phone +420 2 57 91 18 50
E-Mail sick@sick.cz

China

Phone +86 4000 121 000
E-Mail info.china@sick.net.cn
Phone +852-2153 6300
E-Mail ghk@sick.com.hk

Danmark

Phone +45 45 82 64 00
E-Mail sick@sick.dk

Deutschland

Phone +49 211 5301-301
E-Mail info@sick.de

España

Phone +34 93 480 31 00
E-Mail info@sick.es

France

Phone +33 1 64 62 35 00
E-Mail info@sick.fr

Great Britain

Phone +44 (0)1727 831121
E-Mail info@sick.co.uk

India

Phone +91-22-4033 8333
E-Mail info@sick-india.com

Israel

Phone +972-4-6881000
E-Mail info@sick-sensors.com

Italia

Phone +39 02 27 43 41
E-Mail info@sick.it

Japan

Phone +81 (0)3 5309 2112
E-Mail support@sick.jp

Magyarország

Phone +36 1 371 2680
E-Mail office@sick.hu

Nederland

Phone +31 (0)30 229 25 44
E-Mail info@sick.nl

Norge

Phone +47 67 81 50 00
E-Mail sick@sick.no

Österreich

Phone +43 (0)22 36 62 28 8-0
E-Mail office@sick.at

Polska

Phone +48 22 837 40 50
E-Mail info@sick.pl

România

Phone +40 356 171 120
E-Mail office@sick.ro

Russia

Phone +7-495-775-05-30
E-Mail info@sick.ru

Schweiz

Phone +41 41 619 29 39
E-Mail contact@sick.ch

Singapore

Phone +65 6744 3732
E-Mail sales.gsg@sick.com

Slovenija

Phone +386 (0)1-47 69 990
E-Mail office@sick.si

South Africa

Phone +27 11 472 3733
E-Mail info@sickautomation.co.za

South Korea

Phone +82 2 786 6321/4
E-Mail info@sickkorea.net

Suomi

Phone +358-9-25 15 800
E-Mail sick@sick.fi

Sverige

Phone +46 10 110 10 00
E-Mail info@sick.se

Taiwan

Phone +886 2 2375-6288
E-Mail sales@sick.com.tw

Türkiye

Phone +90 (216) 528 50 00
E-Mail info@sick.com.tr

United Arab Emirates

Phone +971 (0) 4 88 65 878
E-Mail info@sick.ae

USA/México

Phone +1(952) 941-6780
1 (800) 325-7425 – tollfree
E-Mail info@sickusa.com

More representatives and agencies
at www.sick.com