



Pressure sensors  
Pressure switch

PBSH-RB025SHGEED5A0Z



**Model Name** > **PBSH-RB025SHGEED5A0Z**  
**Part No.** > **6051864**



*Illustration may differ*

**At a glance**

- Hygienically-graded pressure switch with display for the food and beverage industry
- Wetted parts are made from stainless steel 1.4435
- Individually programmable switching outputs and analog output
- Pressure values are indicated on the display
- Unit of pressure value in the display can be switched
- Output states are indicated separately via large LEDs

**Your benefits**

- Safe hygienic operation due to flush-mounted, highly resistant stainless steel membrane and hygienic process connections
- Suitability for CIP and SIP ensures high system availability
- Safe and easy setup with three large pushbuttons and legible, rotatable display
- Rotatable housing for optimum cable routing
- Wide range of available configurations enable customer-specific solutions
- High reliability: Corrosion-resistant design of wetted parts and housing with IP 65 and IP 67 enclosure ratings
- Ultimate system availability: IO-Link enables fast, reliable parameter setting when changing over products



**Features**

Pressure type:	Gauge pressure
Measuring range:	0 bar ... 25 bar
Process temperature:	-20 °C ... +125 °C, +150 °C for max. 1 h <sup>1)</sup>
Display:	14-segment-LED, blue, 4-digits, height 9 mm, electronically turnable by 180°, Update: 1,000, 500, 200, 100 ms (adjustable), Accuracy: ≤ 1 % of span ± 1 digit
Output signal:	2 x PNP + 4 mA ... 20 mA
Rotatable housing:	Display against housing with electrical connection: 330 °, Housing against process connection: 320 °
Maximum ohmic load RA:	≤ 0.5 kΩ
Gauge pressure:	0 bar ... 1 bar up to 0 bar ... 25 bar
Absolute pressure:	0 bar ... 1 bar up to 0 bar ... 25 bar
Compound pressure:	-1 bar ... 0 bar up to -1 bar ... +24 bar
Overpressure safety:	2-fold
Zero point adjustment:	Max. + 3 % of span
Medium:	Liquid and gaseous media

1) Only for process connection G 1 hygienic

## Performance

---

Accuracy:	$\leq \pm 1\%$ of span (Including non-linearity, hysteresis, zero point and full scale error (corresponds to error of measurement according to IEC 61298-2))
Non-linearity:	$\leq \pm 0.5\%$ (of span (Best Fit Straight Line, BFSL) according to IEC 61298-2)
Setting accuracy of switching outputs:	$\leq \pm 0.5\%$ of span
Response time:	3 ms
Long-term drift/one-year stability:	$\leq \pm 0.2\%$ of span according to IEC 61298-2
Temperature coefficient in rated temperature range:	Typical TC of zero: In the temperature range 0 °C ... 20 °C: 0.7 % of span /10 K. In the temperature range 20 °C ... 80 °C: 0.2 % of span/10 K. typical TC of span: In the temperature range 0 °C ... 80 °C: 0.1 % of the span/10 K
Rated temperature range:	0 °C ... +80 °C

## Mechanics/electronics

---

Process connection:	G 1 hygienic flush-mounted
Wetted parts:	Stainless steel 1.4435/316L
Seal:	Wetted parts: EPDM, Not wetted parts: EPDM
Housing material:	Display window: PC, Plastic head: PC + ABS, Buttons: TPE-E, Lower body: stainless steel 304
Enclosure rating:	IP 65/IP 67
Electrical connection:	Round connector M12 x 1, 5-pin
Power consumption:	Max. 70 mA
Electrical safety:	Short-circuit protection: QA, Q1, Q2 towards M, Protection class: III, Overvoltage protection: 40 V DC, Reverse polarity protection: L+ towards M
Protection class III:	✓
Internal transmission fluid:	Medical white oil, FDA compliant according to CFR 172.878 and 21 CFR 178.3620(a), compliant to USP, EP, and JP
Total current consumption:	Max. 570 mA (incl. switching current)
Isolation voltage:	500 V DC
CE-conformity:	EMC directive: 2004/108/EC, EN 61326-2-3

## Ambient data

---

Storage temperature:	-20 °C ... +80 °C
Ambient temperature:	-20 °C ... +80 °C
Shock load:	50 g according to IEC 60068-2-27 (mechanical shock)
Vibration load:	10 g according to IEC 60068-2-6 (vibration under resonance)
Relative humidity:	45 % ... 75 %

## Connection type

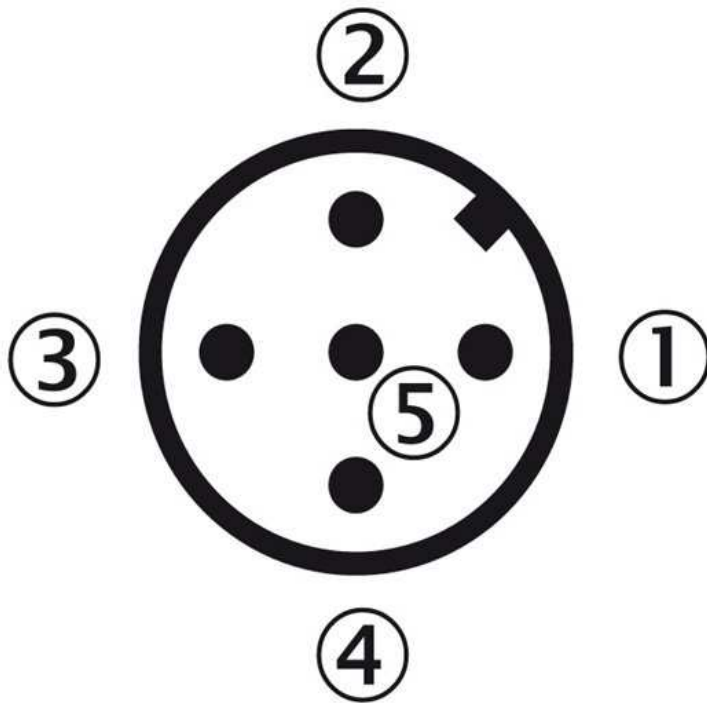

- |1| L+: Positive supply connection
- |2| Q2: Switching output 2
- |3| M: Negative supply connection
- |4| C/Q1: Switching output 1 (with IO-Link: communication / switching output 1)
- |5| QA: Analog output

## Dimensional drawing

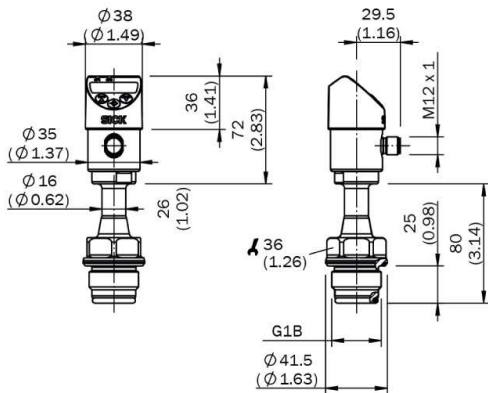

**Australia**

Phone +61 3 9457 0600  
1800 33 48 02 – tollfree  
E-Mail sales@sick.com.au

**Belgium/Luxembourg**

Phone +32 (0)2 466 55 66  
E-Mail info@sick.be

**Brasil**

Phone +55 11 3215-4900  
E-Mail marketing@sick.com.br

**Canada**

Phone +1 905 771 14 44  
E-Mail information@sick.com

**Česká republika**

Phone +420 2 57 91 18 50  
E-Mail sick@sick.cz

**China**

Phone +86 4000 121 000  
E-Mail info.china@sick.net.cn  
Phone +852-2153 6300  
E-Mail ghk@sick.com.hk

**Danmark**

Phone +45 45 82 64 00  
E-Mail sick@sick.dk

**Deutschland**

Phone +49 211 5301-301  
E-Mail info@sick.de

**España**

Phone +34 93 480 31 00  
E-Mail info@sick.es

**France**

Phone +33 1 64 62 35 00  
E-Mail info@sick.fr

**Great Britain**

Phone +44 (0)1727 831121  
E-Mail info@sick.co.uk

**India**

Phone +91-22-4033 8333  
E-Mail info@sick-india.com

**Israel**

Phone +972-4-6881000  
E-Mail info@sick-sensors.com

**Italia**

Phone +39 02 27 43 41  
E-Mail info@sick.it

**Japan**

Phone +81 (0)3 5309 2112  
E-Mail support@sick.jp

**Magyarország**

Phone +36 1 371 2680  
E-Mail office@sick.hu

**Nederland**

Phone +31 (0)30 229 25 44  
E-Mail info@sick.nl

**Norge**

Phone +47 67 81 50 00  
E-Mail sick@sick.no

**Österreich**

Phone +43 (0)22 36 62 28 8-0  
E-Mail office@sick.at

**Polska**

Phone +48 22 837 40 50  
E-Mail info@sick.pl

**România**

Phone +40 356 171 120  
E-Mail office@sick.ro

**Russia**

Phone +7-495-775-05-30  
E-Mail info@sick.ru

**Schweiz**

Phone +41 41 619 29 39  
E-Mail contact@sick.ch

**Singapore**

Phone +65 6744 3732  
E-Mail sales.gsg@sick.com

**Slovenija**

Phone +386 (0)1-47 69 990  
E-Mail office@sick.si

**South Africa**

Phone +27 11 472 3733  
E-Mail info@sickautomation.co.za

**South Korea**

Phone +82 2 786 6321/4  
E-Mail info@sickkorea.net

**Suomi**

Phone +358-9-25 15 800  
E-Mail sick@sick.fi

**Sverige**

Phone +46 10 110 10 00  
E-Mail info@sick.se

**Taiwan**

Phone +886 2 2375-6288  
E-Mail sales@sick.com.tw

**Türkiye**

Phone +90 (216) 528 50 00  
E-Mail info@sick.com.tr

**United Arab Emirates**

Phone +971 (0) 4 88 65 878  
E-Mail info@sick.ae

**USA/México**

Phone +1(952) 941-6780  
1 (800) 325-7425 – tollfree  
E-Mail info@sickusa.com

More representatives and agencies  
at [www.sick.com](http://www.sick.com)