



Inductive proximity sensors
Cylindrical smooth housing, IH06

IH06-02BPS-VT1



Model Name > [IH06-02BPS-VT1](#)
Part No. > [7900179](#)



At a glance

- Operating distance of up to 4 mm
- High switching frequency
- Short-circuit protection (pulsed)
- IP 67 enclosure rating
- Stainless steel housing
- LED status indicator

Your benefits

- Reliable detection of high-speed processes increases machine throughput
- High-visibility indicator LED ensures simple monitoring of the operational state
- High resistance to shock and vibrations increases service life and reduces maintenance and replacement costs



Features

| | |
|---------------------------|---------------------|
| Design: | Cylindrical |
| Diameter: | 6.5 mm |
| Sensing range Sn: | 2 mm |
| Assured sensing range Sa: | 1.62 mm |
| Installation type: | Flush |
| Switching frequency: | 5,000 Hz |
| Output type: | PNP |
| Output function: | NO |
| Electrical wiring: | DC 3-wire |
| Enclosure rating: | IP 67 ¹⁾ |
| Electrical connection: | Connector M8, 3-pin |
| Housing: | Standard |

¹⁾ According to EN 60529

Mechanics/electronics

| | |
|---------------------------------|-----------------------|
| Supply voltage: | 10 V DC ... 30 V DC |
| Residual ripple: | ≤ 10 % ¹⁾ |
| Voltage drop: | ≤ 1.8 V ²⁾ |
| Power consumption: | ≤ 10 mA ³⁾ |
| Time delay before availability: | ≤ 50 ms |
| Hysteresis: | 1 % ... 20 % |

| | |
|---------------------------------|---|
| Repeatability: | ≤ 5 % ^{4) 5)} |
| Temperature drift (of Sr): | ± 10 % |
| EMC: | According to EN 60947-5-2 |
| Output current I _a : | ≤ 200 mA |
| Short-circuit protection: | ✓ |
| Reverse polarity protection: | ✓ |
| Power-up pulse protection: | ✓ |
| Shock and vibration resistance: | 30 g, 11 ms/10 ... 55 Hz, 1 mm |
| Ambient temperature operation: | -25 °C ... 70 °C |
| Housing material: | Stainless steel, Stainless steel (V2A, 304) |
| Housing cap material: | Plastic, PBT |
| Housing length: | 50 mm |

1) Of V_S ²⁾ With I_a = 200 mA ³⁾ Without load ⁴⁾ U_b = 20 V DC ... 30 V DC, T_a = 23 °C ± 5 °C ⁵⁾ Of Sr

Reduction factors

| | |
|-----------------------------|--|
| Note: | The values are reference values which may vary |
| Stainless steel (V2A, 304): | Ca. 0.6 |
| Copper (Cu): | Ca. 0.1 |
| Aluminum (Al): | Ca. 0.17 |
| Brass (Br): | Ca. 0.25 |

Installation note

| | |
|---------|---------------------------------------|
| A: | 3.25 mm |
| B: | 6,5 mm |
| C: | 6,5 mm |
| D: | 6 mm |
| E: | 4 mm |
| F: | 16 mm |
| Remark: | Associated graphic see "Installation" |

Installation note

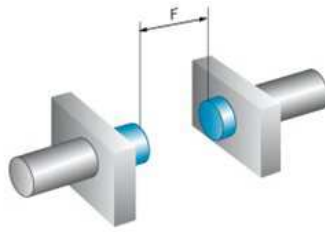
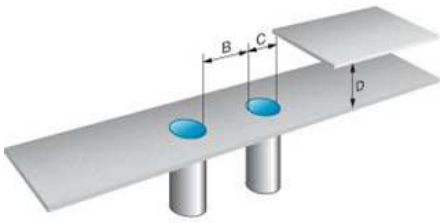

Installation note non-flush installation

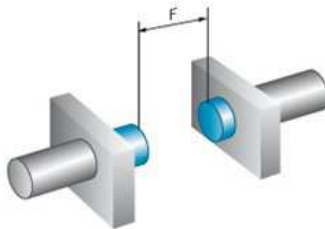
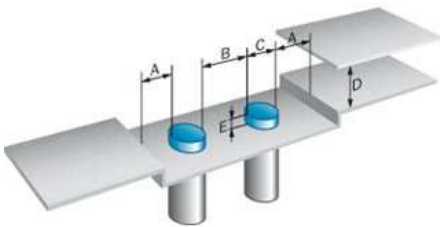

Dimensional drawing

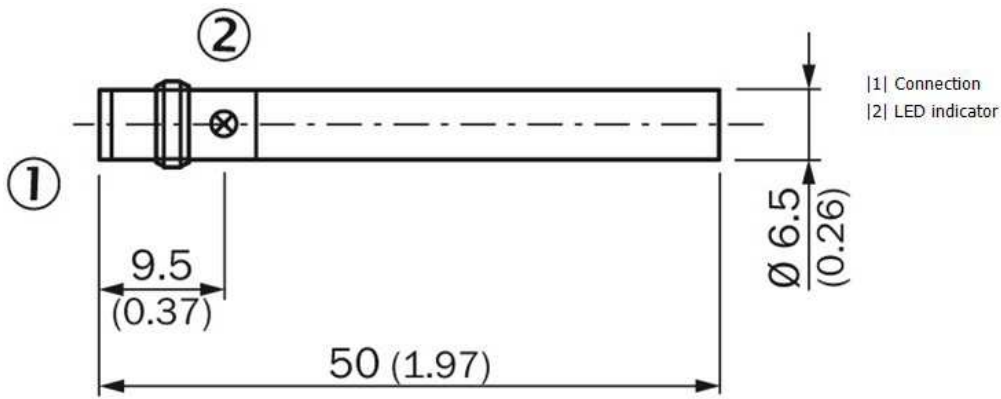

All dimensions in mm (inch)

Connection diagram

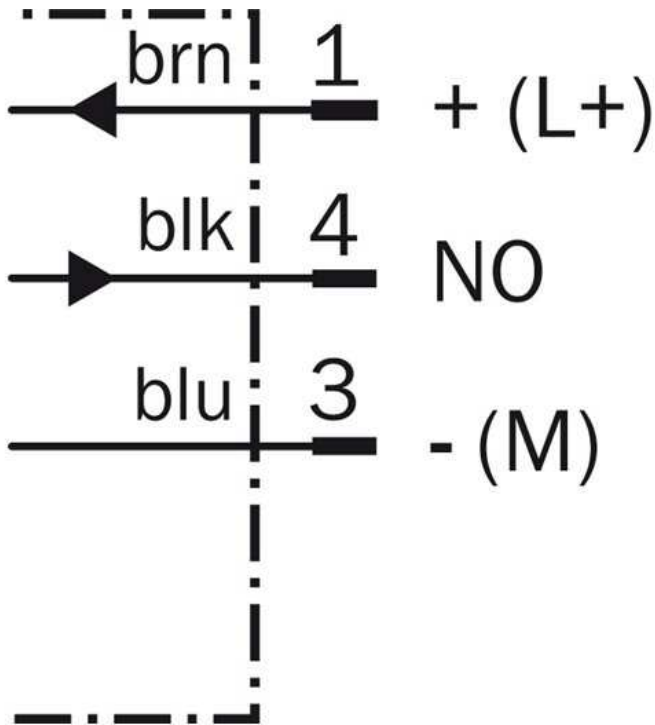

Connection type

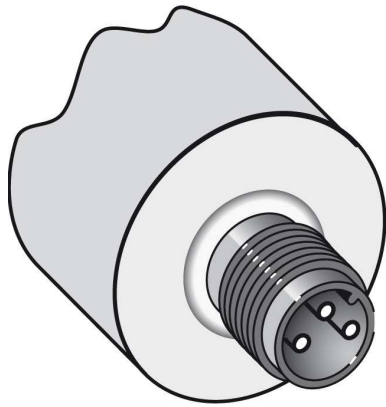

Australia

Phone +61 3 9457 0600
1800 33 48 02 – tollfree
E-Mail sales@sick.com.au

Belgium/Luxembourg

Phone +32 (0)2 466 55 66
E-Mail info@sick.be

Brasil

Phone +55 11 3215-4900
E-Mail marketing@sick.com.br

Canada

Phone +1 905 771 14 44
E-Mail information@sick.com

Česká republika

Phone +420 2 57 91 18 50
E-Mail sick@sick.cz

China

Phone +86 4000 121 000
E-Mail info.china@sick.net.cn
Phone +852-2153 6300
E-Mail ghk@sick.com.hk

Danmark

Phone +45 45 82 64 00
E-Mail sick@sick.dk

Deutschland

Phone +49 211 5301-301
E-Mail info@sick.de

España

Phone +34 93 480 31 00
E-Mail info@sick.es

France

Phone +33 1 64 62 35 00
E-Mail info@sick.fr

Great Britain

Phone +44 (0)1727 831121
E-Mail info@sick.co.uk

India

Phone +91-22-4033 8333
E-Mail info@sick-india.com

Israel

Phone +972-4-6881000
E-Mail info@sick-sensors.com

Italia

Phone +39 02 27 43 41
E-Mail info@sick.it

Japan

Phone +81 (0)3 5309 2112
E-Mail support@sick.jp

Magyarország

Phone +36 1 371 2680
E-Mail office@sick.hu

Nederland

Phone +31 (0)30 229 25 44
E-Mail info@sick.nl

Norge

Phone +47 67 81 50 00
E-Mail sick@sick.no

Österreich

Phone +43 (0)22 36 62 28 8-0
E-Mail office@sick.at

Polska

Phone +48 22 837 40 50
E-Mail info@sick.pl

România

Phone +40 356 171 120
E-Mail office@sick.ro

Russia

Phone +7-495-775-05-30
E-Mail info@sick.ru

Schweiz

Phone +41 41 619 29 39
E-Mail contact@sick.ch

Singapore

Phone +65 6744 3732
E-Mail sales.gsg@sick.com

Slovenija

Phone +386 (0)1-47 69 990
E-Mail office@sick.si

South Africa

Phone +27 11 472 3733
E-Mail info@sickautomation.co.za

South Korea

Phone +82 2 786 6321/4
E-Mail info@sickkorea.net

Suomi

Phone +358-9-25 15 800
E-Mail sick@sick.fi

Sverige

Phone +46 10 110 10 00
E-Mail info@sick.se

Taiwan

Phone +886 2 2375-6288
E-Mail sales@sick.com.tw

Türkiye

Phone +90 (216) 528 50 00
E-Mail info@sick.com.tr

United Arab Emirates

Phone +971 (0) 4 88 65 878
E-Mail info@sick.ae

USA/México

Phone +1(952) 941-6780
1 (800) 325-7425 – tollfree
E-Mail info@sickusa.com

More representatives and agencies
at www.sick.com