

Pressure Sensors for Highest Pressures

Accuracy 0.5%

Standard output: 4...20 mA - 2-wire system
or 0...10 VDC - 3-wire system



Description

Pressure sensors for highest pressures are top of the range among pressure sensors. They are impressive due to the flexible construction of both their electrical and their mechanical connections and in the field of highest pressure measurement they provide the user with the perfect solution to the measuring task in hand.

Long-term stability, peak pressure resistance, corrosion-resistance and a high level of mechanical safety make them suitable for these demanding measuring tasks.

The graduated measuring ranges cover from 0 ... 1600 bar up to the high pressure range of 0 ... 15000 bar. The case and wetted parts are made from stainless steel and are thus resistant to chemically aggressive media.

The measuring cell clamped to the pressure connection by means of a sealing cone guarantees a very high loading capacity. A relief bore ensures a defined escape for the media in the direction of the pressure connection in the event of damage.

Optionally available are a replaceable process connection and a cavitation module for highly dynamic measuring tasks.

Shape A DIN EN 175301-803 plugs with junction box, round connectors M12 x 1 (4-pin) or a cable outlet are provided to pick up the electrical output signals.

Pressure sensors for highest pressures meet the electromagnetic compatibility (EMC) requirements in accordance with EN 61326.

Features

- High peak pressure resistance
- High alternating load resistance
- High long-term stability
- Mechanical safety design
- Corrosion-resistant stainless steel design
- Optional cavitation module
- Replaceable process connection

Measuring ranges

Gauge pressure

positive 0...1600 bar to 0...15000 bar

Applications

- Autofrettage
- Highest pressure cleaning
- Highest pressure pasteurisation
- Hydroforming
- LDPE systems
- Testing systems for bursting pressure
- Water-jet cutting device

Model: P3298

Technical Data

Model range	P3298	Option
Type of pressure	Positive gauge pressure	
Output signal	4...20 mA - 2-wire system 0...10 VDC - 3-wire system	Others on request
Accuracy	0.5 % of FS ¹⁾	0.5 % of FS on request
Measuring ranges to EN	0... 1600 bar 0... 2500 bar 0... 4000 bar 0... 5000 bar 0... 6000 bar 0... 7000 bar 0... 8000 bar 0 ... 10000 bar	>10000 bar on request
Sensor element	thin film	
Reproducibility	≤ ± 0.05 % of FS	
Stability per year	≤ ± 0.1 % of FS in rated conditions	
Housing	stainless steel	
Wetted parts	stainless steel	
RoHS conformity	on request	
Overload limit	≤ 5000 bar 1.2-fold; > 5000 bar 1.1-fold;	
Electr. connection	plug to DIN EN 175301-803 shape A with junction box round connectors M12x1 (4-pin)	Cable outlet with 1.5 m cable
Power supply	14...30 VDC, (10...30 VDC for output 4 ... 20 mA)	
Isolation voltage	500 VDC	
Load		
– 4...20 mA	$R_A[\Omega] \leq (U_B[V]-10V)/0.02A$	
– 0...5 V	> 5 kΩ	
– 0...10 V	> 10 kΩ	
Temperature comp. range	0 ... 80°C	
Temperature influence	≤ 1% typical , max. 2.5% in compensated range	
Zero point controllability	± 5% (by means of potentiometer on device)	
Response time	≤ 1 ms (within 10% to 90% of FS)	
Protection type (to IEC 60 529)	IP65 for plug DIN EN 175301-803 shape A IP67 for round connector M12x1	IP 67 for cable outlet
CE conformity		
– Pressure vessels directive	97/23/EC	
– EMC directive	2004/108/EC, EN 61326 Emission (Group 1, Class B) and Interference (industrial area)	
Shock resistance	100g (2.4ms) to IEC 60068-2-27	
Vibration resistance	0.35 (10 ... 55Hz) to IEC 60068-2-6	
Electr. protection types	polarity, overvoltage and short-circuit protection	
Temperature ranges		
– storage	-40 ... 85 °C	
– media	0 ... 80 °C	
– ambient	-20 ... 80 °C	
Weight	approx. 0.3 kg	

of FS = of full scale value

- 1) Terminal point adjustment includes non-linearity, hysteresis, zero point and limit value deviation.
- 2) Declaration of Conformity on request

Dimensions (mm)

Housing

Plug module
DIN EN 175301-803 shape A

Round connector
M12 x 1

Cable outlet
with 1.5 m long (PUR)

with optional cavitation
and pressure peak protection

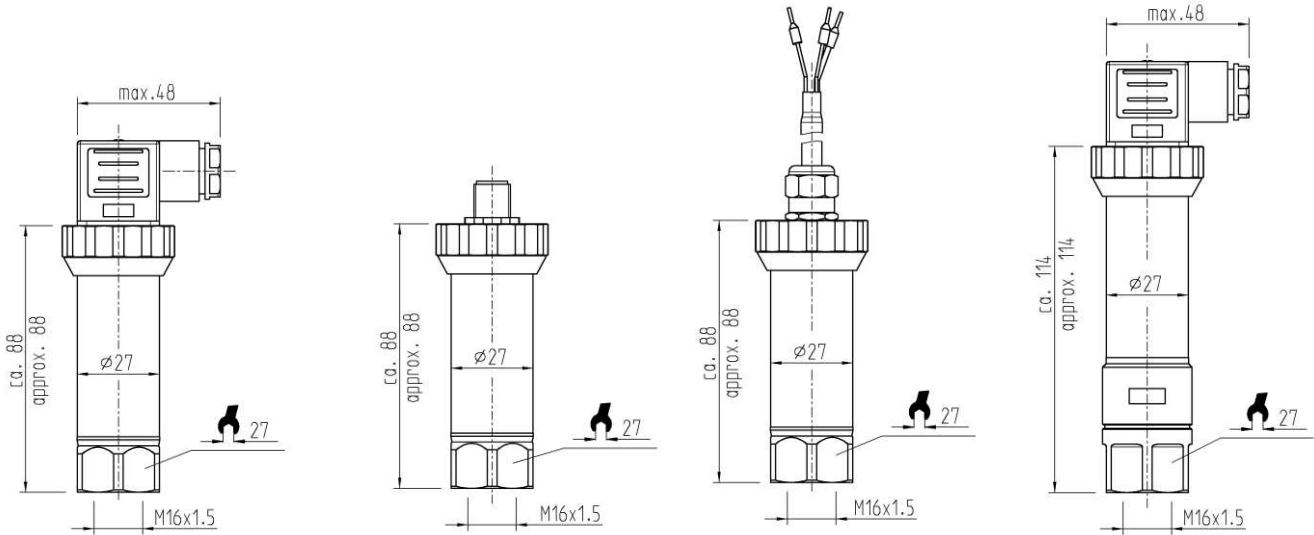

Pressure connections

M16 x 1.5 internal
with sealing cone,
(up to 7000 bar)

M20 x 1.5 internal
with sealing cone

9/16-18 UNF internal,
F250-C
(up to 7000 bar)

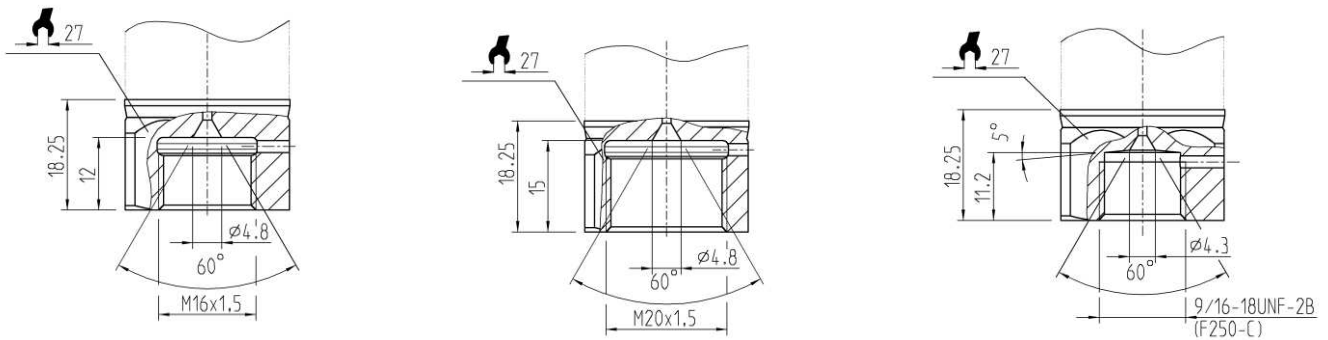

Installation and safety notes are provided in the Operating Instructions for this product.

Please take the values applicable for torque and maximum pressure from the documents provided by your high-pressure pipe supplier.

Please pay attention to the max. permissible pressure for the high-pressure pipes you are using (see information provided by the high-pressure pipe producer)

Electrical connection

Two-wire system

Plug DIN EN 175301-803A

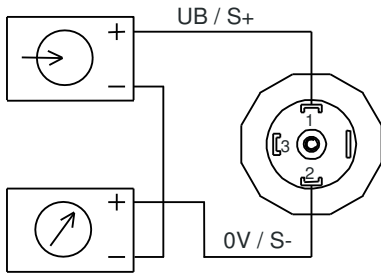

E-001

Round connector M12x1

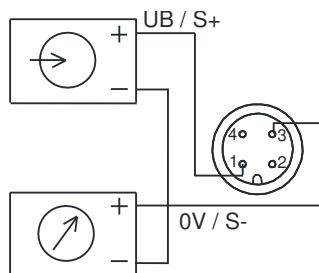

E-033

Cable outlet

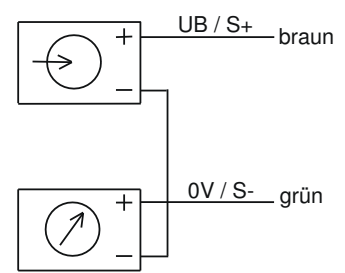

E-015

Three-wire system

Plug DIN EN 175301-803A

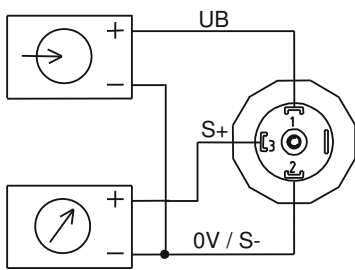

E-002

Round connector M12x1

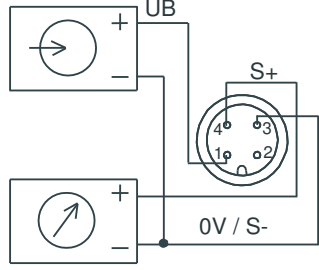

E-034

Cable outlet

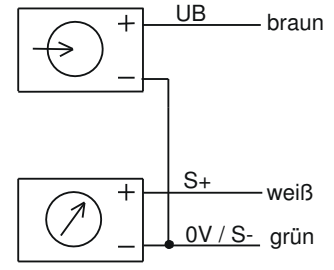

E-017

Connection table for plug or cable outlet

	4...20 mA (2-wire)			0...10VDC (3-wire)		
	Plug M12x1	DIN plug	Cable outlet	Plug M12x1	DIN plug	Cable outlet
Supply: UB+	1	1	brown	1	1	brown
Supply: 0V	3	2	green	3	2	green
Signal: S+		-	-	4	3	white
Signal: S-		-	-	3	2	green

Order details

1. Model
2. Measuring range
3. Output signal

Subject to technical changes