

Pressure-resistant Linear Position Sensor
SSI
LTX550M-F10-SSI2-GAF1-X3-H1161

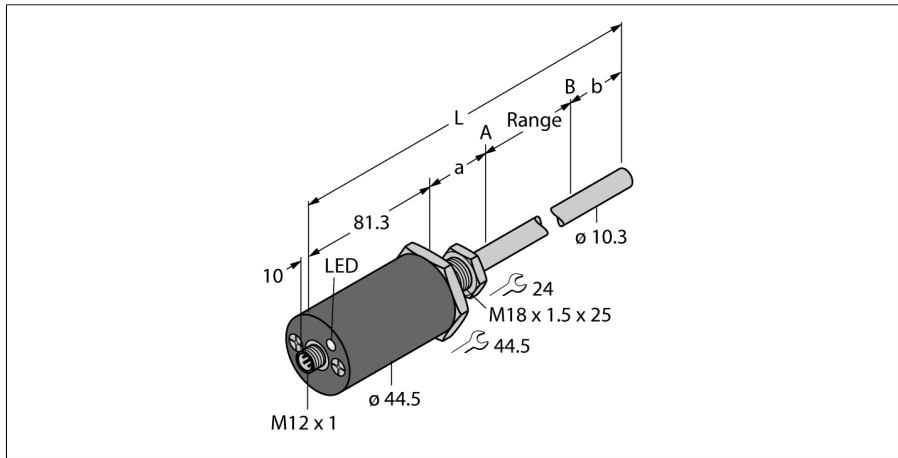

- Suited for hydraulic cylinders
- The sensor is pressure resistant up to 340 bar (permanent), 680 bar (short-term)
- Shock-proof up to 100g
- Status displayed via 3 color LED
- Resolution 0.005mm
- Operating temperature rod -40°... +105°C
- Operating temperature electronics -40°... +85°C
- Protection class IP68
- 7...30 V DC power supply
- SSI - output, gray coded, 25 bit
- M12 x 1 connector

| | |
|--------------------------------|---|
| Type code | LTX550M-F10-SSI2-GAF1-X3-H1161 |
| Ident no. | 1540234 |
| Measuring range [A...B] | 550mm |
| Resolution | 0.005 mm |
| Blind zone a | 50.8 mm |
| Blind zone b | 63.5 mm |
| Repeatability | ≥ ± 0.005 mm |
| Linearity deviation | ≤ 0.01 % f.s. |
| Hysteresis | ≤ 0.025 mm |
| Ambient temperature | -40...+85 °C |
| Operating voltage | 7... 30VDC |
| Residual ripple | ≤ 10 % U _s |
| Short-circuit protection | yes/ cyclic |
| Output function | 8-pin, SSI, 25 Bit, Gray, asynchronous, Forward |
| Current consumption | < 60 mA at 24 VDC |
| Construction | cylindrical/smooth |
| Dimensions | 745.6 mm |
| Housing material | Metal, AL |
| Active area material | Metal, VA |
| Connection | Flange connector, M12 x 1 |
| Vibration resistance | 30 Hz (1 mm) |
| Shock resistance | 100 g (11 ms) |
| Protection class | IP68 |
| Measuring range display | multifunction LED |

Wiring Diagram

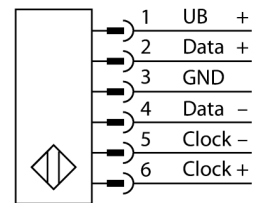

Functional principle

The LTX is a magnetostrictive sensor, optimized for precise position control in hydraulic cylinders. With the assistance of optional floats, the magnetically actuated position sensors also implement additional fill level monitoring.

The absolute value sensor is very robust and precise, and also saves the position information in the event of a voltage failure, so that additional zeroing is unnecessary. The sensors operate on the contactless function principle and are thus wear and maintenance free.

**Pressure-resistant Linear Position Sensor
SSI
LTX550M-F10-SSI2-GAF1-X3-H1161**

Accessories

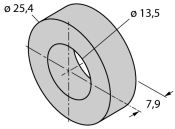
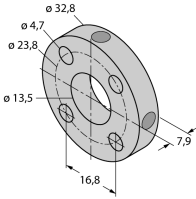
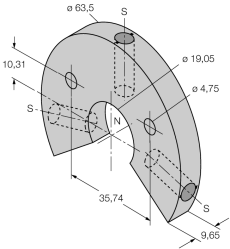
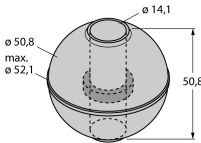
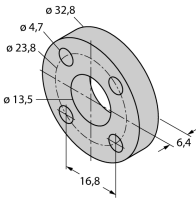
| Type code | Ident no. | Description | |
|-------------|-----------|---|---|
| CM-R10 | 6900416 | Standard positioning element, suitable for installation in hydraulic cylinders |  |
| STM-AL-R10 | 6900409 | Standard 4-hole positioning element, aluminium, suitable for installation in hydraulic cylinders |  |
| LSPM-AL-R10 | 6900414 | Ring-type positioning element with slot, aluminium, can be used for external mounting with mounting clamp RB-R10 |  |
| EF-R10 | 6900417 | Float-positioning element, stainless steel, specific weight 0.62 kg/m³, for external mounting for level monitoring |  |
| STS-R10 | 6900411 | Standard spacer suitable for non-ferritic material, for separating the positioning element from the bottom of the hydraulic piston rod, for installation in hydraulic cylinders |  |

