

Pressure-resistant Linear Position Sensor
SSI
LTX2500M-F10-SSI2-GAF1-X3-H1161

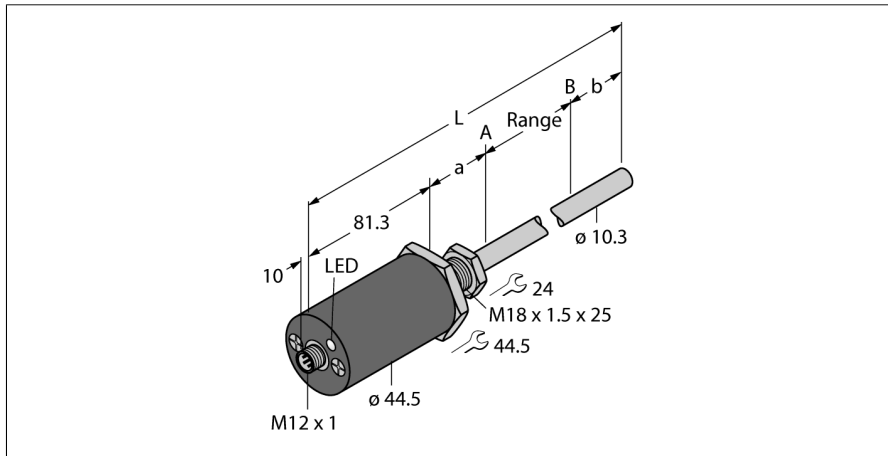

- Suited for hydraulic cylinders
- The sensor is pressure resistant up to 340 bar (permanent), 680 bar (short-term)
- Shock-proof up to 100g
- Status displayed via 3 color LED
- Resolution 0.005mm
- Operating temperature rod -40°... +105°C
- Operating temperature electronics -40°... +85°C
- Protection class IP68
- 7...30 V DC power supply
- SSI - output, gray coded, 25 bit
- M12 x 1 connector

Type code	LTX2500M-F10-SSI2-GAF1-X3-H1161
Ident no.	1540264
Measuring range [A...B]	2500mm
Resolution	0.005 mm
Blind zone a	50.8 mm
Blind zone b	63.5 mm
Repeatability	≥ ± 0.005 mm
Linearity deviation	≤ 0.01 % f.s.
Hysteresis	≤ 0.025 mm
Ambient temperature	-40...+85 °C
Operating voltage	7... 30VDC
Residual ripple	≤ 10 % U _s
Short-circuit protection	yes/ cyclic
Output function	8-pin, SSI, 25 Bit, Gray, asynchronous, Forward
Current consumption	< 60 mA at 24 VDC
Construction	cylindrical/smooth
Dimensions	2695.6 mm
Housing material	Metal, AL
Active area material	Metal, VA
Connection	Flange connector, M12 x 1
Vibration resistance	30 Hz (1 mm)
Shock resistance	100 g (11 ms)
Protection class	IP68
Measuring range display	multifunction LED

Wiring Diagram

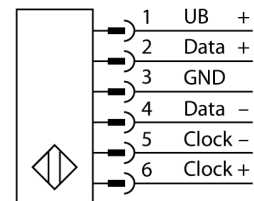

Functional principle

The LTX is a magnetostrictive sensor, optimized for precise position control in hydraulic cylinders. With the assistance of optional floats, the magnetically actuated position sensors also implement additional fill level monitoring.

The absolute value sensor is very robust and precise, and also saves the position information in the event of a voltage failure, so that additional zeroing is unnecessary. The sensors operate on the contactless function principle and are thus wear and maintenance free.

**Pressure-resistant Linear Position Sensor
SSI
LTX2500M-F10-SSI2-GAF1-X3-H1161**

Accessories

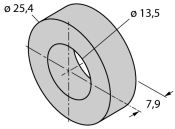
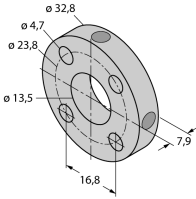
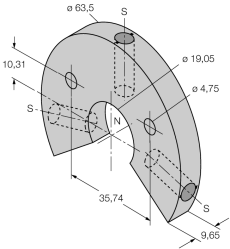
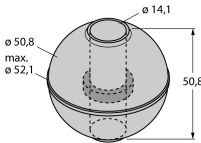
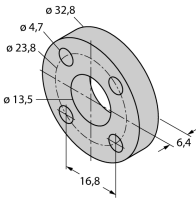
Type code	Ident no.	Description	
CM-R10	6900416	Standard positioning element, suitable for installation in hydraulic cylinders	
STM-AL-R10	6900409	Standard 4-hole positioning element, aluminium, suitable for installation in hydraulic cylinders	
LSPM-AL-R10	6900414	Ring-type positioning element with slot, aluminium, can be used for external mounting with mounting clamp RB-R10	
EF-R10	6900417	Float-positioning element, stainless steel, specific weight 0.62 kg/m³, for external mounting for level monitoring	
STS-R10	6900411	Standard spacer suitable for non-ferritic material, for separating the positioning element from the bottom of the hydraulic piston rod, for installation in hydraulic cylinders	

**Pressure-resistant Linear Position Sensor
SSI
LTX2500M-F10-SSI2-GAF1-X3-H1161**

Accessories

Type code	Ident no.	Description	
MB-R10	6900419	Mounting clamp sensor head and rod, for external mounting	
RB-R10	6900420	Mounting clamp rod, for external mounting	
MMB-R10	6900004	Mounting clamp positioning element, for external mounting	