

Pressure-resistant Linear Position Sensor
Analog
LTX125M-F10-Li0-X3-H1151

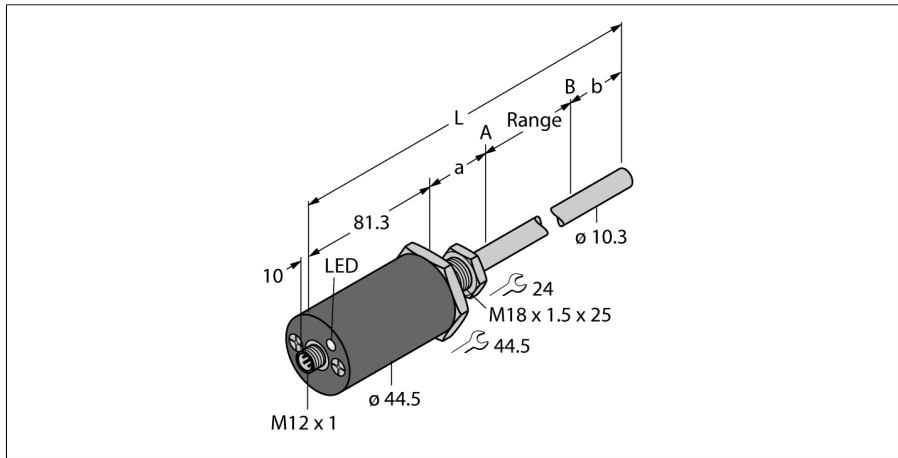

- Suited for hydraulic cylinders
- The sensor is pressure resistant up to 340 bar (permanent), 680 bar (short-term)
- Shock-proof up to 100g
- Status displayed via 3 color LED
- 16 bit resolution
- adjustable measuring range
- Operating temperature rod -40°... +105°C
- Operating temperature electronics -40°... +85°C
- Protection class IP68
- 7...30 V DC power supply
- Analog output 4...20 mA
- M12 x 1 connector

Type code	LTX125M-F10-Li0-X3-H1151
Ident no.	1540276
Measuring principle	Magnetostrictive
Measuring range [A...B]	125 mm
Resolution	16 bit
Blind zone a	50.8 mm
Blind zone b	63.5 mm
Repeatability	≥ ± 0.005 mm
Linearity deviation	≤ 0.01 % f.s.
Hysteresis	≤ 0.025 mm
Ambient temperature	-40...+85 °C
Operating voltage	7... 30VDC
Residual ripple	≤ 10 % U _{ss}
Short-circuit protection	yes/ cyclic
Output function	5-pin, Analog output
Current output	4...20mA
Load resistance, current output	≤ 0.5 kOhm
Current consumption	< 60 mA at 24 VDC
Construction	cylindrical/smooth
Dimensions	320.6 mm
Housing material	Metal, AL
Active area material	Metal, VA
Connection	Flange connector, M12 x 1
Vibration resistance	30 Hz (1 mm)
Shock resistance	100 g (11 ms)
Protection class	IP68
Measuring range display	multifunction LED

Wiring Diagram

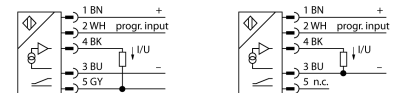

Functional principle

The LTX is a magnetostrictive sensor, optimized for precise position control in hydraulic cylinders. With the assistance of optional floats, the magnetically actuated position sensors also implement additional fill level monitoring.

The absolute value sensor is very robust and precise, and also saves the position information in the event of a voltage failure, so that additional zeroing is unnecessary. The sensors operate on the contactless function principle and are thus wear and maintenance free.

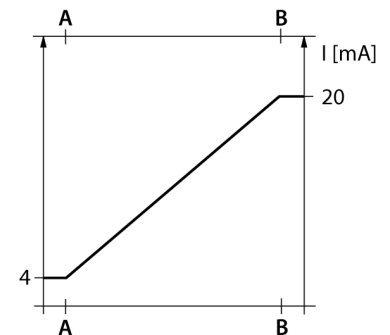

**Pressure-resistant Linear Position Sensor
Analog
LTX125M-F10-Li0-X3-H1151**

Accessories

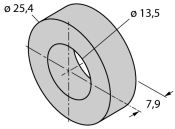
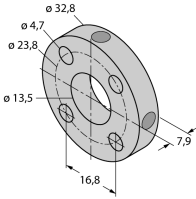
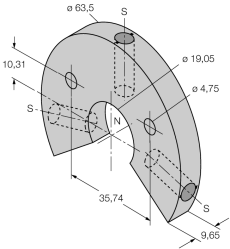
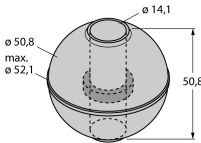
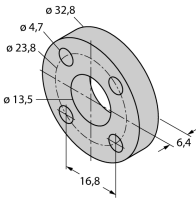
Type code	Ident no.	Description	
CM-R10	6900416	Standard positioning element, suitable for installation in hydraulic cylinders	
STM-AL-R10	6900409	Standard 4-hole positioning element, aluminium, suitable for installation in hydraulic cylinders	
LSPM-AL-R10	6900414	Ring-type positioning element with slot, aluminium, can be used for external mounting with mounting clamp RB-R10	
EF-R10	6900417	Float-positioning element, stainless steel, specific weight 0.62 kg/m³, for external mounting for level monitoring	
STS-R10	6900411	Standard spacer suitable for non-ferritic material, for separating the positioning element from the bottom of the hydraulic piston rod, for installation in hydraulic cylinders	

Pressure-resistant Linear Position Sensor
Analog
LTX125M-F10-Li0-X3-H1151

TURCK

Industrial
Automation

Accessories

Type code	Ident no.	Description	
RKC4T-2-RSC4.301T/ TX320	6630836	Adapter cable, 3-pin, for direct connection of the sensor to the block I/O module TBEN-S2-4AI, required module parameter setting: common ground (asymmetrical)	<p>The diagram shows a 3-pin adapter cable with two M12x1 connectors. The left connector has a length of 11.5 mm from the end to the start of the cable body. The total length of the cable body is 42 mm. The right connector has a length of 18.2 mm from the end to the start of the cable body. The total length of the cable body is 49.5 mm. The diameter of the cable body is 15 mm (ø 15). The length of the cable body is L.</p>