

**L-Series**  
Start-Stop Interface

**Temposonics-LH**  
Measuring length 50 - 3000 mm



*Superior Precision*

**High Pressure Stainless Steel Sensor  
with 100°C Electronics**

Linear, Absolute Measurement

Contactless Sensing with Highest Durability

Rugged Industrial Sensor, EMC shielded and CE certified

Linearity Tolerance better 0,02 %

Repeatability 0,001 %

Start/Stop Pulse Transmission

Operating Temperature up to 100° C



...the measurable difference

**Magnetostriction**

The *absolute Tempsonics*® linear position sensors are based on the MTS developed *magnetostrictive* measurement principle. That combines various magneto-mechanical effects and uses the physical high precise speed-measurement of an ultrasonic wave (torsion pulse in its sensor element) for position detecting. Sensor integrated signal processing transforms the measurements directly into market standard outputs. The *contactless* principle - an external movable magnet marks the position - eliminates the wear, noise and erroneous signal problems and guarantees the best durability without any recalibration.

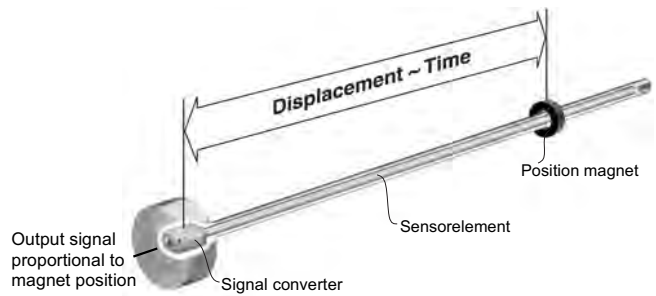

**Operating principle:**  
Magnetostrictive ultrasonic speed measurement = Position sensing

**Technical Data**

**Input**

Measured variable                      Displacement  
Measuring range                         50 - 3000 mm

**Output**

Start-Stop pulse                         RS 422 differential signal

**Accuracy**

- Resolution                                0,1 mm / 0,01 mm / 0,005 mm (controller dependent)  
- Linearity                                 < ± 0,02 % F.S. (Minimum ± 50 µm)  
- Repeatability                            < ± 0,001 % F.S.  
- Update frequency                      Controller dependent

**Operating conditions**

Magnet speed                            Any  
Operating pressure                      350 bar (530 bar peak pressure)  
Operating temperature                 -40 °C ... +100 °C  
Dew point, humidity                    90% rel. humidity, no condensation  
Sealing                                      IP67 if mating connector is correctly fitted  
Shock test                                 100 g single hit, IEC-Standard 68-2-27  
Vibration test                             10 g / 10 - 2000 Hz, IEC-Standard 68-2-6  
Norms, EMC test                        Electromagnetic emission EN 50081-1  
    Electromagnetic immunity EN 50082-2  
    EN 61000, Criteria A, CE-qualified

**Form factor, material**

Sensor head                                Aluminum  
Rod with flange                            Stainless steel 1.4301 / AISI 304  
Position transmitter                      Ring- or U-Magnet

**Installation**

Mounting position                        Any  
Rod    Threaded flange M18 x 1,5 or 3/4" -16 UNF-3A, hex nut M18  
Magnet                                        Mounting plate and screws: amagnetic

**Electrical connection**

Connection type                         6 pin connector M16 or 2 m cable outlet  
Input voltage                               24 VDC (-15 / +20 %)  
Current consumption                    100 mA typical  
Ripple                                        < 1 % peak-peak  
Electric strength                         500 V (DC ground to machine ground)

**Formfactor**

The extremely robust sensor, ideal for continuous operation under harshest industrial conditions is completely modular in mechanics and electronics design.

- A rod-shaped sensor housing protects the sensing element in which gives rise to the measurement signal.
- The sensor head accommodates the complete modular electronics interface with active signal conditioning. Double encapsulation ensures high operating safety and optimum EMC protection.
- The position transmitter, a permanent magnet - fixed at the mobile machine part - drives contactlessly over the sensor's stroke and starts measuring through the housing wall.

**Temposonics-LH ... high pressure rod design**
**Measuring length 50 - 3000 mm**

Temposonics-LH with pressure-resistant stainless steel flange and sensing rod is suitable for use in hydraulic cylinders and externally in all applications where space is a problem. Position measurement is via ring or U-magnets travelling along the sensing rod without any mechanical contact.

**Advantage...**

the completely operable sensor cartridge can be replaced for servicing easily without opening the fluid circuit.

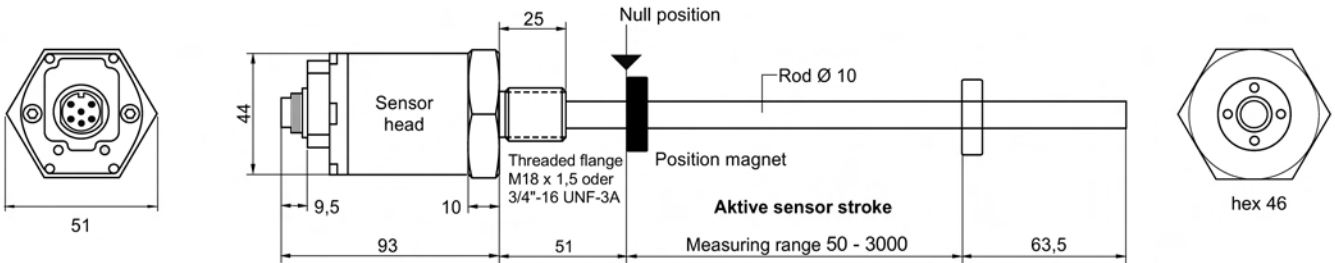

All dimensions in mm

**Connection types**

**Connector outlet D600**  
6 pin male connector M16

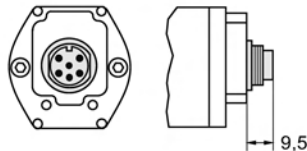

**Cable outlet R002**

Max. operating temperature: 70° C  
6 wires PVC cable, 3 x 2 x 0,14 mm<sup>2</sup>  
shield, cable-Ø 6 mm, bending radius  
50 mm at fixed installation

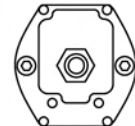

**Cable outlet T002**

Max. operating temperature: 150° C  
8 wires Teflon cable, 4 x 2 x 0,25 mm<sup>2</sup>  
shield, cable-Ø 7,5 mm, bending radius  
75 mm at fixed installation

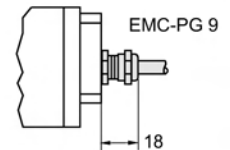
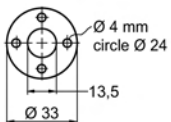
**Available position magnets (pls. order separately)**

**Ring magnet OD33 (standard)**  
Part No. 201 542-2  
Height: 8 mm  
Composite PA-ferrite-GF20  
weight ca. 14 g, operating  
temperature -40...+100° C

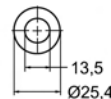

**Ring magnet OD25,4**  
Part No. 400 533  
Height: 8 mm  
Composite PA-Ferrite,  
weight ca. 10 g, operating  
temperatur -40...+100° C

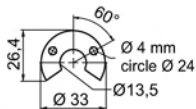

**U-magnet OD33**  
Part No. 251 416-2  
Height: 8 mm  
Composite PA-ferrite-GF20  
weight ca. 11 g, operating  
temperature -40...+100° C

**Start/Stop output**

Digital Temposonics-LH is equipped with a start/stop output. The sensor requires a start signal from an external indicator in the control system and returns a signal corresponding to the magnet position. The time elapsed between the two signals is proportional to the magnet position, i.e. to the displacement. Time measurement is by the controller and used for calculating the position value.

**Logic diagram**

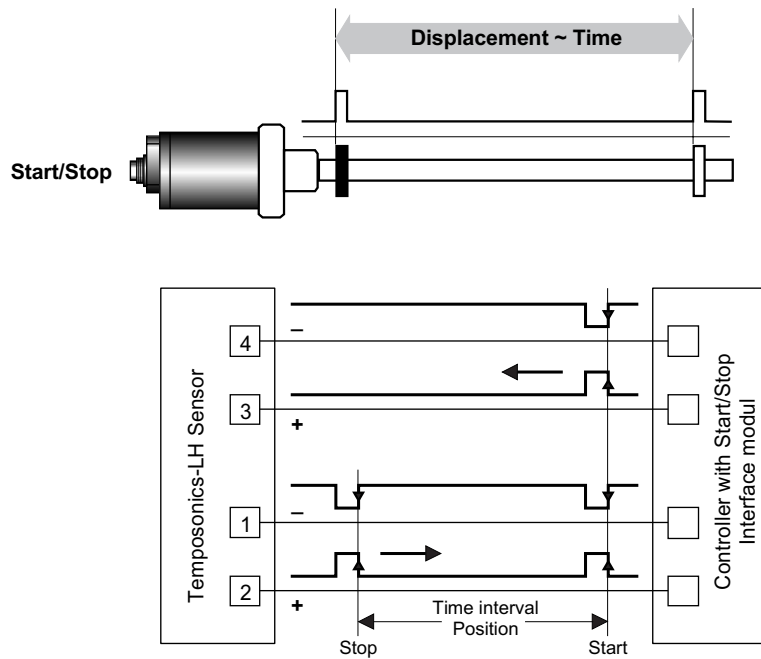

**Linearity protocol**

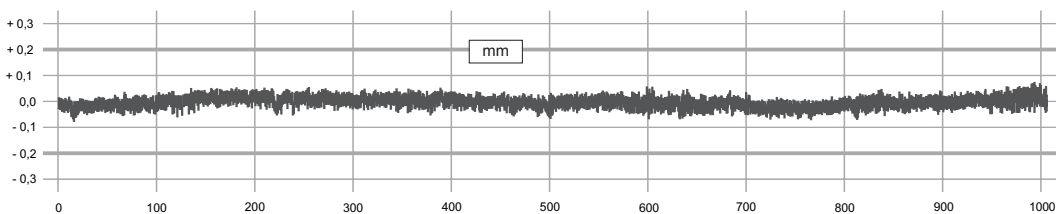

Sensor Temposonics-LH, stroke length 1000 mm  
 Tolerance allowed:  $\pm 0,2$  mm  
 Tolerance measured:  $\pm 0,09$  mm uncorrected

## Variable mounting in any position

### Rod

Mount the sensor directly via flange or by means of the nut packed with the sensor. If possible, non-magnetizable material should be used for the sensor mounting component. Taking the mounting dimensions shown right into account is indispensable.

### Position magnet

To have a neat magnetic field for measurement, antimagnetic material must be used for the position magnet mounting component (screws, spacers, etc.).

### Horizontal installation

With horizontal mounting, sensors with a measuring length from 1 meter must be provided with mechanical support at the rod end, and with supports distributed regularly over the length if the measuring rod is very long. In this case, open ring magnets must be used as position transmitter.

### Hydraulic sealing

Recommended is sealing of the flange facing with an O-Ring (e.g. 22,4 x 2,65) in a cylinder cover nut.

### Sample: Sensor support

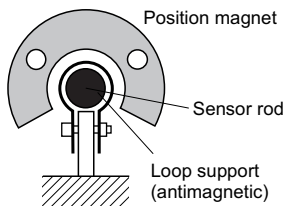

## Minimum assembly distance

### 1. Non-magnetizable material

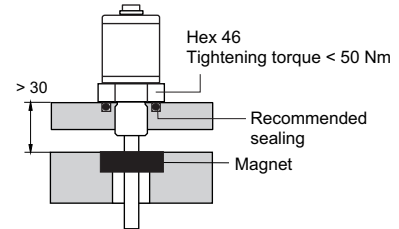

### 2. Magnetizable material

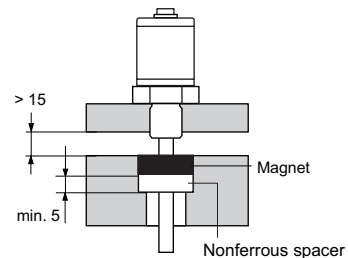

## Cylinder installation

Due to form factor, a rod sensor is excellently suited for direct stroke measurement in fluid cylinders. The magnet, mounted on the piston bottom, drives contactlessly along the stroke and marks exactly the position through the rod wall - independent of the used hydraulic fluid - that guarantees a longlife and trouble-free operation.

The sensor cartridge can be removed from the flange and rod housing while still installed in the cylinder. This procedure allows quick and easy sensor cartridge replacement, without the loss of hydraulic pressure.

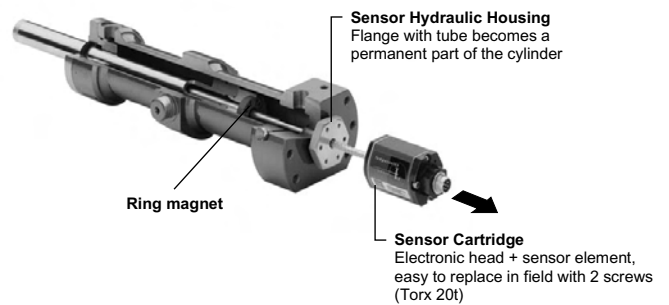

### Notes

- Magnet must not slide along the sensor tube
- Bore in the piston rod and type of sealing depends on pressure and piston velocity (13 mm min.)
- Do not exceed peak pressure
- Protect sensor rod from wear

**Wiring**

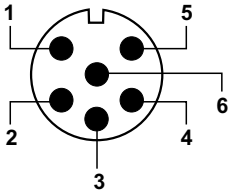

Pin	Cable color	Function
1	gray	Stop (-)
2	pink	Stop (+)
3	yellow	Start (+)
4	green	Start (-)
5	brown	+ 24 Vdc ( $\pm 10\%$ )
6	white	DC Ground (0 V)

View:  
Front face of sensor plug  
rear of mating connector

**Mating connectors** (recommended, not on delivery)

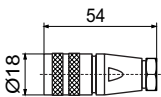

6 pin female connector M16, PG 7  
**Part No. STC0 9131 D**

6 pin female connector M16, PG 9  
**Part No. STC0 9131 D06 PG9**

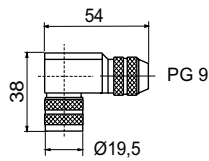

6 pin 90° female connector M16  
Insert adjustable in 45° positions  
**Part No. STC0 9131-6**

Housing: Zinc, nickel plated  
Termination: Solder  
Contact insert: Silver plated  
Cable clamp: PG 7 / 9

**Ordering Code**

**Position sensor Temposonics**      L H    ■    ■    ■    ■    ■    M    ■    ■    ■    ■    ■    2    ■    ■    ■

**Sensor model** \_\_\_\_\_

**Form factor** \_\_\_\_\_  
**M** - Flange M18 x 1,5 (Standard)  
**S** - Flange 3/4" - 16 UNF - 3A

**Connection type** \_\_\_\_\_  
**D600** - 6 pin connector M16  
**R002** - 2 m PVC cable w/o connector, Option: R001-R010 (1-10 m)  
**T002** - 2 m Teflon cable w/o connector, Option: T001-T010 (1-10 m)

**Measuring range** \_\_\_\_\_  
0050...3000 mm  
Standard: up to 1000 in 50 mm, greater 1000 in 250 mm steps  
Other length upon request

**Input voltage** \_\_\_\_\_  
**2** - +24 VDC

**Output** \_\_\_\_\_  
**R2** - Start-Stop (100° C)

**On delivery: Sensor, hex nut, pls. order magnet (see below) separately.**

<b>Accessories</b>	<b>Part-Nr.</b>
Ring magnet OD33, Standard	201 542-2
Ring magnet OD25,4	400 533
U-Magnet OD33	251 416-2
6 pin mating connector M16, PG7	ST C0 9131D
6 pin matingconnector M16, PG9	ST C0 9131D06 PG9
6 pin 90° female mating connector M16	ST C0 9131-6
PVC cable 3 x 2 x 0,14 mm <sup>2</sup>	K27
Teflon cable, temperature resistance 100° C, 4 x 2 x 0,25 mm <sup>2</sup>	K34

**Document Part Number: OEM.101005e**

MTS and Temposonics® are registered trademarks of MTS Systems Corporation. All other trademarks are the property of their respective owners. Printed in Germany.

Copyright © 2013 MTS Sensor Technologie GmbH & Co. KG. Alterations reserved. All rights reserved in all media. No license of any intellectual property rights is granted. The information is subject to change without notice and replaces all data sheets previously supplied. The availability of components on the market is subject to considerable fluctuation and to accelerated technical progress. Therefore we reserve the right to alter certain components of our products depending on their availability. In the event that product approbations or other circumstances related to your application do not allow a change in components, a continuous supply with unaltered components must be agreed by specific contract.



**MTS Sensor Technologie  
GmbH & Co. KG**  
Auf dem Schüffel 9  
58513 Lüdenscheid, Germany  
Tel. + 49-23 51-95 87 0  
Fax + 49-23 51-5 64 91  
E-Mail: [info@mtssensor.de](mailto:info@mtssensor.de)  
[www.mtssensor.de](http://www.mtssensor.de)

**MTS Systems Corporation**  
Sensors Division  
3001 Sheldon Drive  
Cary, N.C. 27513, USA  
Tel. + 1-919-677-0100  
Fax + 1-919-677-0200  
E-Mail: [sensorsinfo@mts.com](mailto:sensorsinfo@mts.com)  
[www.mtssensors.com](http://www.mtssensors.com)

**MTS Sensors Technology Corp.**  
737 Aihara-cho,  
Machida-shi, Japan  
Tel. + 81-42-775-3838  
Fax + 81-42-775-5516  
E-Mail: [info@mtssensor.co.jp](mailto:info@mtssensor.co.jp)  
[www.mtssensor.co.jp](http://www.mtssensor.co.jp)